



SERVICE MANUAL

THE TRANSCEIVER

IC-7800

INTRODUCTION

This service manual describes the latest service information for the **IC-7800** THE TRANSCEIVER at the time of publication.

MODEL	SYMBOL	VERSION
IC-7800	USA	U.S.A.
	EUR	Europe
	FRA	France
	ITR	Italy
	KOR	Korea
	ESP	Spain
	UK	United Kingdom

To upgrade quality, any electrical or mechanical parts and internal circuits are subject to change without notice or obligation.

DANGER

NEVER connect the transceiver to an DC power supply or to an AC outlet that uses more than 265 V. This will ruin the transceiver.

DO NOT expose the transceiver to rain, snow or any liquids.

DO NOT reverse the polarities of the power supply when connecting the transceiver.

DO NOT apply an RF signal of more than 20 dBm (100 mW) to the antenna connector. This could damage the transceiver's front end.



ORDERING PARTS

Be sure to include the following four points when ordering replacement parts:

1. 10-digit order numbers
2. Component part number and name
3. Equipment model name and unit name
4. Quantity required

<SAMPLE ORDER>

1110003870 S.IC NJM2058M IC-7800 MAIN UNIT 5 pieces
8810008450 Screw BIH M4x8 ZK IC-7800 Top cover 10 pieces

Addresses are provided on the inside back cover for your convenience.

REPAIR NOTES

1. Make sure a problem is internal before disassembling the transceiver.
2. **DO NOT** open the transceiver until the transceiver is disconnected from its power source.
3. **DO NOT** force any of the variable components. Turn them slowly and smoothly.
4. **DO NOT** short any circuits or electronic parts. An insulated tuning tool **MUST** be used for all adjustments.
5. **DO NOT** keep power ON for a long time when the transceiver is defective.
6. **DO NOT** transmit power into a signal generator or a sweep generator.
7. **ALWAYS** connect a 50 dB to 60 dB attenuator between the transceiver and a deviation meter or spectrum analyzer when using such test equipment.
8. **READ** the instructions of test equipment thoroughly before connecting equipment to the transceiver.

Icom, Icom Inc. and **ICOM** are registered trademarks of Icom Incorporated (Japan) in the United States, the United Kingdom, Germany, France, Spain, Russia and/or other countries.

TABLE OF CONTENTS

SECTION 1 SPECIFICATIONS

SECTION 2 INSIDE VIEWS

2 - 1	UPPER LAYER	2 - 1
2 - 2	UNDER LAYER	2 - 1
2 - 3	TOP VIEW	2 - 2
2 - 4	BOTTOM VIEW	2 - 2
2 - 5	MAIN UNIT	2 - 3
2 - 6	DSP-A/DSP-B BOARD	2 - 4
2 - 7	DSP-TX BOARD	2 - 4
2 - 8	LOGIC UNIT	2 - 5
2 - 9	SCOPE UNIT	2 - 5
2 - 10	RXPLL-A UNIT	2 - 6
2 - 11	RXPLL-B UNIT	2 - 6
2 - 12	OSC UNIT	2 - 7
2 - 13	PA200W BOARD	2 - 7

SECTION 3 CIRCUIT DESCRIPTION

SECTION 4 ADJUSTMENT PROCEDURES

SECTION 5 PARTS LIST

SECTION 6 MECHANICAL PARTS AND DISASSEMBLY

SECTION 7 SEMI-CONDUCTOR INFORMATION

SECTION 8 BOARD LAYOUTS

8 - 1	DISPLAY BOARD	8 - 1
8 - 2	SW-A BOARD	8 - 3
8 - 3	SW-B BOARD	8 - 3
8 - 4	SW-C BOARD	8 - 3
8 - 5	VR-A BOARD	8 - 5
8 - 6	VR-B BOARD	8 - 5
8 - 7	VR-C BOARD	8 - 5
8 - 8	VR-D BOARD	8 - 5
8 - 9	JACK BOARD	8 - 5
8 - 10	MIC BOARD	8 - 5
8 - 11	CF BOARD	8 - 5
8 - 12	TENKEY BOARD	8 - 7
8 - 13	LED BOARD	8 - 7
8 - 14	PBT1 BOARD	8 - 7
8 - 15	PBT2 BOARD	8 - 7
8 - 16	LOGIC UNIT	8 - 9
8 - 17	MEMORY BOARD	8 - 11
8 - 18	MAIN UNIT	8 - 13
8 - 19	DSP-A/DSP-B BOARDS	8 - 15

8 - 21	SCOPE UNIT	.8 - 19
8 - 22	RXPLL-A UNIT	.8 - 21
8 - 23	RXPLL-B UNIT	.8 - 23
8 - 24	DIGISEL UNIT	.8 - 25
8 - 25	OSC UNIT	.8 - 27
8 - 26	ANT-SW UNIT	.8 - 29
8 - 27	FILTER UNIT	.8 - 31
8 - 28	NETWORK BOARD	.8 - 33
8 - 29	CTRL BOARD	.8 - 35
8 - 30	BPF UNIT	.8 - 37
8 - 31	PA200W BOARD	.8 - 39
8 - 32	DC-DC UNIT	.8 - 41

SECTION 9 BLOCK DIAGRAMS

SECTION 10 WIRING DIAGRAMS

SECTION 11 VOLTAGE DIAGRAMS

11 - 1	DISPLAY BOARD	.11 - 1
11 - 2	CF BOARD	.11 - 1
11 - 3	SW-A BOARD	.11 - 2
11 - 4	VR-B BOARD	.11 - 2
11 - 5	VR-C BOARD	.11 - 2
11 - 6	VR-A BOARD	.11 - 2
11 - 7	MIC BOARD	.11 - 2
11 - 8	JACK BOARD	.11 - 2
11 - 9	VR-D BOARD	.11 - 2
11 - 10	SW-B BOARD	.11 - 2
11 - 11	TENKEY BOARD	.11 - 3
11 - 12	SW-C BOARD	.11 - 4
11 - 13	PBT1 BOARD	.11 - 4
11 - 14	PBT2 BOARD	.11 - 4
11 - 15	LED BOARD	.11 - 4
11 - 16	LOGIC UNIT AND MEMORY BOARD	.11 - 5
11 - 17	MAIN UNIT	.11 - 9
11 - 18	DSP-A/DSP-B BOARDS	.11 - 12
11 - 19	DSP-TX BOARD	.11 - 13
11 - 20	SCOPE UNIT	.11 - 14
11 - 21	RXPLL-A/RXPLL-B UNITS	.11 - 18
11 - 22	DIGISEL UNIT	.11 - 21
11 - 23	OSC UNIT	.11 - 23
11 - 24	ANT-SW UNIT	.11 - 24
11 - 25	FILTER UNIT	.11 - 24
11 - 26	BPF UNIT	.11 - 25
11 - 27	NETWORK BOARD	.11 - 26
11 - 28	CTRL BOARD	.11 - 27
11 - 29	PA200W BOARD	.11 - 28
11 - 30	DC-DC UNIT	.11 - 29

SECTION 1 SPECIFICATIONS

■ GENERAL

- Frequency coverage:

Receive	0.030–60.000 MHz ^{*1, *2}	
Transmit	1.800–1.999 MHz ^{*2}	3.500–3.999 MHz ^{*2}
	5.332, 5.348, 5.368, 5.373, 5.405 MHz ^{*2}	
	7.000–7.300 MHz ^{*2}	10.100–10.150 MHz ^{*2}
	14.000–14.350 MHz ^{*2}	18.068–18.168 MHz ^{*2}
	21.000–21.450 MHz ^{*2}	24.890–24.990 MHz ^{*2}
	28.000–29.700 MHz ^{*2}	50.000–54.000 MHz ^{*2}

^{*1} Some frequency bands are not guaranteed.
^{*2} Depending on version.
- Mode : USB, LSB, CW, RTTY, AM, FM, PSK31
- Number of memory channels : 101 (99 regular, 2 scan edges)
- Antenna connector : SO-239 × 4 and phono [(RCA); 50 Ω]
- Usable temp. range: 0°C to +50°C (32°F to 122°F)
- @Frequency stability : Less than ±0.5 ppm from 1 min. after power ON.
- Freq. resolution : 1 Hz
- Power supply : AC 85 V–265 V (negative ground) voltage
- Current drain :

Transmit	max. power	800 VA
Receive	stand-by	200 VA (typical)
	max. audio	210 VA (typical)
- Dimensions : 424 (W) × 149(H) × 435(D) mm (Proj. not included) 16 1/16(W) × 5 7/8(H) × 17 1/8(D) in
- Weight : Approximate 25 kg (57 lb 6 oz)
- ACC 1 connector : 8-pin DIN connector
- ACC 2 connector : 7-pin DIN connector
- CI-V connector : 2-conductor 3.5(d) mm (1/8")
- Display : 7-inch wide TFT color LCD

■ TRANSMITTER

- Output power :

HF: SSB/CW/RTTY/FM/PSK31	5–200 W
AM	5–50 W
137 kHz: CW	More than –20 dBm
- Modulation system :

SSB	PSN modulation
AM	Low power modulation
FM	Phase modulation
- Spurious emission : More than 60 dB (HF bands)
More than 70 dB (50 MHz band)
- Carrier suppression: More than 63 dB
- Unwanted sideband suppression: More than 80 dB
- Mic. connector : 8-pin connector (600 Ω)
- ELE-KEY connector: 3-conductor 6.35(d) mm (1/4")
- KEY connector : 3-conductor 6.35(d) mm (1/4")
- SEND connector : Phono (RCA)
- ALC connector : Phono (RCA)

■ RECEIVER

- Receive system : Triple-conversion superheterodyne
- Intermediate frequencies:

1st IF frequency	64.455 MHz
2nd IF frequency	455 kHz
3rd IF frequency	36 kHz
- Sensitivity (Typ.) :

SSB, CW, RTTY (at 2.4 kHz bandwidth)	
0.1–1.799 MHz ^{*1}	0.5 μV (10 dB S/N)
1.8–29.99 MHz ^{*1}	0.16 μV (10 dB S/N)
50.0–54.0 MHz ^{*2}	0.13 μV (10 dB S/N)
AM (at 6.0 kHz bandwidth)	
0.1–1.799 MHz ^{*1}	6.3 μV (10 dB S/N)
1.8–29.99 MHz ^{*1}	2.0 μV (10 dB S/N)
50.0–54.0 MHz ^{*2}	1.0 μV (10 dB S/N)
FM (at 15 kHz bandwidth)	
28.0–29.99 MHz ^{*1}	0.5 μV (12 dB SINAD)
50.0–54.0 MHz ^{*2}	0.32 μV (12 dB SINAD)

^{*1} Pre-amp1 is ON ^{*2} Pre-amp2 is ON
- Internal Modulate Distortion (Typ.)
Dynamic range is 109 dB at 100 MHz, 100 kHz separation (Pre-amp1 and Pre-amp2 are OFF).
- Squelch sensitivity : (Pre-amp OFF)

SSB/CW/RTTY/PSK31	Less than 5.6 μV
FM	Less than 1.0 μV
- Selectivity :

SSB/RTTY (at 2.4 kHz bandwidth)	
	More than 2.4 kHz/–3 dB
	Less than 3.6 kHz/–60 dB
CW (at 500 Hz bandwidth)	
	More than 500 Hz/–3 dB
	Less than 700 Hz/–60 dB
AM (at 6 kHz bandwidth)	
	More than 6.0 kHz/–3 dB
	Less than 15.0 kHz/–60 dB
FM (at 15 kHz bandwidth)	
	More than 12 kHz/–6 dB
	Less than 20 kHz/–60 dB
- Spurious and image rejection response ratio: More than 70 dB
- RIT variable range : ±9.999 kHz
- Audio output power : More than 2.6 W at 10 % distortion with an 8 Ω load
- PHONES connector: 3-conductor 6.35 (d) mm (1/4")
- EXT SP connector : 2-conductor 3.5 (d) mm (1/8") 8 Ω

■ ANTENNA TUNER

- Output matching range:

HF bands	16.7 to 150 Ω unbalanced ^{*1}
50 MHz band	20 to 125 Ω unbalanced ^{*2}

^{*1} Less than VSWR 3:1; ^{*2} Less than VSWR 2.5:1
- Minimum operating input power:

HF bands	: 8 W
50 MHz band	: 15 W
- Tuning accuracy : VSWR 1.5:1 or less
- Insertion loss : Less than 1.0 dB (after tuning)

All stated specifications are subject to change without notice or obligation.

SECTION 2 INSIDE VIEWS

2-1 UPPER LAYER

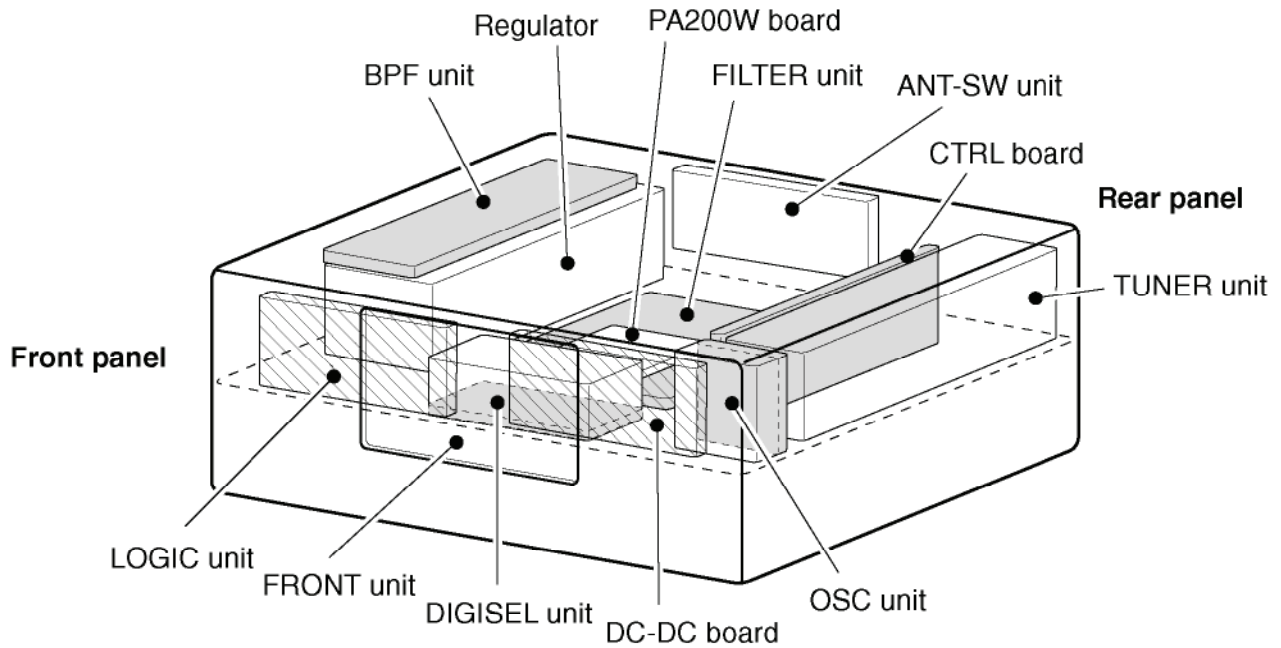

2-2 UNDER LAYER

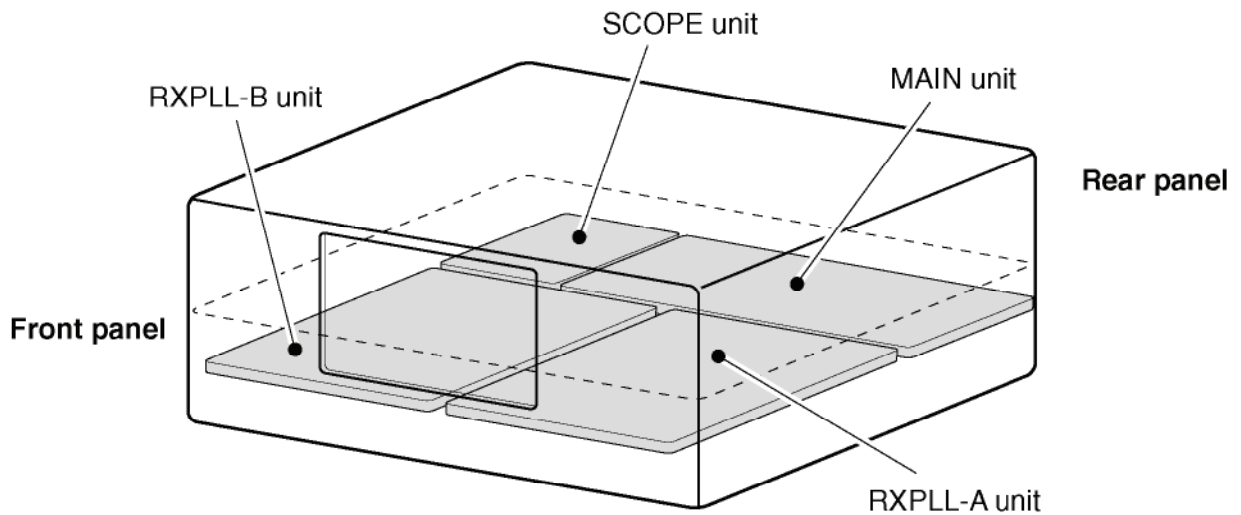

2-3 TOP VIEW

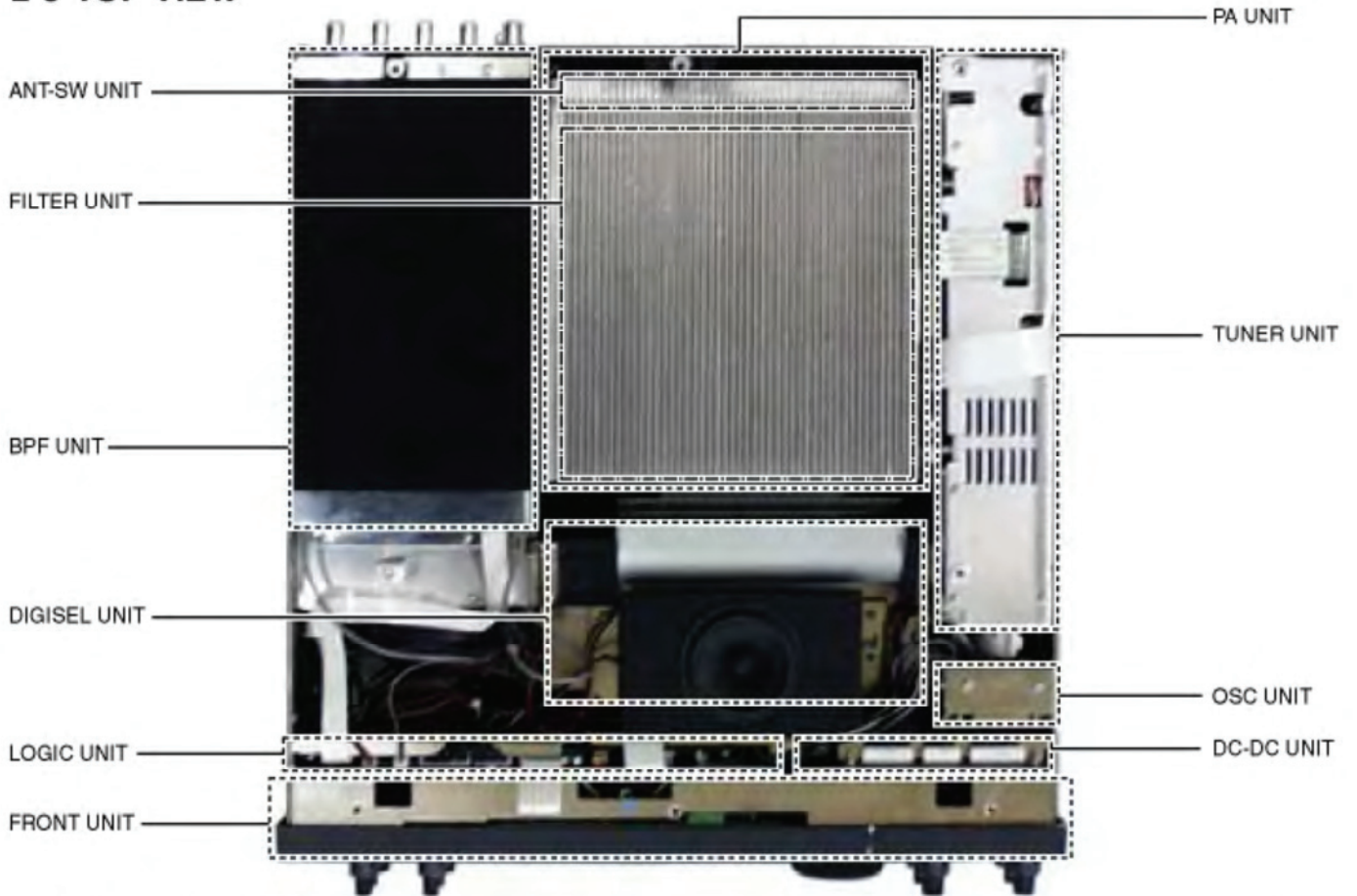

2-4 BOTTOM VIEW

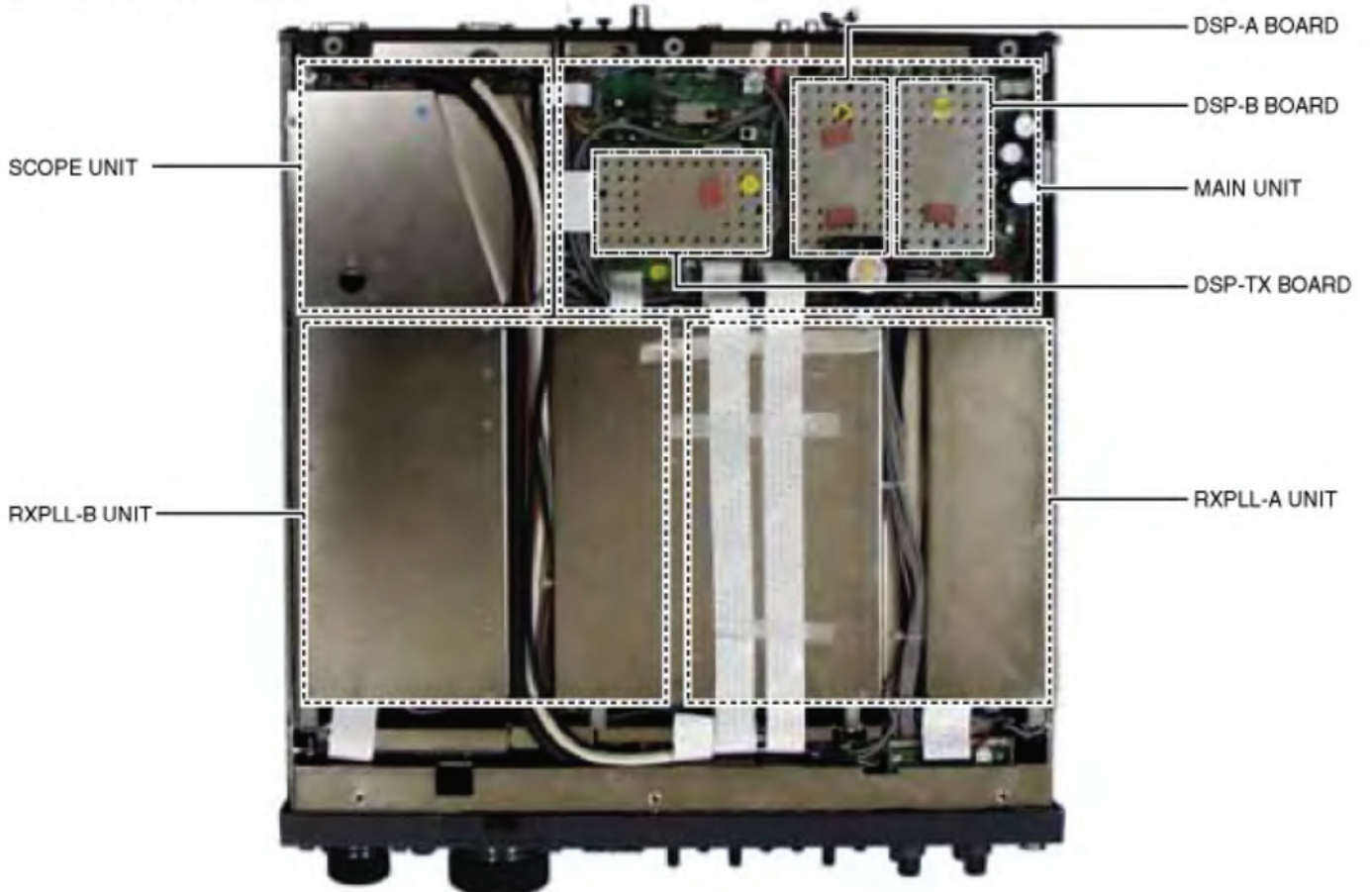

2-5 MAIN UNIT

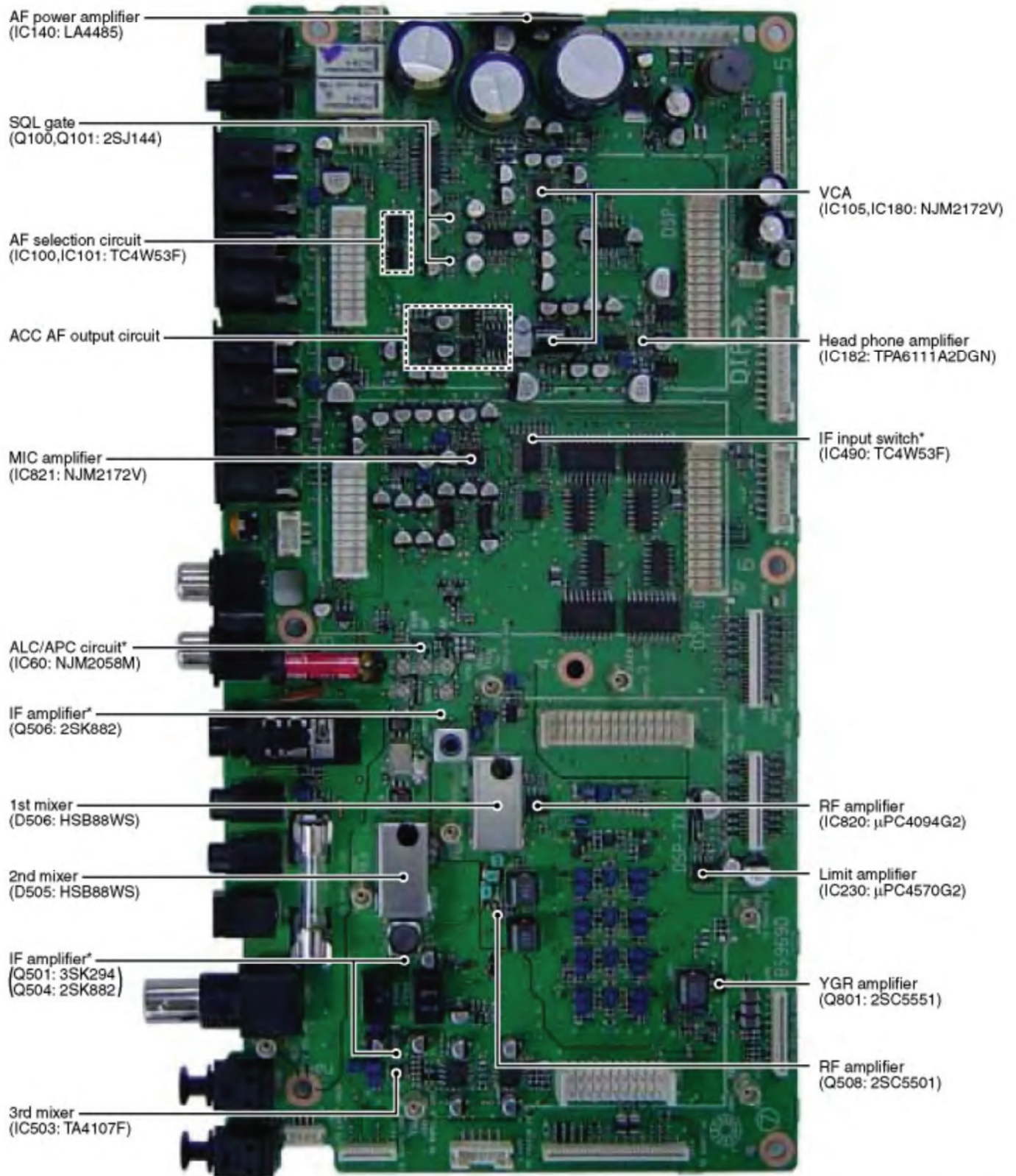

*Located under side of the point

2-6 DSP-A/DSP-B BOARDS

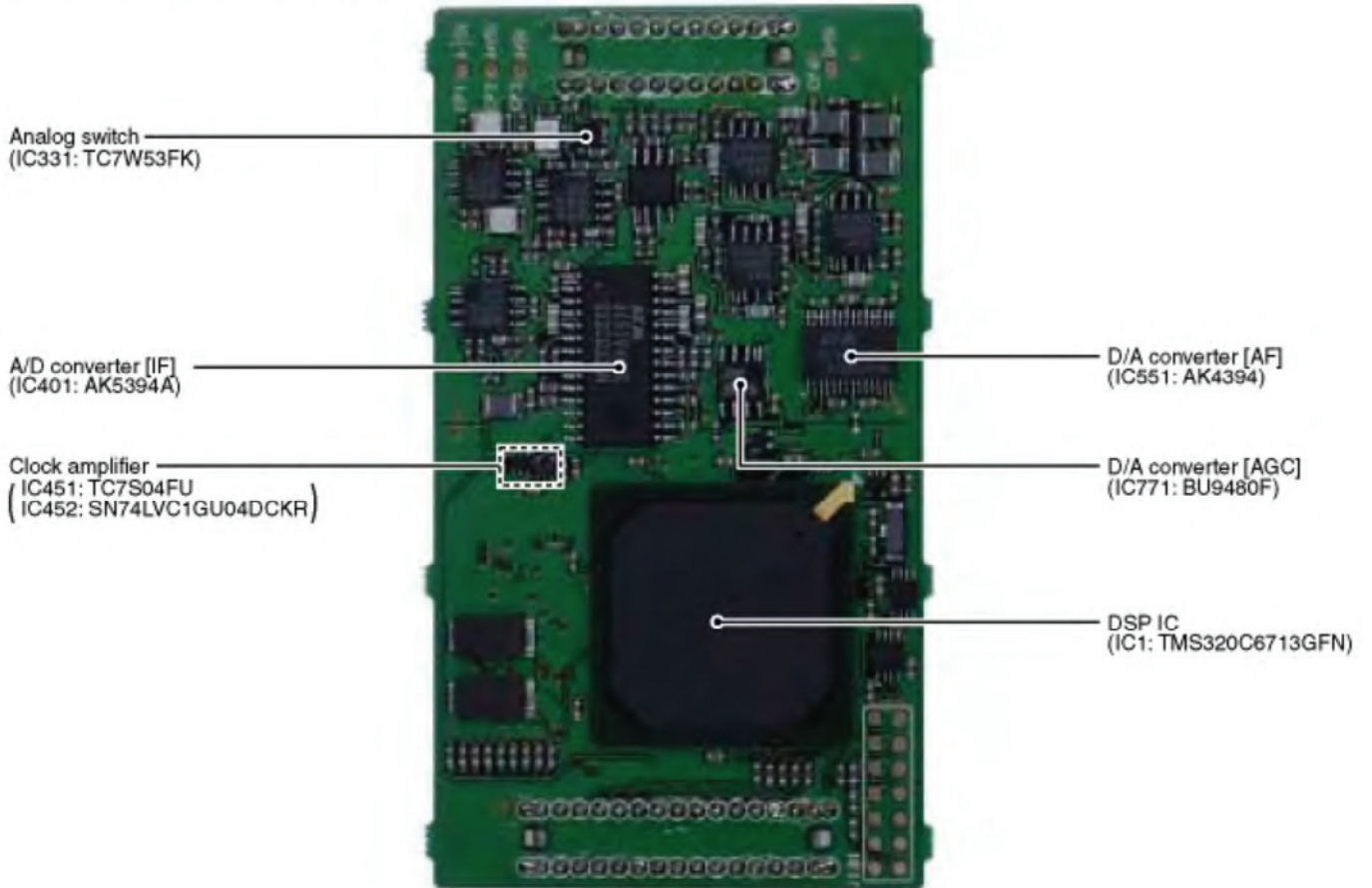

2-7 DSP-TX BOARD

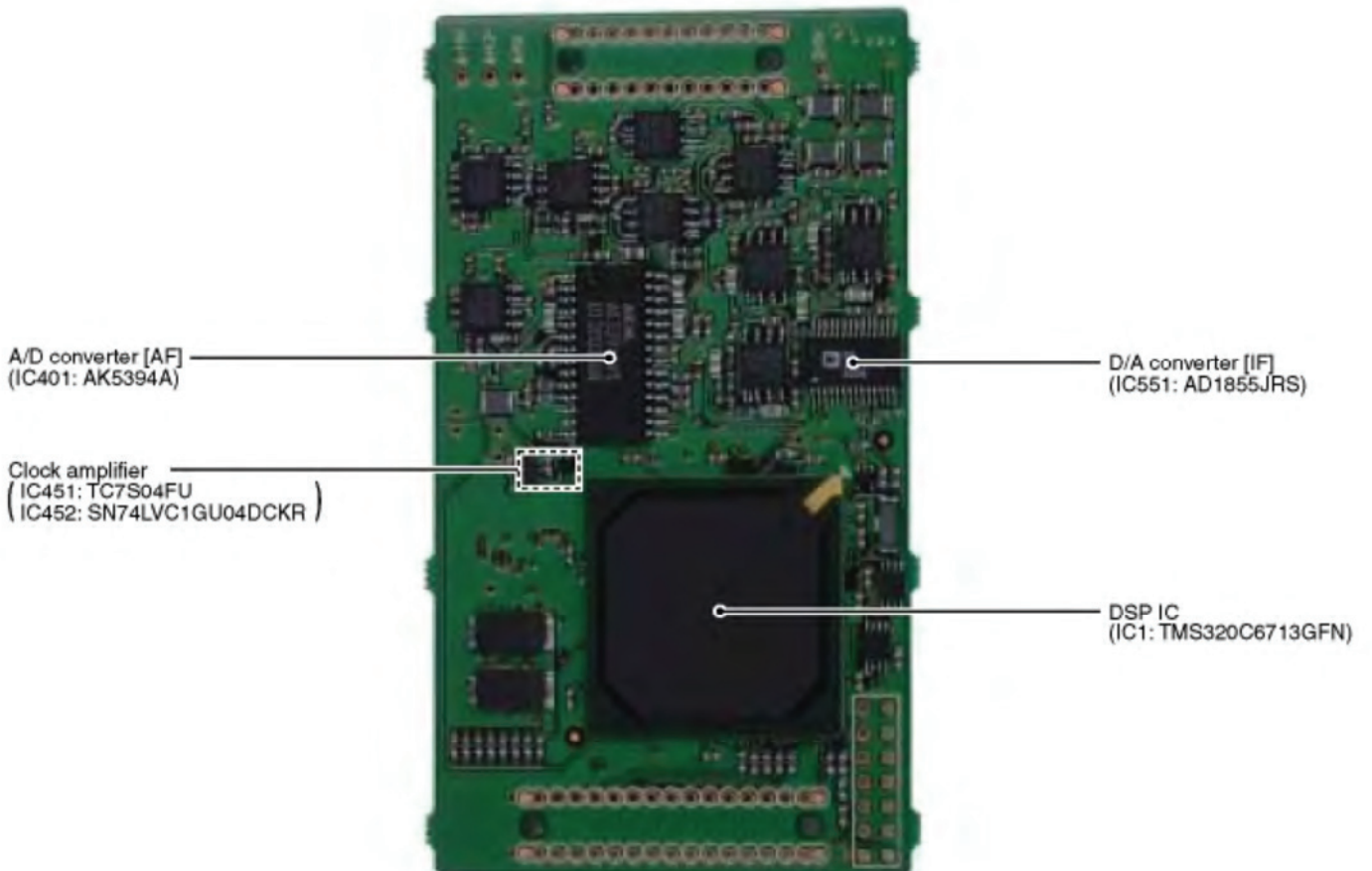

2-8 LOGIC UNIT

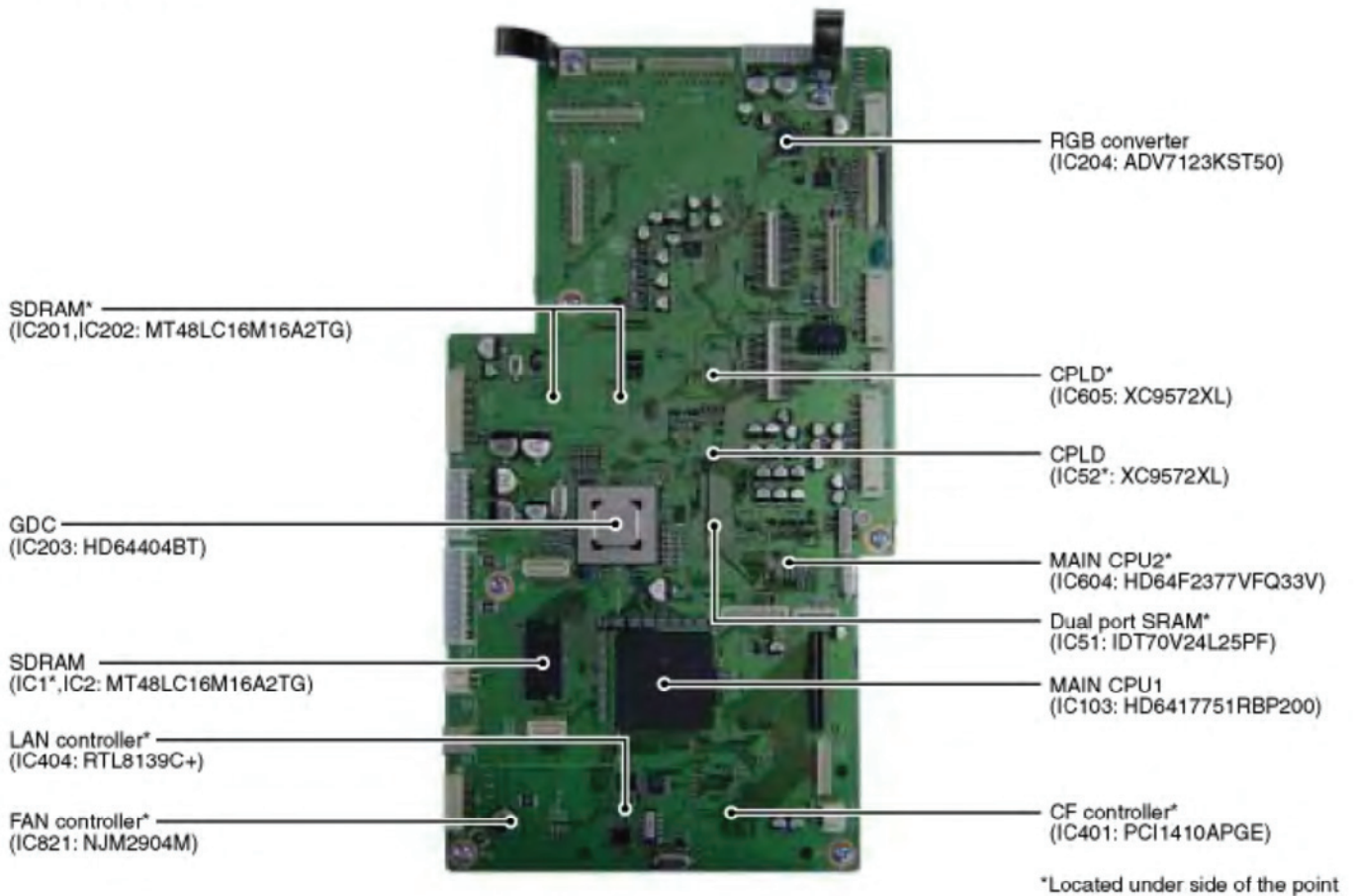

2-7 SCOPE UNIT

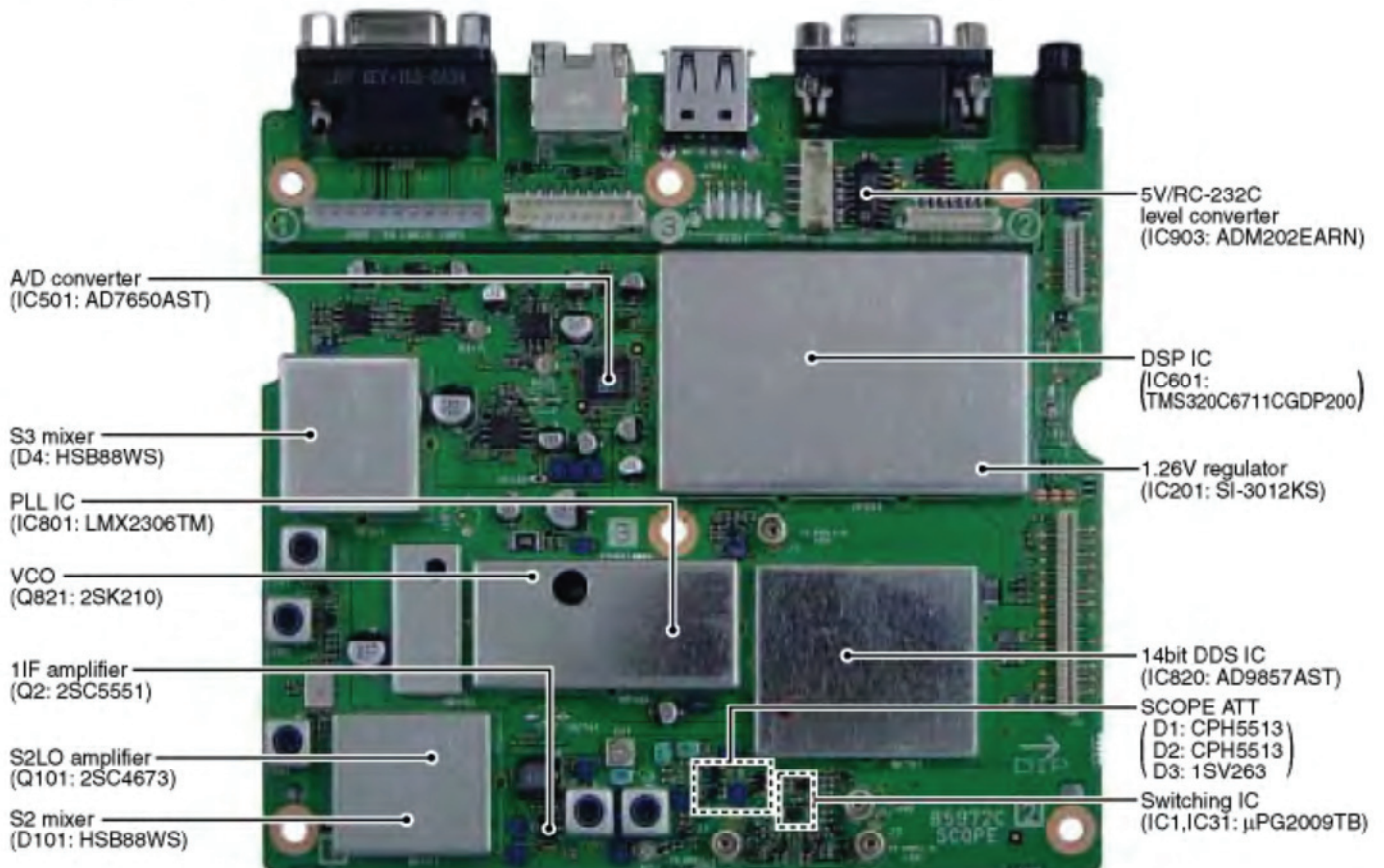

2-9 RXPLL-A BOARD

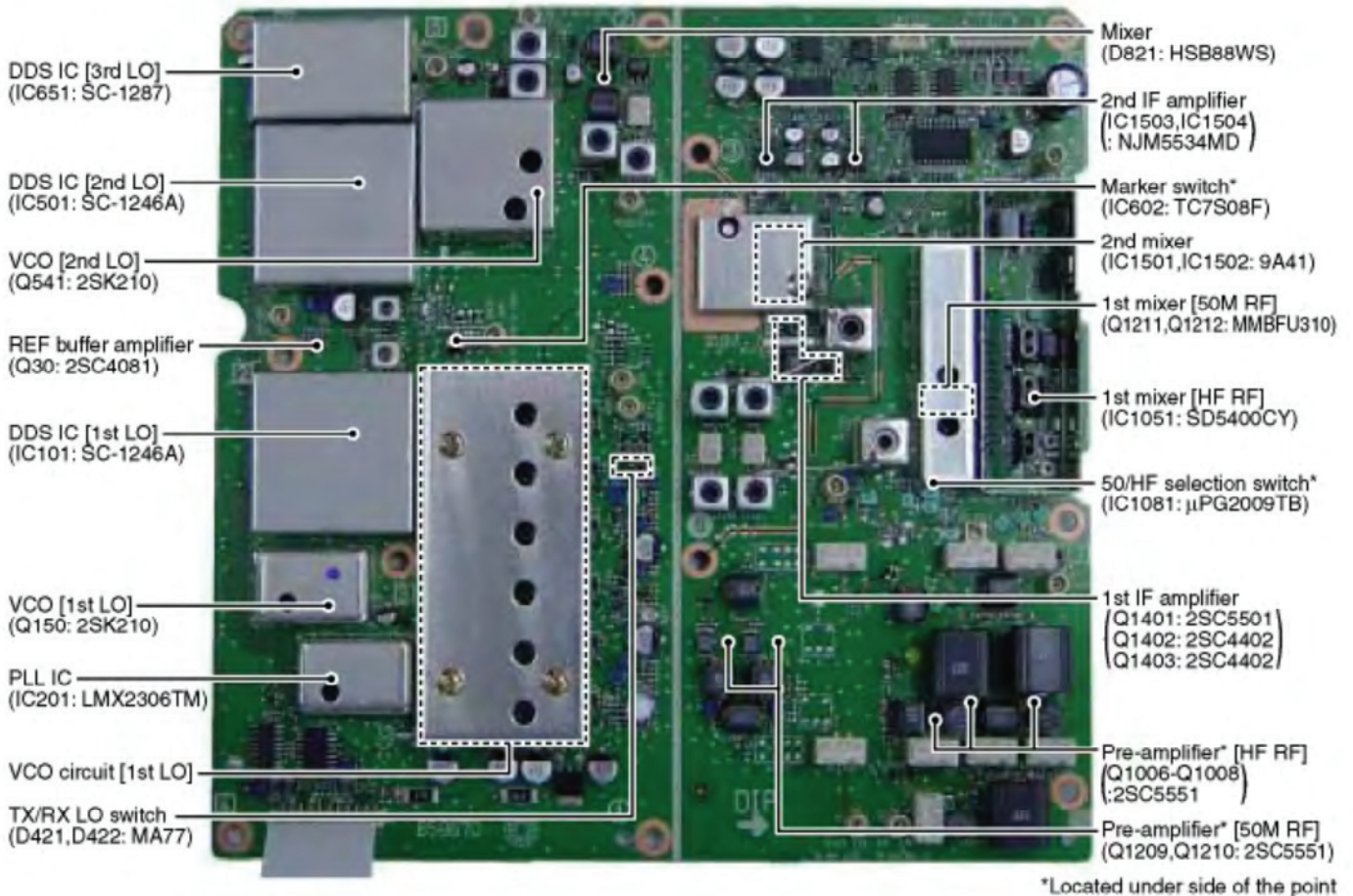

*Located under side of the point

2-10 RXPLL-B UNIT

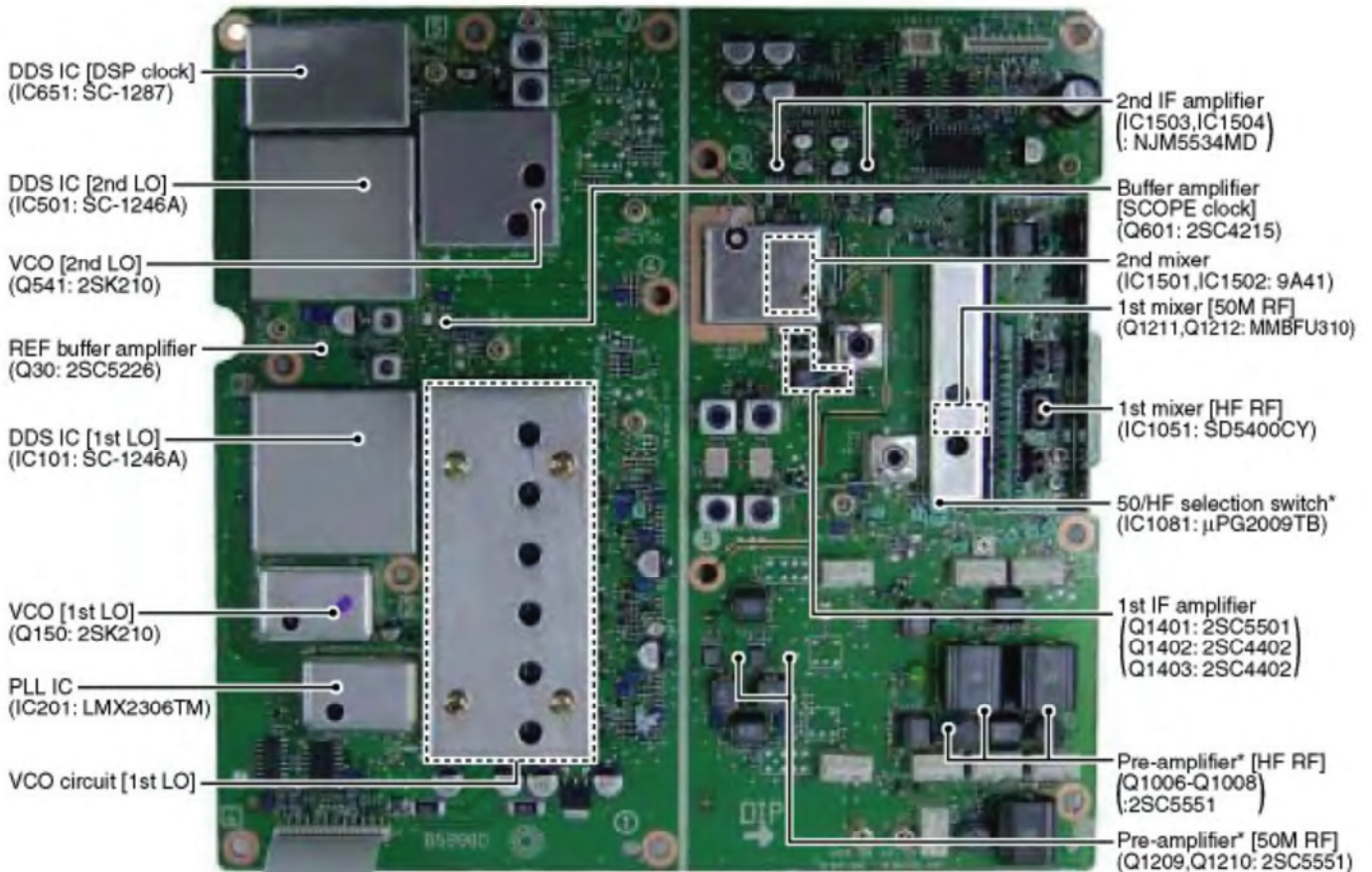

*Located under side of the point

2-11 OSC UNIT



2-12 PA200W BOARD

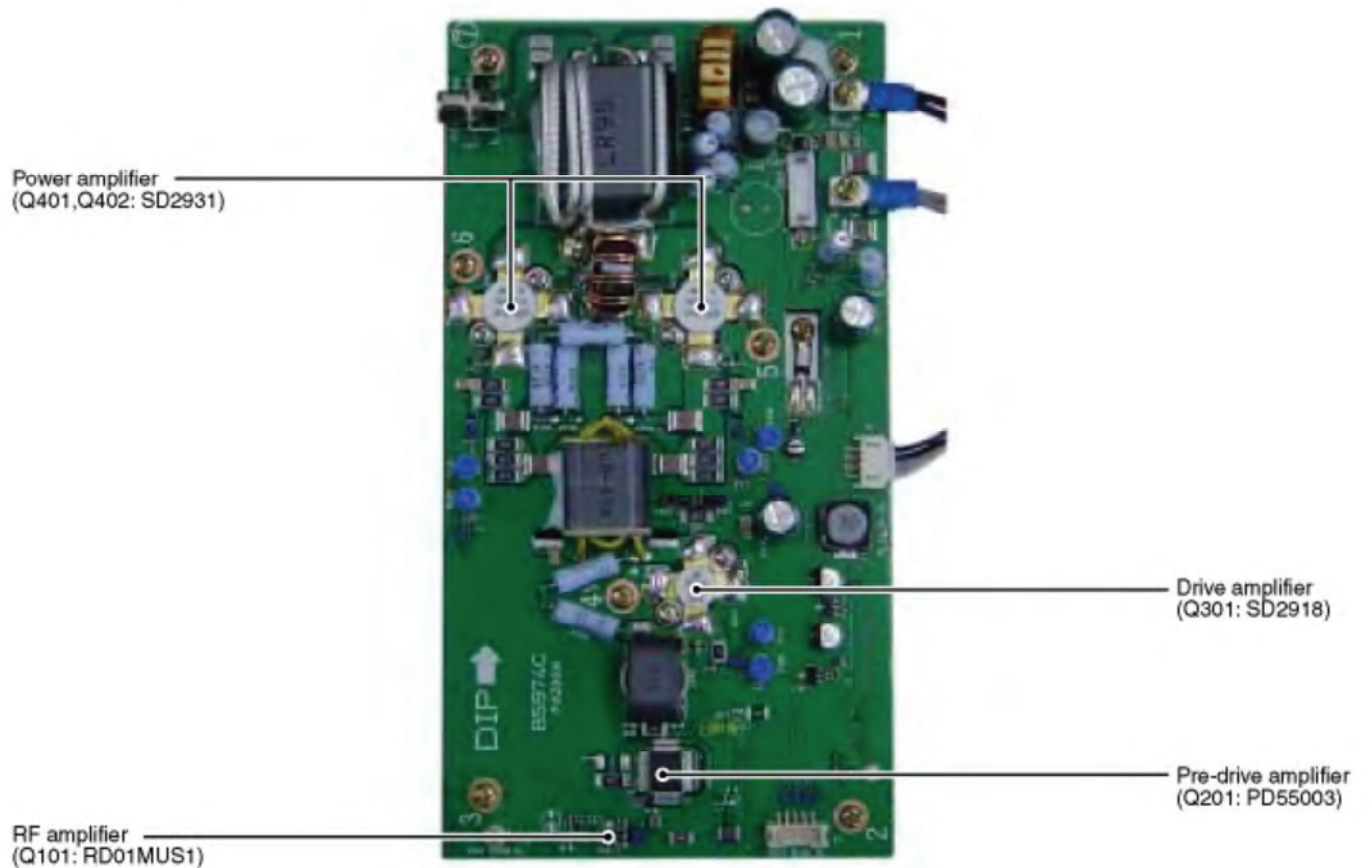

SECTION 3 CIRCUIT DESCRIPTION

3-1 RECEIVER CIRCUITS

3-1-1 ANTENNA SWITCHING CIRCUIT (ANT-SW UNIT)

The ANTENNA switching circuit leads receive signals to bandpass filters from an antenna connector while receiving. However, the circuit leads the signal from the RF power amplifier to the antenna connector while transmitting. RF signals are applied to the RX-A, RX-B or RX-ONLY circuits.

• RX-A CIRCUIT

RF signals from [ANT1], [ANT2], [ANT3] or [ANT4] pass through one of the antenna selectors (RL51; passing through [ANT1], RL61; passing through [ANT2], RL71; passing through [ANT3], RL81; passing through the ANT4), and are then applied to the CTRL board via J1.

The RF signals pass through the current detector (CTRL board; D301, D302), and are then applied to the BPF unit via J351 on the CTRL board.

• RX-B CIRCUIT

RF signals from [ANT1], [ANT2], [ANT3] or [ANT4] pass through one of the antenna selectors (RL52; passing through [ANT1], RL62; passing through [ANT2], RL72; passing through [ANT3], RL82; passing through the ANT4), and are then applied to the BPF unit via J2.

• RX-ONLY CIRCUIT

RF signals from [ANT4] pass through the antenna selector (RL84), and are then applied to the BPF unit via J3.

3-1-2 BANDPASS FILTER CIRCUIT (BPF, DIGISEL-A AND DIGISEL-B UNITS)

RF bandpass filters pass only the desired band signals and suppress any undesired band signals. The RF circuit has 11 bandpass filters and 1 low-pass filter.

• RX-A OR RX-ONLY CIRCUITS

RF signals from RX-A circuit (CTRL board; J1) or RX-ONLY circuit (ANT-SW unit; J3) are applied to the RF signal switching circuit (RL402) via the REV_Po detector (Q401, D402). The filtered signals pass through (or bypass) splitter (L371–L373) via the RL371 and RL355, and are then attenuated at RL354 (3 dB), RL353 (6 dB) and RL352 (12 dB). A portion of the filtered signals are separated at the splitter, and are then applied to the RX-B circuit's DW selector (RL855).

The attenuated signals pass through the low-pass filter or one of the bandpass filters.

(1) 0.03–30 MHz (BPF BOARD AND DIGISEL-A UNIT)

The signals pass through the low-pass filter or one of the 9 bandpass filters. The filtered signals pass through (or bypass) the bandpass filter and the RF amplifier (DIGISEL-A unit; Q201) via the D S THRU selector (RL21 and RL2) on the DIGISEL-A unit, and are then applied to the pre-amplifier circuit on the RXPLL-A unit.

(2) 50–60 MHz (BPF BOARD)

The signals pass through the one of the 2 bandpass filters, and are then amplified (or bypass) at the DW amplifier (Q901) via the DW selector (RL900, RL901). The signals are applied to (or bypass) the pre-amplifier circuit.

• RX-B CIRCUIT

RF signals from RX-B circuit (ANT-SW unit; J2) pass through the REV_Po detector (Q873, D872). The signals are applied to the DW selector (RL855). A portion of RF signals from RX-A or RX-ONLY circuits are applied to the this selector too.

The signals are attenuated at RL854 (3 dB), RL853 (6 dB) and RL852 (12 dB), and are then applied to the 6M selector (RL851).

The attenuated signals pass through the low-pass filter or one of the bandpass filters.

(1) 0.03–30 MHz (BPF BOARD AND DIGISEL-B UNIT)

The signals pass through the low-pass filter or one of the 9 bandpass filters. The filtered signals pass through (or bypass) the bandpass filter and the RF amplifier (DIGISEL-B unit; Q701) via the D_S_THRU selector (RL521 and RL502) on the DIGISEL-B unit, and are then applied to the pre-amplifier circuit on the RXPLL-B unit.

(2) 50–60 MHz (BPF BOARD)

The signals pass through the one of the 2 bandpass filter, and are then amplified (or bypass) at the DW amplifier (Q951) via the DW selector (RL950, RL951). The signals are applied to (or bypass) the pre-amplifier circuit.

3-1-3 PRE-AMPLIFIER CIRCUITS (BPF UNIT, DIGISEL-A, RXPLL-A, DIGISEL-B AND RXPLL-B UNITS)

The IC-7800 has 2 gain levels of pre-amplifier circuits which is composed of the pre-amplifier1 and pre-amplifier2. The circuit is controlled by the [P.AMP] switch.

• RX-A OR RX-ONLY CIRCUITS

(1) 0.03–30 MHz (DIGISEL-A AND RXPLL-A UNIT)

The RF signals from the DIGISEL-A unit are applied to (or bypass) the DW amplifier (Q1001) via the DW selector (RL1001, RL1002), and are then applied to the pre-amplifier circuit.

When the [P.AMP] switch is set to [P.AMP 1] or [P.AMP 2], the signals are applied to the pre-amplifier1 (Q1007, Q1008) or pre-amplifier2 (Q1006) circuit via the P.AMP_ON selector (RL1003, RL1006) and P.AMP selector (RL1004, RL1005), respectively. Pre-amplified or bypassed signals are applied to the 1st mixer circuit after being passed through the low-pass filter (L1051–L1054, C1053–C1059, C1067).

(2) 50–60 MHz (BPF UNIT AND RXPLL-A UNIT)

When the [P.AMP] switch is set to [P.AMP 1] or [P.AMP 2], the amplified signals from the DW amplifier (BPF unit; Q901) are applied to the pre-amplifier2 (BPF unit; Q903) or pre-amplifier1 (RXPLL-A unit; Q1209, Q1210) via the P.AMP2_ON selector (BPF unit; RL902, RL903) and P.AMP1_ON selector (RXPLL-A unit; RL1203, RL1206), respectively. Pre-amplified or bypassed signals are applied to the 1st mixer circuit after being passed through the low-pass filter (RXPLL-A unit; L1217–L1219, C1244–C1250).

• RX-B CIRCUIT

(1) 0.03–30 MHz (DIGISEL-B AND RXPLL-B UNIT)

The RF signals from the DIGISEL-B unit are applied to (or bypass) the DW amplifier (Q1001) via the DW selector (RL1001, RL1002), and are then applied to the pre-amplifier circuit.

When the [P.AMP] switch is set to [P.AMP 1] or [P.AMP 2], the signals are applied to the pre-amplifier1 (Q1007, Q1008) or pre-amplifier2 (Q1006) circuit via the P.AMP_ON selector (RL1003, RL1006) and P.AMP selector (RL1004, RL1005), respectively. Pre-amplified or bypassed signals are applied to the 1st mixer circuit after being passed through the low-pass filter (L1052–L1054, C1053–C1059, C1067).

(2) 50–60 MHz (BPF BOARD AND RXPLL-B UNIT)

When the [P.AMP] switch is set to [P.AMP 1] or [P.AMP 2], the amplified signals from the DW amplifier (BPF unit; Q951) are applied to the pre-amplifier2 (BPF unit; Q953) or pre-amplifier1 (RXPLL-B unit; Q1209, Q1210) via the P.AMP2_ON selector (BPF unit; RL952, RL953) and P.AMP1_ON selector (RXPLL-B unit; RL1203, RL1206), respectively. Pre-amplified or bypassed signals are applied to the 1st mixer circuit after being passed through the low-pass filter (RXPLL-B unit; L1217–L1219, C1244–C1250).

• RX-A OR RX-ONLY CIRCUITS (RXPLL-A UNIT)

(1) 0.03–30 MHz

The signals from the pre-amplifier circuit pass through the L1055, and are then applied to the 1st mixer circuit (IC1051). The applied signals are mixed with 1st LO signal from the RXPLL-A circuit to convert from RF signals to a 64.455 MHz 1st IF signal.

The 1st IF signal passes through the low-pass filter (L1058–L1060, L1062, C1061–C1064, C1066, R1054), and is then applied to the 1st IF circuit.

(2) 50–60 MHz

The signals from the pre-amplifier circuit pass through the L1220, and are then applied to the 1st mixer circuit (Q1211, Q1212). The applied signals are mixed with 1st LO signal from the RXPLL-A circuit to convert from RF signals to a fixed 64.455 MHz 1st IF signal.

The 1st IF signal is applied to the 1st IF circuit.

• RX-B CIRCUIT (RXPLL-B UNIT)

(1) 0.03–30 MHz

The signals from the pre-amplifier circuit pass through the L1055, and are then applied to the 1st mixer circuit (IC1051). The applied signals are mixed with 1st LO signal from the RXPLL-B circuit to convert from RF signals to a fixed 64.555 MHz 1st IF signal.

The 1st IF signal is applied to the 1st IF circuit.

(2) 50–60 MHz

The signals from the pre-amplifier circuit pass through the L1220, and are then applied to the 1st mixer circuit (Q1211, Q1212). The applied signals are mixed with 1st LO signal from the RXPLL-B circuit to convert from RF signals to a fixed 64.555 MHz 1st IF signal.

The 1st IF signal is applied to the 1st IF circuit.

3-1-4 1ST MIXER CIRCUIT (RXPLL-A AND RXPLL-B UNITS)

The 1st mixer circuit mixes the receive signals with the 1st LO signal to convert the receive signal frequencies into a 64.455 MHz (main) or 64.555 MHz (sub) 1st IF signal. The IC-7800 has four 1st mixer circuits for the dualwatch function.

• RECEIVER CONSTRUCTION

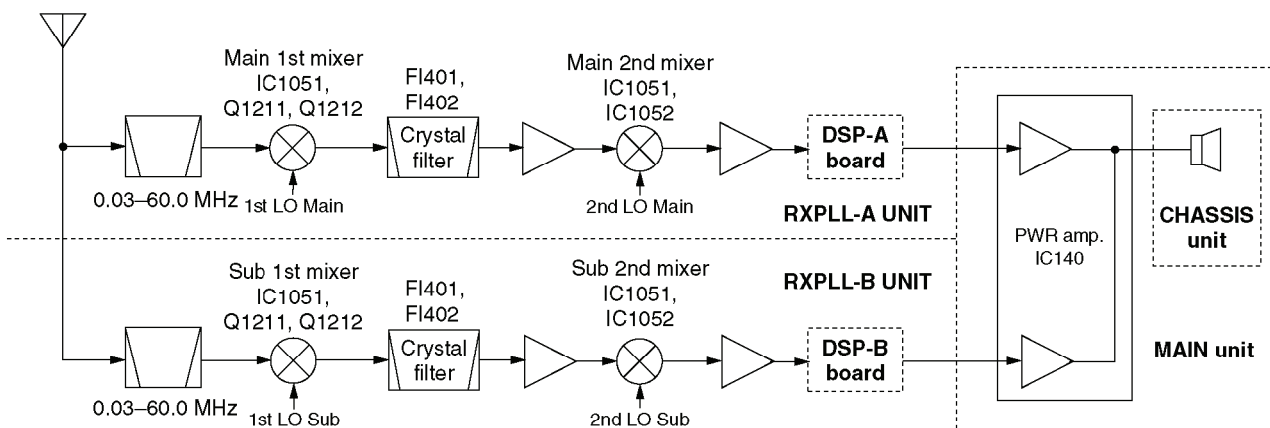

3-1-5 1ST IF CIRCUIT (RXPLL-A AND RXPLL-B UNITS)

The 1st IF circuit filters and amplifies the 1st IF signal. The 1st IF signal selected at 50/HF selector is applied to an MCF (Monolithic Crystal Filter) to suppress out-of-band signals.

• RX-A OR RX-ONLY CIRCUITS (RXPLL-A UNIT)

The filtered 1st IF signals from the HF band 1st mixer and 50 MHz band 1st mixer are applied to the 50/HF selector (IC1081, pin 3: for HF band / pin 1: for 50 MHz band) respectively. The signal from pin 5 of the 1st mixer passes through the one of the two crystal bandpass filters (F11401: bandwidth is 15 kHz, or F11402: bandwidth is 6 kHz) via the FIL selector (IC1402, IC1403). The filtered signal is amplified at the 1st IF amplifiers (Q1401–Q1403). The amplified 1st IF signal is applied to the 2nd mixer circuit.

• RX-B CIRCUIT (RXPLL-B UNIT)

The filtered 1st IF signals from the HF band 1st mixer and 50 MHz band 1st mixer are applied to the 50/HF selector (IC1081, pin 3: for HF band / pin 1: for 50 MHz band) respectively. The signal from pin 5 of the 1st mixer passes through the one of the two crystal bandpass filters (F11401: bandwidth is 15 kHz, or F11402: bandwidth is 6 kHz) via the FIL selector (IC1402, IC1403). The filtered signal is amplified at the 1st IF amplifiers (Q1401–Q1403), and is then applied to the 2nd mixer circuit.

3-1-6 2ND MIXER CIRCUIT (RXPLL-A AND RXPLL-B UNIT)

The 2nd mixer circuit mixes the amplified 1st IF signal and 2nd LO signal for conversion into the 2nd IF signal.

• RX-A OR RX-ONLY CIRCUITS (RXPLL-A UNIT)

The 1st IF signal from the 1st IF amplifier (Q1401–Q1403) is applied to the 2nd mixer circuit (IC1501, pin 4; IC1502, pin 4) respectively. The applied signals are mixed with 2nd LO signal from the RXPLL-A circuit to convert from 1st IF signal to 36 kHz 2nd IF signal.

The 2nd IF signal from the 2nd mixer circuit (IC1501, pin 5) is amplified at the buffer amplifier (Q1501), and is then applied to the 2nd IF amplifier (IC1503, pin 3). The signal is applied to the 90 degrees transphasor (IC1505, pin 6).

The 2nd IF signal from the other 2nd mixer circuit (IC1502, pin 5) is amplified at the buffer amplifier (Q1502), and is then applied to the 2nd IF amplifier (IC1504, pin 3). The signal is applied to the 90 degrees transphasor (IC1505, pin 2).

The signals from the 90 degrees transphasor (IC1505, pin 1 and 7) are applied to the compositor (IC1505, pins 9 and 10). The signals is amplified at other 2nd IF amplifier, and is then applied to the DSP-A unit to demodulate 2nd IF signal.

A portion of 2nd IF signal from the compositor (IC1505, pin 8) is applied to the AGC detector circuit.

The 2nd mixer circuit has 2 mixers and 90 degrees transphasor to improve image rejection ratio.

• RX-B CIRCUIT (RXPLL-B UNIT)

The 1st IF signal from the 1st IF amplifier (Q1401–Q1403) is applied to the 2nd mixer circuit (IC1501, pin 4; IC1502, pin 4) respectively. The applied signals are mixed with 2nd LO signal from the RX-B circuit to convert from 1st IF signal to 36 kHz 2nd IF signal.

The 2nd IF signal from the 2nd mixer circuit (IC1501, pin 5) is amplified at the buffer amplifier (Q1501), and is then applied to the 2nd IF amplifier (IC1503, pin 3). The signal is applied to the 90 degrees transphasor (IC1505, pin 6).

The 2nd IF signal from the other 2nd mixer circuit (IC1502, pin 5) is amplified at the buffer amplifier (Q1502), and is then applied to the 2nd IF amplifier (IC1504, pin 3). The signal is applied to the 90 degrees transphasor (IC1505, pin 2).

The signals from the 90 degrees transphasor (IC1505, pin 1 and 7) are applied to the compositor (IC1505, pins 9 and 10). The signals is amplified at other 2nd IF amplifier, and is then applied to the DSP-B unit to demodulate 2nd IF signal.

A portion of 2nd IF signal from the compositor (IC1505, pin 8) is applied to the AGC detector circuit.

The 2nd mixer circuit has 2 mixers and 90 degrees transphasor to improve image rejection ratio.

3-1-7 DSP RECEIVER CIRCUIT (DSP-A AND DSP-B UNITS)

The DSP (Digital Signal Processor) circuit enables digital IF filter, digital noise reduction, digital PSN (Phase Shift Network)/Low Power/Phase demodulation, digital automatic notch, etc.

• DSP CIRCUIT (RECEIVER)

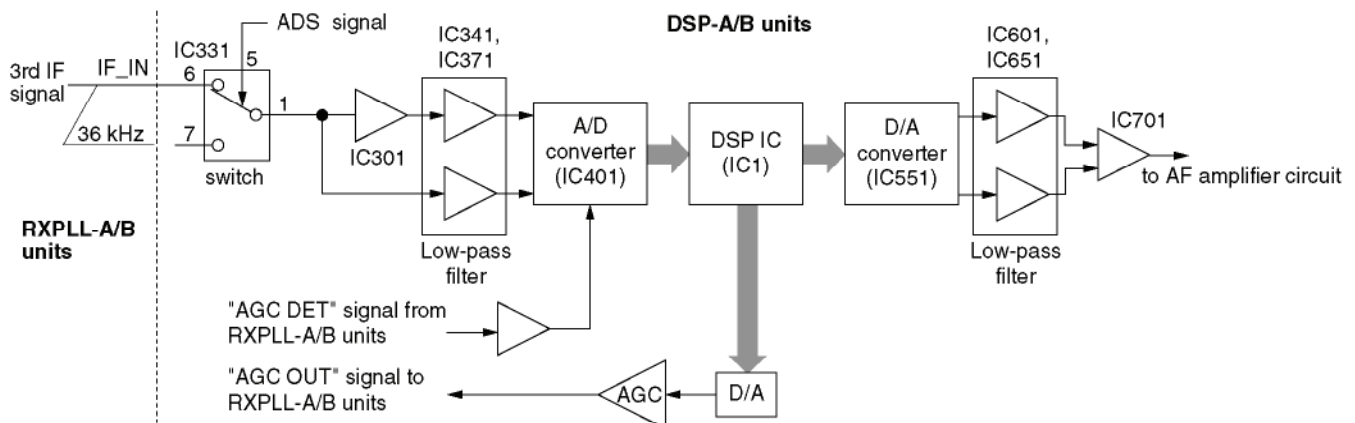

• RX-A AND RX-ONLY CIRCUITS (DSP-A UNIT)

The 36 kHz 2nd IF signal from the 2nd IF amplifier (RXPLL-A unit, IC1506) passes through the analog switch (IC331, pins 7, 1) with limiter function, and is then applied to the buffer amplifiers (IC301; pin 2, IC341; pin 2, IC371; pin 2) to convert to balancing signal. The signal is applied to the A/D convertor IC (IC401, pins 4, 5).

The digital signals are applied to the DSP IC (IC1) to do filtering, demodulate and so on. The demodulated digital signals are applied to the D/A convertor IC (IC551) to convert analog AF signals.

The signals pass through the low-pass filter (IC601, pins 3 and 6, IC651, pins 3 and 6), and are then applied to the buffer amplifier (IC701, pins 2 and 3) to convert to unbalancing signals.

The signals are applied to the AF amplifier circuit.

• RX-B CIRCUIT (DSP-B UNIT)

The 36 kHz 2nd IF signal from the 2nd IF amplifier (RXPLL-B unit, IC1506) passes through the analog switch (IC331, pins 7, 1) with limiter function, and is then applied to the buffer amplifiers (IC301; pin 2, IC341; pin 2, IC371; pin 2) to convert to balancing signal. The signal is applied to the A/D convertor IC (IC401, pins 4, 5).

The digital signals are applied to the DSP IC (IC1) to do filtering, demodulate and so on. The demodulated digital signals are applied to the D/A convertor IC (IC551) to convert analog AF signals.

The signals pass through the low-pass filter (IC601, pins 3 and 6, IC651, pins 3 and 6), and are then applied to the buffer amplifier (IC701, pins 2 and 3) to convert to unbalancing signals.

The signals are applied to the AF amplifier circuit.

3-1-8 AF AMPLIFIER CIRCUITS (MAIN UNIT)

The AF amplifier circuits amplifies the AF input signals to the suitable driving level for the speaker.

• MAIN SPEAKER OUTPUT

The AF signals from the DSP-A and DSP-B units are applied to the AF switch (MAIN unit: IC100, pin 7 for DSP-A, pin 6 for DSP-B), and pass through the SQL switch (Q100) which is controlled by "SQLM" signal. The signals are applied to the buffer amplifier (IC102, pin 3), and are then amplified at the VCA (Voltage Control Amplifier) circuit (IC105, pin 14). The amplified signals from VCA circuit from pin 11 are applied to the AF power amplifier (IC140, pin 1) to obtain the suitable driving level for speaker. The output signals from pin 13 pass through the mute switch (Q141, RL140), and are then applied to the internal speaker jack (J142, pin 1) via the MAIN speaker phone jack (J140).

• SUB SPEAKER OUTPUT

The AF signals from the DSP-A and DSP-B units are applied to the AF switch (MAIN unit: IC101, pin 6 for DSP-A, pin 7 for DSP-B), and pass through the SQL switch (Q101) which is controlled by "SQLS" signal. The signals are applied to the buffer amplifier (IC102, pin 5), and are then amplified at the VCA (Voltage Control Amplifier) circuit (IC105, pin 1). The amplified signals from VCA circuit from pin 4 are applied to the AF power amplifier (IC140, pin 2) to obtain the suitable driving level for speaker. The output signals from pin 12 pass through the mute switch (Q141, RL140), and are then applied to the SUB speaker jack (J141).

• AF AMPLIFIER CIRCUIT

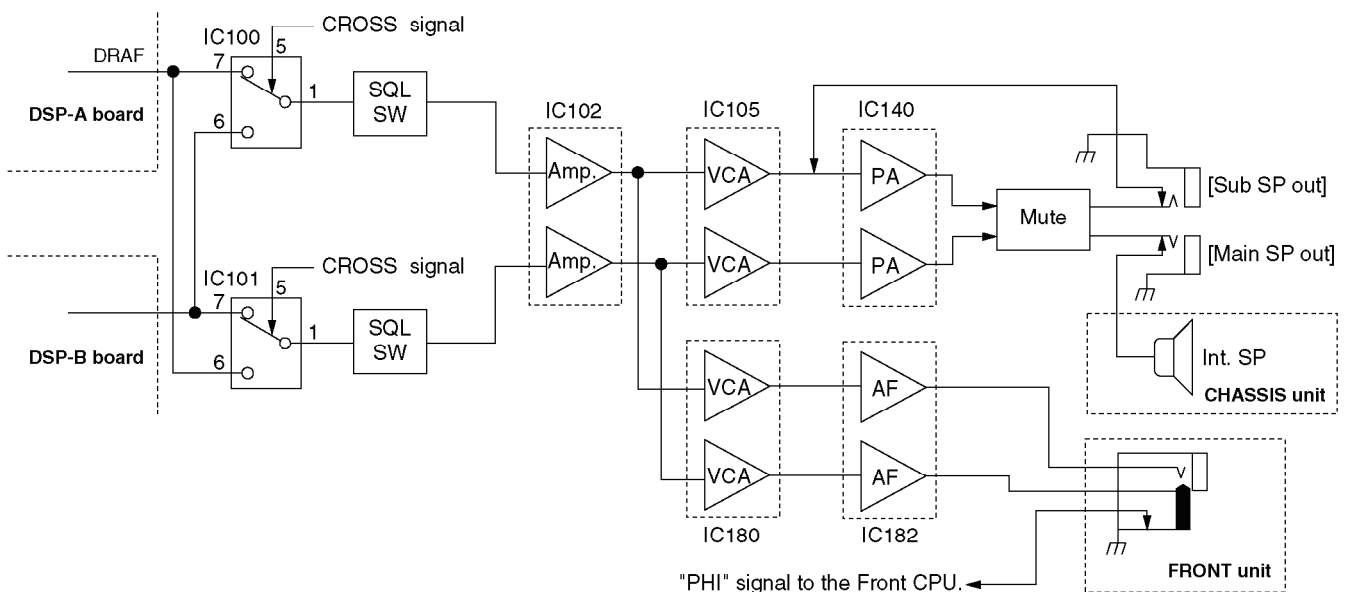

**3-1-9 AGC CIRCUIT
(RXPLL-A, DSP-A, RXPLL-B AND DSP-B UNITS)**

The AGC (Automatic Gain Control) circuit reduces IF amplifier gain and attenuates IF signal to keep the audio output at a constant level.

• RX-A CIRCUIT (RXPLL-A AND DSP-A UNITS)

A part of signals from the compositor circuit (RXPLL-A unit; IC1505, pin 8) are applied to the AGC detector circuit (IC1652, D1653), and are then amplified at the AGC amplifier (RXPLL-A unit; IC1653, pin 3). The amplified signals are applied to the DSP-A unit via the J921, pin 1 on the DSP-A unit as "AGCDET_A" line.

The signals are applied to the amplifier (DSP-A unit; IC501, pin 2), and are then applied to the A/D converter (DSP-A unit; IC401, pin 25). The converted digital signals are applied to the DSP IC (DSP-A unit; IC1), and then applied to the D/A converter (DSP-A unit; IC771). The converted analog signals are amplified at the AGC amplifier (DSP-A unit; IC501, pin 5), and are then applied to the MAIN unit via the J921, pin 6 as "AGCOUT_A" line.

The signals are applied to the RXPLL-A unit via the J1701, pin 9 as "DAGC" line after being passed through the J400, pin 8 on MAIN unit as "AGC1A" line. The signals are amplified at the AGC amplifier (RXPLL_A unit; IC1653, pin 5), and are then applied to the IF amplifier (RXPLL-A unit; Q1403) as AGC signal.

• RX-B CIRCUIT (RXPLL-B AND DSP-B UNITS)

A part of signals from the compositor circuit (RXPLL-B unit; IC1505, pin 8) are applied to the AGC detector circuit (IC1652, D1653), and are then amplified at the AGC amplifier (RXPLL-B unit; IC1653, pin 3). The amplified signals are applied to the DSP-B unit via the J921, pin 1 on the DSP-B unit as "AGCDET_B" line.

The signals are applied to the amplifier (DSP-B unit; IC501, pin 2), and are then applied to the A/D converter (DSP-B unit; IC401, pin 25). The converted digital signals are applied to the DSP IC (DSP-B unit; IC1), and then applied to the D/A converter (DSP-B unit; IC771). The converted analog signals are amplified at the AGC amplifier (DSP-B unit; IC501, pin 5), and are then applied to the MAIN unit via the J921, pin 6 as "AGCOUT_B" line.

The signals are applied to the RXPLL-B unit via the J1701, pin 9 as "DAGC" line after being passed through the J400, pin 8 on MAIN unit as "AGC1B" line. The signals are amplified at the AGC amplifier (RXPLL_B unit; IC1653, pin 5), and are then applied to the IF amplifier (RXPLL-B unit; Q1403) as AGC signal.

3-2 TRANSMITTER CIRCUITS

**3-2-1 MICROPHONE AMPLIFIER CIRCUIT
(MAIN-A UNIT)**

The microphone amplifier circuit amplifies microphone audio signals to a level needed for the DSP circuit.

Audio signals from the [MIC] connector (MIC board; J1, pin 1) are amplified at the audio amplifier section in IC821 (pin 2), then applied to the VCA section. The gain controlled signals are output from (IC821, pin 4) and passed through the analog switch (IC201, pins 1, 7). The signals pass through the analog switch (IC460, pins 6, 1), and are then applied to the DSP circuit after being passed through the limiter amplifier (IC230, pins 3, 1) as the "AFIN" signal.

The VCA section in IC821 controls microphone input gain according to the [MIC GAIN] control level using the MIGV signal coming from the main CPU via the I/O expander (IC330, pin 2).

**3-2-2 DSP TRANSMITTER CIRCUIT
(TX DSP UNIT)**

The DSP (Digital Signal Processor) circuit enables digital IF filter, digital noise reduction, digital PSN (Phase Shift Network)/Low Power/Phase demodulation, digital automatic notch, and etc.

The AF signals from the limiter amplifier (MAIN unit, IC230, pin 1) are then applied to the buffer amplifiers (IC301; pins 2, 6, IC341; pins 2, 6 IC371; pins 2, 6) to convert to balancing signal. The signal is applied to the A/D converter IC (IC401, pins 4, 5).

The digital signals are applied to the DSP IC (IC1) to do filtering, modulate and so on. The modulated signals are applied to the D/A converter IC (IC551) to convert 36 kHz IF signal.

• DSP TRANSMITTER CIRCUIT

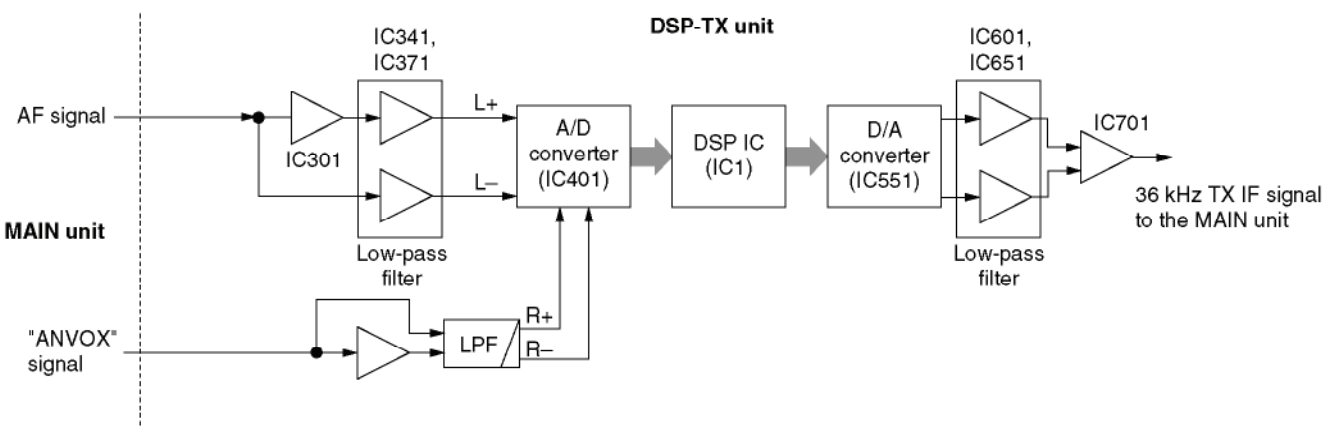

The signal passes through the low-pass filter (IC601, pins 3 and 6, IC651, pins 3 and 6), and is then applied to the IF amplifier (IC701, pins 2 and 3) to convert to unbalancing IF signal.

The 36 kHz IF signal from the IF amplifier (pin 6) is applied to the 3rd mixer circuit.

3-2-3 3RD MIXER CIRCUIT (MAIN UNIT)

The modulated 36 kHz IF signal from the TX DSP unit pass through the two low-pass filters (IC501, pins 3, 6; IC502, pins 3, 6), and is then applied to the 3rd mixer circuit (IC503, pin 3). The 36 kHz IF signal is mixed with 491 kHz 3rd LO signal (from RXPLL-A unit) to produce the 455 kHz 3rd IF signal.

The signal is amplified at the IF amplifier (Q501), and passes through the ceramic bandpass filter (FI501; 20 kHz, FI502; 4 kHz). The filtered signal is amplified at the other IF amplifier (Q504), and is then applied to the 2nd mixer circuit via the attenuator (R545–R547).

3-2-4 2ND MIXER CIRCUIT (MAIN UNIT)

The 3rd IF signal from the 3rd mixer circuit is applied to the 2nd mixer circuit (D505). The 3rd IF signal is mixed with 64 MHz 2nd LO signal (from RXPLL-A unit) to produce the 2nd IF signal.

The signal passes through the bandpass filter (FI503; $F_c=64.455$ MHz) to suppress unwanted signals, and is then applied to the IF amplifier (Q506). The 2nd IF signal is applied to the 1st mixer circuit.

3-2-5 1ST MIXER AND RF CIRCUITS (MAIN UNIT)

The 2nd IF signal from the 2nd mixer circuit is applied to the 1st mixer circuit (D506). The 1st IF signal is mixed with 1st LO signal (from the RXPLL-A unit) to produce the RF signal. The RF signal passes through the low-pass filter (L518, L519, C564–C568) and 3 dB attenuator (R578–R580). The signal is then applied to the RF amplifier and bandpass filter circuits.

3-2-5 RF AMPLIFIER AND BANDPASS FILTER CIRCUITS (MAIN UNIT)

The RF signal is amplified at the RF amplifier (Q508), and applied to the one of the 10 bandpass filters via the 5 dB attenuator (R575–R577).

The filtered signal is applied to the YGR amplifier (Q801), and passes through the 3 dB attenuator (R805–R807). The signal is applied to the power amplifier circuit via the J801.

3-2-6 POWER AMPLIFIER CIRCUIT (PA200W UNIT)

The signal from the attenuator (MAIN unit; R805–R807) passes through the 3 dB attenuator (R101–R103) via the J1, and is then amplified at the RF amplifier (Q101). The signal is applied to the pre-drive (Q201) and drive amplifier (Q301), and is then amplified at the power amplifier (Q401, Q402) to obtain 200 W output power.

The output signal is applied to the FILTER circuit via the J401.

3-2-7 FILTER CIRCUIT (FILTER UNIT)

The power amplified signal passes through the one of the 9 low-pass filters which is depended on the RF frequencies to suppress the unwanted frequency components. The filtered signal is applied to the CONTROL circuit via the J904.

3-2-8 CONTROL CIRCUIT (CTRL UNIT)

The signal from the FILTER unit is applied to the SWR-DET circuit (D101, D102) to detect SWR value, and then passes through the P-DET (D151, D152) and R-DET circuit (D201, D202). The signal is applied to the T/R switch (RL251), and is then applied to (or bypass) the antenna tuner circuit (NET-WORK board) via the antenna tuner selector switch (RL252, RL253).

The tuned signal from J252 (or bypass signal) passes through the CRNT DET circuit (D301, D302) to detect the driving current, and is then applied to the antenna switching circuit.

The detected signal at CRNT DET circuit is amplified at the amplifier (IC301, pin 3), and is then applied to the TUNER_CPU (IC1, pin 16).

3-2-9 ANTENNA SWITCHING CIRCUIT (ANT-SW UNIT)

The signal from the CTRL unit is applied to the ANT-SW unit via the J1, and is applied to the one of the 4 relays (RL51, RL61, RL71, RL81). The signal is output from the one of the 4 antenna connectors, J51, J61, J71 or J81.

• TRANSMITTER CONSTRUCTION

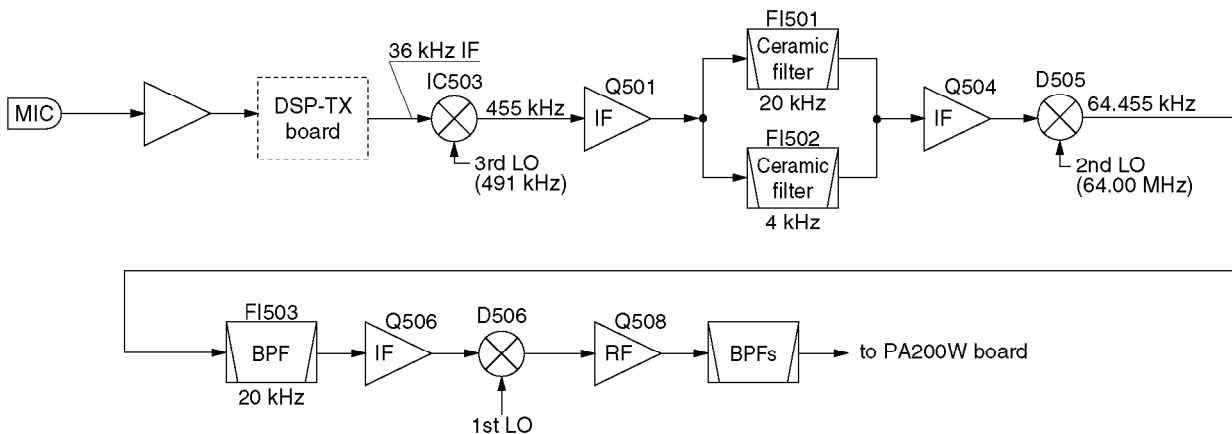

The antenna switching relays are controlled by the RL-CTRL CPU (IC11, pins 6, 9, 12, 15) as the “ANT1A”, “ANT2A”, “ANT3A” and “ANT4A” signals respectively.

3-2-10 ALC CIRCUIT (CTRL BOARD, LOGIC AND MAIN UNITS)

The RF power level is detected at one of the SWR detector circuits (CTRL unit; D102) to be converted into DC voltage and applied to the MAIN-A unit as the FORV signal via the LOGIC unit.

The FORV signal from the LOGIC unit is applied to the comparator (MAIN unit; IC60, pin 2). The POCV signal, controlled by the [RF POWER] control via the I/O expander (MAIN unit; IC330, pin 4), is also applied to the other input (pin 3) for reference. The compared signal is output from pin 1 and applied to the IF amplifiers (MAIN unit; Q504 and Q506) to control amplifying gain.

When the FORV signal exceeds the POCV voltage, ALC bias voltage from the comparator controls the IF amplifiers. This adjusts the output power to a specified level from the [RF POWER] control until the FORV and POCV voltages are equalized.

In AM mode, the comparator operates as an averaging ALC amplifier. Q61 (MAIN unit) turns ON and the POCV voltage is shifted for 50 W AM output power (maximum) through R82.

The ALC bias voltage is also applied to the ALC meter amplifier (MAIN unit; IC61, pin 9) to obtain an ALC meter signal (ALCL). The amplified signal is applied to the main CPU2 (LOGIC unit; IC604, pin 115) to drive the S/RF meter via the front CPU (IC6) on the DISPLAY board.

An external ALC input from the [ALC] jack, [ACC1] or [ACC2] sockets is applied to the ALC amplifier (Q62). External ALC operation is identical to that of the internal ALC.

The FORV signal is also applied to the power meter amplifier (LOGIC unit; IC851, pin 5). The amplified signal is applied to the main CPU2 (LOGIC unit; IC604, pin 113) to drive the S/RF meter as an FORL signal when the power meter is selected.

3-2-11 APC CIRCUIT (MAIN UNIT, CTRL AND PA200W BOARDS)

The APC (Automatic Power Control) circuit protects the power amplifiers on the PA 200W unit from high SWR and excessive current.

The reflected wave signal appears and increases when the connected antenna is mismatched to 50 Ω. The SWR detector (CTRL unit; D101) detects the reflected signal, and applies it to the APC circuit (MAIN unit; IC60, pin 13) as a REFV signal via the LOGIC unit.

When the REFV signal level increases, the APC circuit decreases the ALC voltage to activate the APC.

For the current APC, the power transistor current is obtained by detecting the voltages (IDH and IDL) which appear at both terminals of the ID detector (PA200W board; R505). The detected voltages are applied to the differential amplifier (IC60, pins 5, 6). When the current of transistors is increased, the amplifier controls the ALC line to prevent excessive current flow.

3-2-12 TEMPERATURE PROTECTION CIRCUIT (PA200W BOARD)

The cooling fan (CHASSIS; MF1) is activated while transmitting or when the temperature of the power amplifier exceeds the preset value. The temperature protection circuit consists of IC604, IC330, IC821, Q821, Q822 and R3.

While transmitting, IC821 and Q821 are turned ON, and provide a voltage to the cooling fan to rotate at medium speed. The thermistor (R3) detects the temperature of the power amplifier (Q401 and Q402). The detected signal is applied to the CPU (IC604, pin 118) to analyze the power amplifier's temperature via “THML” signal. The signal is applied to the D/A converter (IC330), and is then applied to the FAN controller (IC821, pin 1; Q821 and Q822) via “FANI” signal. The control signal outputs from the controller (IC821, pin 7) as “FANV” signal, and then controls cooling fan via the J824.

3-3 PLL CIRCUITS

3-3-1 GENERAL

The PLL circuits consist of OSC, RXPLL-A and RXPLL-B units.

The REF unit oscillates 10 MHz reference frequency for RXPLL-A, RXPLL-B units and external reference frequency.

The RXPLL-A unit oscillates 6 LO frequencies for the RX-A unit's receive 1st and 2nd LO frequencies, MAIN unit's transmit 1st, 2nd and 3rd LO frequencies, marker frequency.

The RXPLL-B unit oscillates 6 LO frequencies for the RX-B unit's receive 1st and 2nd LO frequencies, SCOPE unit's reference frequency, clock signal of DSP-TX, DSP-A and DSP-B unit.

1st and 2nd LO frequency lists for RX, 3rd IF and LO frequency lists and 2nd IF and LO frequency list are shown at page 3-14.

1st IF and 1st LO frequency lists for TX are shown at page 3-15.

3-3-2 OSCILLATOR CIRCUIT (OSC UNIT)

The reference oscillator (IC91, X1) generates a 10 MHz frequency which field intensity is 0 dBm. The signal is used for the RXPLL-A and RXPLL-B unit's system clock, etc.

• IN CASE OF USING AS RXPLL-A AND RXPLL-B UNIT'S SYSTEM CLOCK

The oscillated signal is amplified at the buffer amplifier (Q21), and is applied to the amplifier (Q22). The amplified signal passes through the oscillated signal selector (RL11), and is then amplified at the buffer amplifier (Q70). The amplified signal is applied to the RXPLL-A and RXPLL-B units via the J72 and J73, respectively.

• IN CASE OF USING REFERENCE SIGNAL TO EXTERNAL

The oscillated signal is amplified at the buffer amplifier (Q21), and is then applied to the amplifier (Q42). The amplified signal is applied to the input-output switching circuit (RL10) via the low-pass filter (L43, L44, C46–C51), and is then output from J71 after being passed through the 6 dB attenuator (R71–R73).

• IN CASE OF USING REFERENCE SIGNAL FROM EXTERNAL

The reference signal from external equipment is applied to the J71, and is then applied to the input-output switching circuit (RL10) via the 6 dB attenuator (R71–R73). The signal is applied to the amplifier (Q61, Q62), and passes through the bandpass filter (L61, L62, C66). The filtered signal is applied to the reference signal switching circuit (RL11), and is then amplified at the buffer amplifier (Q70). The amplified signal is applied to the RXPLL-A and RXPLL-B units via the J72 and J73, respectively.

3-3-3 RXPLL-A CIRCUIT

The 10 MHz oscillated signal from the OSC unit is applied to the amplifier (Q30) via the J10, and is then amplified at the quadrupler (Q702) to produce 40 MHz reference signal. The amplified signal passes through the bandpass filter (L702, L703, C709–C713), and is then applied to the 1st LO, maker, 2nd LO and 3rd LO circuits, respectively.

• 1ST LO CIRCUIT

The 40 MHz reference signal is applied to the amplifier (Q104) via the “40M” line, and is then applied to the DDS IC (IC101, pin 88) as the system clock signal.

The signal passes through the D/A convertor (R110–R133). The signal passes through the ceramic filter (F1101) to pass the 10.5 MHz signal, and is then applied to the amplifier (IC102, pin 2). The signal is applied to the DDS IC (IC101, pin 47) again, and is then applied to the phase detector section of the DDS IC. The signal which outputs from the DDS IC (IC101, pin 56) passes through the loop filter (L151, C152–C155), and is then applied to the oscillator circuit (Q150). The circuit oscillates 10.4122038–10.4963312 MHz signal.

The oscillated signal is applied to the amplifier (Q151), and is then applied to the PLL IC.

A part of the oscillated signal is fed back to the DDS IC (IC101, pin 46) via the amplifier (Q152) as the comparison signal.

The amplified signal from Q151 is applied to the PLL IC’s 1/21 divider section (IC201, pin 8), and is then applied to the PLL section. The signal outputs from pin 2, and passes through the loop filter (Q202). The filtered signal is applied to the one of the 6 VCOs as follow.

VCO No.	Parts No.	Display frequency
1	Q220	64.485–72.454999 MHz
2	Q230	72.455–79.454999 MHz
3	Q240	79.455–86.454999 MHz
4	Q250	86.455–94.454999 MHz
5	Q260	94.455–109.454999 MHz
6	Q270	109.455–124.455 MHz

The oscillated signal is amplified at the buffer amplifier (Q301), and passes through the low-pass (L331, C331–C333) and high-pass (D341, L332, C334–C337) filters. The signal is applied to the amplifier (Q302).

A portion of buffer amplified signal from Q301 is fed back to the PLL IC’s 1/N (N=130–250) divider section (IC201, pin 6).

The amplified signal from Q302 is applied to another amplifier (Q351), and is then amplified at the buffer amplifier (Q352). The signal passes through the low-pass filter (D441, L441, L442, C442–C446) and attenuator (R364–R366), and is then output from J351/J421 as the RX 1st LO signal (64.485–124.455 MHz)/TX 1st LO signal (64.485–124.455 MHz) to the RX-A/RX-B circuits respectively via the LO switching circuit (D421, D422).

• MARKER CIRCUIT

The 40 MHz reference signal is applied to the amplifier (Q104) via the “40M” line, and is then applied to the DDS IC (IC101, pin 88) as the system clock signal.

The signal passes through the DDS IC’s 1/400 divider section, and outputs from the IC (pin 49). The signal is applied to the marker switch (IC602, pin 1), and is then output from the IC (pin 4) as the 100 kHz marker signal.

• 2ND LO CIRCUIT

The 40 MHz reference signal is applied to the amplifier (IC503) via the “40M” line, and is then applied to the DDS IC (IC501, pin 88) as the system clock signal. The signal which is output from the IC is applied to the D/A convertor (R510–R533), and then passes through the low-pass filter (L530–L532, C531–C536) to suppress more than 4.5 MHz signals. The filtered signal (4.0–4.0306875 MHz) is applied to the amplifier (IC502, pin 2), and is then applied to the DDS IC’s phase detector section (IC501, pin 47). The signal passes through the loop filter (D541, D542, L541, C545, C546, R548, R554), and is then applied to the oscillator circuit (Q541) to oscillate the 64 MHz reference signal.

The 64 MHz signal is amplified at the buffer amplifier (Q561), and is then applied to the hybrid divider.

A portion of 64 MHz signal passes through the attenuator (R571, R572), and is then applied to the amplifier (Q580). The amplified signal is applied to the DDS IC’s quarter detector section (IC501, pin 80) as the comparison signal.

The 64 MHz signal from the hybrid divider passes through the attenuator (R573–R575), and is then applied to the TX or RX 2nd LO circuit.

(1) TX 2ND LO CIRCUIT

The signal from the attenuator passes through the another attenuator (R587–R589), and is then applied the amplifier (Q591). The signal passes through the bandpass filter to suppress unwanted signals, and is then applied to the TX 2nd mixer circuit (RX-A unit; D505) via the J561.

(2) RX 2ND LO CIRCUIT

The signal from the attenuator (R573–R575) passes through the another attenuator (R802, R803), and is then applied to the amplifier (Q801). The signal passes through the attenuator (R805–R807), and is then applied to the mixer circuit (D821) to mix with TX 3rd LO signal. The mixed signal passes through the attenuator (R831–R833) and bandpass filter (F1831), and is then applied to the amplifier (Q831). The signal passes through the attenuator (R836–R838), and is then applied to the LO (Q1651) and buffer (IC1651, pin 10) amplifiers. The amplified signal is applied to the buffer amplifier (IC1651, pins 1 and 2), and is then applied to the 2nd mixer circuit (IC1501, pin 1) as 2nd LO signal.

A part of amplified signal from buffer amplifier (IC1651, pin 8) passes through the 90 degrees phase inversion circuit (L1652, C1655 and C1656), and is then amplified at the buffer amplifier (IC1651, pins 4 and 5). The amplified signal is applied to the 2nd mixer circuit (IC1502, pin 1) as 2nd LO signal.

• TX 3RD LO CIRCUIT

The 40 MHz reference signal is applied to the amplifier (Q652) via the “40M” line, and is then applied to the DDS IC (IC651, pin 7) as the system clock signal. The signal which is output from the IC is applied to the D/A convertor (R661–R671, R673–R681), and then passes through the low-pass filter (L681, L682, C680–C685) to suppress more than 0.5 MHz signals. The signal is amplified at the buffer amplifier (Q680), and passes through the attenuator (R690–R692). The signal is applied to the TX 3rd mixer circuit (IC502, pin 1) via the J681.

3-3-4 RXPLL-B CIRCUIT

The 10 MHz oscillated signal from the OSC unit is applied to the amplifier (Q30) via the J10, and is then amplified at the quadrupler (Q702) to produce 40 MHz reference signal. The amplified signal passes through the attenuator (R708–R10), and is then applied to the 1st LO, 2nd LO and DSP system clock, scope unit system clock circuits, respectively.

• 1ST LO CIRCUIT

The 40 MHz reference signal is applied to the amplifier (Q104) via the “40M” line, and is then applied to the DDS IC (IC101, pin 88) as the system clock signal.

The signal passes through the D/A convertor (R110–R133). The signal passes through the ceramic filter (F1101) to pass the 10.7 MHz signal, and is then applied to the amplifier (IC102, pin 2). The signal is applied to the DDS IC (IC101, pin 47) again, and is then applied to the phase detector section of the DDS IC. The signal which outputs from the DDS IC (IC101, pin 56) passes through the loop filter (D152–D154, L151, C152–C155), and is then applied to the oscillator circuit (Q150). The circuit oscillates 10.5813219–10.7408384 MHz signal.

The oscillated signal is applied to the amplifier (Q151), and is then applied to the PLL IC.

A part of the oscillated signal is fed back to the DDS IC (IC101, pin 46) via the amplifier (Q152) as the comparison signal.

VCO No.	Parts No.	Display frequency
1	Q220	64.585–72.554999 MHz
2	Q230	72.555–79.554999 MHz
3	Q240	79.555–86.554999 MHz
4	Q250	86.555–94.554999 MHz
5	Q260	94.555–109.554999 MHz
6	Q270	109.555–124.555 MHz

The amplified signal from Q151 is applied to the PLL IC’s 1/21 divider section (IC201, pin 8), and is then applied to the PLL section. The signal outputs from pin 2, and passes through the loop filter (Q202). The filtered signal is applied to the one of the 6 VCOs circuits as follow.

The oscillated signal is amplified at the buffer amplifier (Q301), and passes through the low-pass (L331, C331–C333) and high-pass (D341, L332, C334–C337) filters. The signal is applied to the amplifier (Q302).

A portion of buffer amplified signal from Q301 is fed back to the PLL IC’s 1/N (N=130–250) divider section (IC201, pin 6) as the comparison signal.

The amplified signal from Q302 is applied to another amplifier (Q351), and is then amplified at the buffer amplifier (Q352). The signal passes through the low-pass filter (D441, L441, L442, C441–C446) and attenuator (R364–R366), and is then output from J351 as the RX 1st LO signal (64.585–124.555 MHz) to the RX-B unit.

• 2ND LO CIRCUIT

The 40 MHz reference signal is applied to the amplifier (Q503) via the “40M” line, and is then applied to the DDS IC (IC501, pin 88) as the system clock signal. The signal which is output from the IC is applied to the D/A convertor (R510–R533), and then passes through the low-pass filter (L530–L532, C531–C536) to suppress more than 4.5 MHz signals. The filtered signal (4.0–4.0369735 MHz) is applied to the amplifier (IC502, pin 2), and is then applied to the DDS IC’s phase detector section (IC501, pin 47). The signal passes through the loop filter (D541, D542, L541, C543, C545–C557, R548, R554), and is then applied to the oscillator circuit (Q541) to oscillate the 64.591 MHz reference signal.

The 64.591 MHz signal is amplified at the buffer amplifier (Q561), and is then applied to the hybrid divider.

A portion of 64.591 MHz signal passes through the attenuator (R571, R572), and is then applied to the amplifier (Q580). The amplified signal is applied to the DDS IC’s quarter detector section (IC501, pin 80) as the comparison signal.

The 64.591 MHz signal from the hybrid divider passes through the two attenuators (R573–R575, R587–R589), and is then applied to the amplifier (Q591). The amplified signal passes through the bandpass filter to suppress unwanted signals, and is then applied to the RX 2nd mixer circuit (IC1501, IC1502) as 2nd LO signal via the J561.

• DSP SYSTEM CLOCK CIRCUIT

The 40 MHz reference signal is applied to the amplifier (Q652) via the “40M” line, and is then applied to the DDS IC (IC651, pin 7) as the system clock signal. The signal which is output from the IC is applied to the D/A convertor (R661–R671, R673–R681), and then passes through the low-pass (L681, L682, C680–C685) and high-pass (L683,

C686–C688) filters to suppress unwanted signals. The signal is amplified at the buffer amplifier (Q680), and passes through the attenuator (R690–R692). The signal is applied to the DSP IC for TX (DSP-TX unit; IC1), RX-A (DSP-A unit; IC1) and RX-B (DSP-B unit; IC1) as 12.288 MHz system clock signal via the A/D converters.

• RXPLL-A/B CIRCUITS

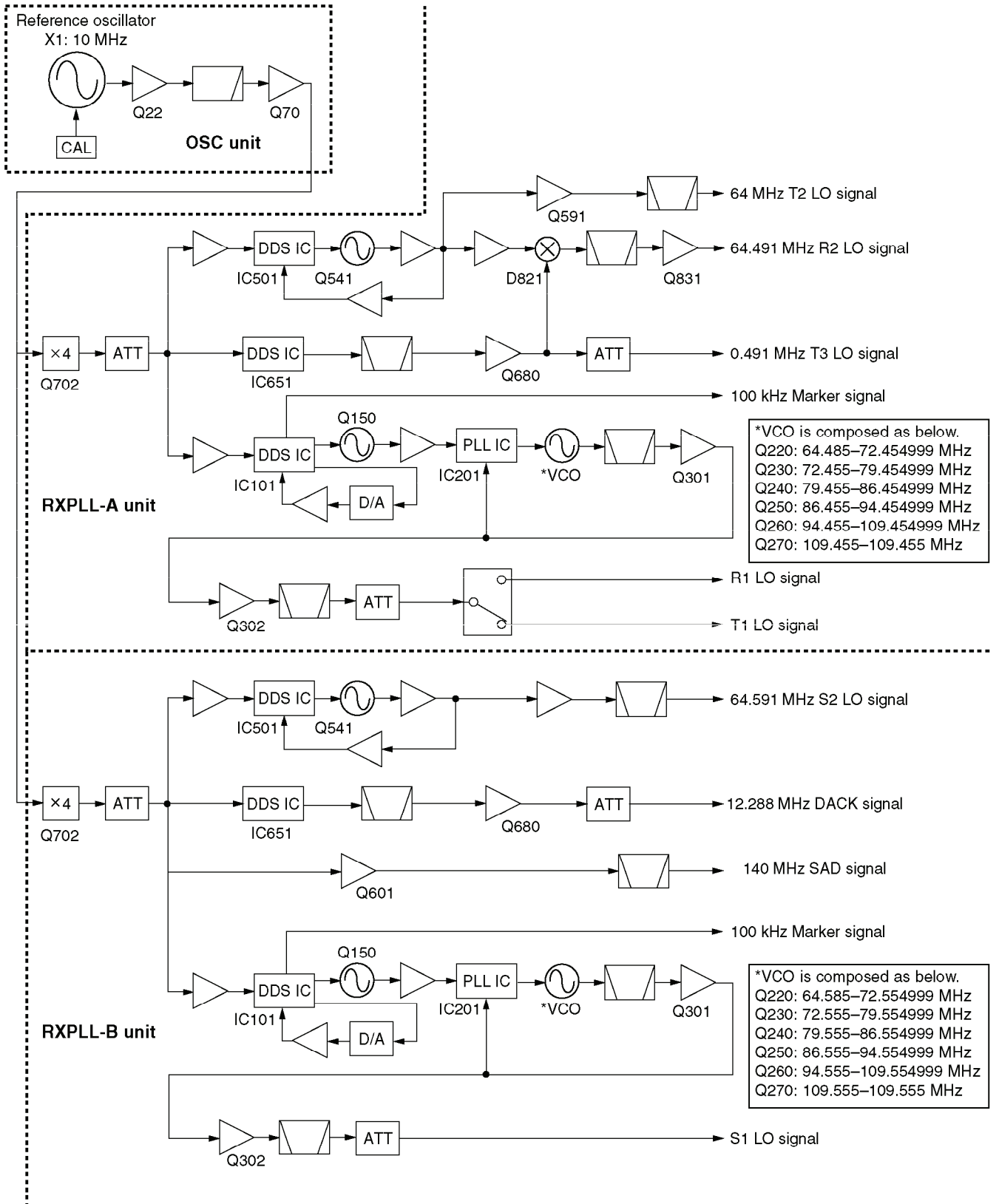

• SCOPE UNIT SYSTEM CLOCK CIRCUIT

The 40 MHz reference signal is amplified at the buffer amplifier (Q601) via the “40M” line, and then passes through the low-pass filter (L602, L603, C609–C613). The filtered signal is applied to the buffer amplifier (SCOPE unit; Q701) as the 40 MHz system clock via the J601.

3-4 ANTENNA TUNER CIRCUITS

3-4-1 MATCHING CIRCUIT (NETWORK BOARD)

The matching circuit is a T-network. Using 2 tuning motors, the matching circuit obtains rapid overall tuning speed.

Using relays (RL50, RL60, RL70, RL80, RL90, RL100, RL110, RL120), the relay control signals from the antenna tuner CPU (CTRL unit; IC1) via the buffer amplifier (IC402) ground one of the taps of L50, L60, L70, L80, L90, L100, L110, L120. After selecting the coils, 2 motors (TUNER unit; MF1, MF2) adjust C1 and C2 using the antenna tuner CPU (CTRL unit; IC1) and the motor controller (CTRL unit; Q3–Q10, D3–D6) to obtain a low SWR (Standing Wave Ratio).

3-4-2 DETECTOR CIRCUIT (CTRL BOARD)

(1) SWR DETECTOR

Forward and reflected power are picked up by a current transformer (L101), detected by D101 and D102, and then amplified at IC101, pin 3 and pin 5, respectively. The amplified voltages are applied to the antenna tuner CPU (IC1, pins 2, 3) via “AN0” and “AN1” lines. The tuner CPU detects the SWR.

(2) REACTANCE COMPONENTS DETECTOR

Reactance components are picked up by comparing the phases of the RF current and RF voltage. The RF current is detected by L151 and R151–R154 and buffer-amplified at IC151, pin 13 and IC154, pin 1 and then applied to the phase comparator (IC156, pin 1). RF voltages are detected by C151–C153, C158 and then applied to the phase comparator (IC156, pin 13) after being amplified at the buffer amplifiers (IC151, IC153). The output signal from the phase comparator (IC156, pin 6 for RF current, IC156 pin 7 for RF voltage) is rectified at D154 and D153 for conversion into DC voltage. The rectified voltage signals are combined, then amplified at the inverter amplifier (IC201, pin 2), then applied to the antenna tuner CPU (IC1, pin 64) via the “AN3” line. A C-MOS IC is used for the buffer amplifier (IC151) to improve functionable sensitivity; the inverter amplifier (IC201) is very responsive even with a low signal level input. Together, these ensure quick and stable signal detection even at low RF signal level input.

(3) RESISTANCE COMPONENTS DETECTOR

Resistance components are picked up by L201, and detected by D201, D202 and Q201. The detected resistance components are amplified at the inverter amplifier (IC201, pin 6), and then applied to the antenna tuner CPU (IC1, pin 1) via the “AN2” line.

3-4-3 MOTOR CONTROL CIRCUIT (CTRL AND TUNER UNITS)

The control circuit of the internal antenna tuner consists of the CPU, EEPROM (Electrically-Erasable Programmable Read Only Memory), tuning motors and tuning relays.

(1) CPU AND EEPROM (CTRL UNIT)

The antenna tuner CPU (IC1) controls the tuning motors via the motor controller (Q3–Q10, D3–D6) and tuning relays, and memorizes the best preset position in 100 kHz steps. The memory contents are stored in the EEPROM (IC2) without a backup battery.

(2) TUNING MOTORS (CTRL AND TUNER UNITS)

A motor controller (Q3–Q10 D3–D6) rotates the tuning motors (TUNER unit; MF1, MF2) to obtain a low SWR.

(3) TUNING RELAYS (TUNER UNIT)

According to the operating frequency band and antenna condition, tuning relays select the capacitors and coils.

3-4-4 ANTENNA TUNER CPU PORT ALLOCATION (CTRL unit; IC1)

Pin number	Port name	Description
1	AN2	Input port for the resistance components detection voltage.
2	AN1	Input port for the reflected RF power voltage.
13	IKEY	Outputs tuner data signal.
15	IKEYB	Input port for the serial signal.
17	THRU	Input port for the [TUNER] ON/OFF signal.
21	TRC	Input port for the TX/RX switching signal.
22, 23	#CL1, CL2	Input port for the antenna tuner CPU system clock.
26	VHF	Outputs the coil selection signal. High : While 46–60 MHz band is displayed.
27–32	L24M, L18M, L14M, L10M, L7M, L3.5M	Output the coil selection signal.
34–40	CO3, CO2, CO1, C13, C12, C11	Output the capacitor selection signal.
41–48	AZ, AY, AX, AW, PZ, PY, PX, PW	Output pulse-type control signals for the tuning motors (MF1, MF2).
64	AN3	Input port for the reactance components detection voltage.

3-5 SCOPE CIRCUITS

3-5-1 SCOPE RECEIVER CIRCUIT (SCOPE UNIT)

A portion of the 64.455 MHz 1st IF signal from the 1st mixer circuit (RXPLL-A/B units; IC1051, Q1211 and Q1212: while receiving) or IF amplifier (MAIN unit; Q506: while transmitting) passes through the switches (IC1 and IC31). The signal is passed through the PIN attenuator (D1 and D2) and amplified at the IF amplifiers (Q2), and then mixed with the 18.455–20.455 MHz scope 2nd LO (S2LO) signal at the mixer circuit (D101) to produce the 45 MHz IF signal. The mixed IF signal is passed through the ceramic bandpass filters (FI201) to suppress unwanted signals. The filtered IF signal is applied to other mixer (D4) after amplifying at 2 amplifiers (Q201 and Q202). The signal is applied to the amplifier (IC401, pin 6), and then passes through the low-pass filter (IC403, pins 6 and 1). The filtered signal is amplified at the amplifier (IC404, pin 6), and is then applied to the DSP IC (IC601) via the A/D converter (IC501, pin 43). The DSP IC analyzes digital signals, and then outputs digital data to the CPU.

3-5-2 SCOPE UNIT AGC CIRCUIT (SCOPE UNIT)

One of the filtered signal at the low-pass filter (IC403, pin 1) is applied to the amplifier (IC404, pin 6). The amplified signal is applied to the AGC detector (D401 and D402), and is then applied to the AGC amplifier (IC405, pin 2). The amplified signal is applied to the comparator section of one to compare with "ATTV" signal. The signal is amplified at the AGC amplifier (Q1), and is then applied to the PIN attenuator (D1 and D2) to keep same gain.

3-5-3 SWEEP LO CIRCUIT (SCOPE UNIT)

The 40 MHz signal is applied to the J3 from the RXPLL-B unit. The signal is used for reference system clock of each circuits.

(1) S2 LO CIRCUIT

The 40 MHz reference system clock is amplified at the amplifiers (Q701 and Q720). The signal is applied to the 14 bits DDS IC (IC820, pin 62). The DDS IC which is controlled by the CPU outputs 19.555 MHz (for MAIN RX) or 19.555±0.5 MHz (for SUB RX) system clock from pin 45, and then passes through the low-pass filter (L761–L763, C761–C767), high-pass filter (L764, C768–C770) and attenuator (R764–R766). The attenuated signal is applied to the LO amplifier (Q101), and then passes through the low-pass filter (L104, C108–C110) and attenuator (R105–R107). The attenuated signal is applied to the mixer circuit (D101) as S2 LO signal (19.555–20.455 MHz).

(2) S3 LO CIRCUIT

The 40 MHz reference system clock is amplified at the amplifiers (Q701 and Q810). The signal is applied to the PLL IC (IC801, pin 8). The signal passes through the 1/400 divider and phase detector circuit of the IC, and is then applied to the VCO circuit (Q821) via the loop filter to produce 44.8 MHz signal. The 44.8 MHz signal is amplified at the buffer amplifiers (Q841–Q843), and then passes through the low-pass filter (L851, L852, C852–C856) to suppress high-harmonics components. The filtered signal passes through the attenuator (R856–R858), and is then amplified at the amplifier (Q301). The signal passes through the other attenuator (R302–R304), and is then applied to the mixer circuit (D4) as S3 LO signal.

• SCOPE CIRCUIT

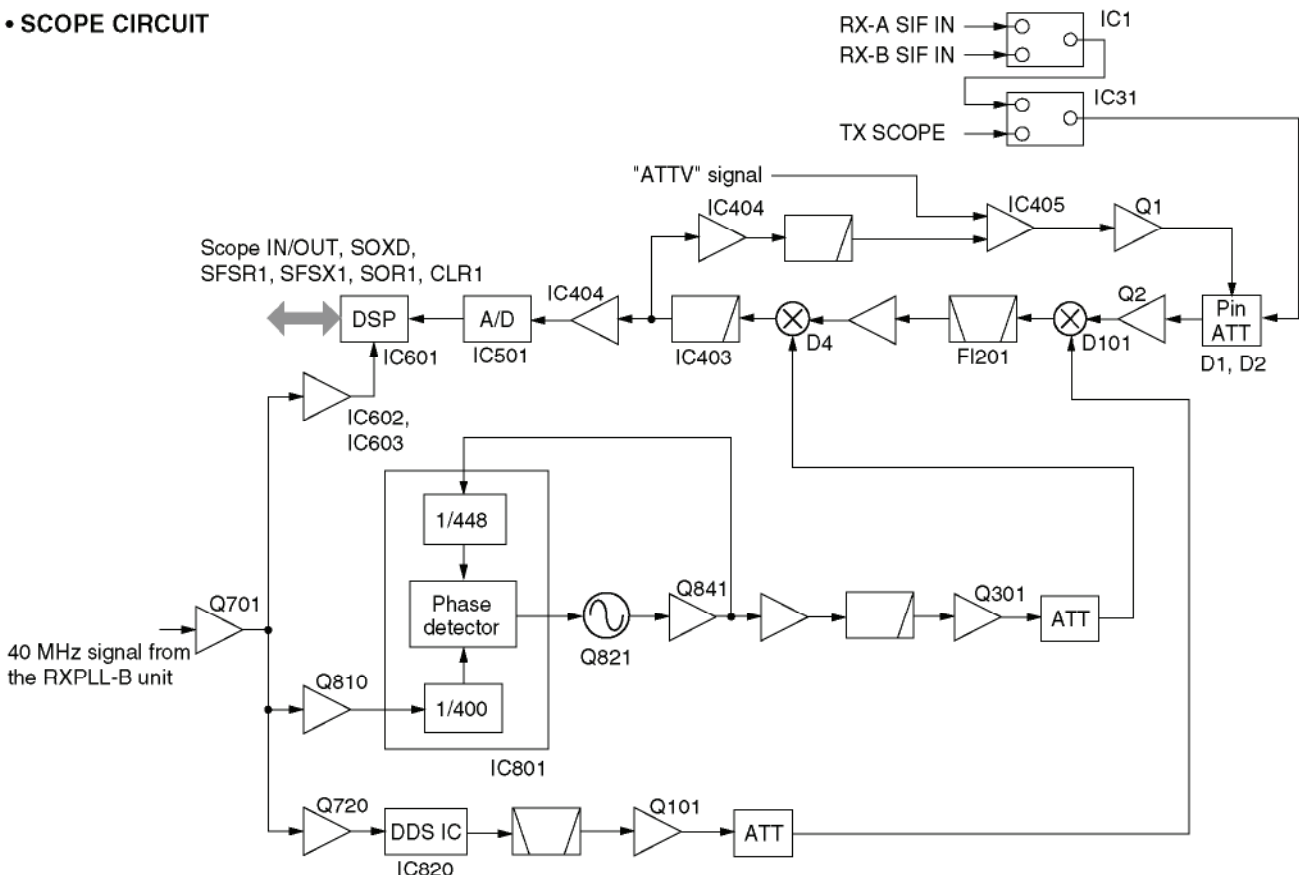

(3) DDS LO CIRCUIT

The 40 MHz reference system clock is amplified at the amplifiers (Q701, IC602 and IC603), and is then applied to the DSP IC (IC601). The applied signal is quintupled in the IC, then uses 200 MHz DSP system clock signal.

The 200 MHz clock signal is divided 1/400, and then uses as the 500 kHz sampling frequency of the A/D converter (IC501).

3-6 POWER SUPPLY CIRCUITS

3-6-1 VOLTAGE LINES (DC-DC UNIT)

LINE	DESCRIPTION
C15V	Common 15 V line from the REG unit. The voltage is applied to the LOGIC unit via the J3, pin 6.
H8V	Common 8 V from the REG unit. The signal is applied to the regulator circuits on the DC-DC unit.
+15V	The same voltage as the +15 line passed through the switching relay (RL142). The voltage is applied to the PA200W board (via J420, pins 1 and 2), LOGIC (via the J820, pins 4–6) and MAIN (via the J450, pin 3) units.
-12V	Common -12 V converted from the +15 V line and regulated by the -12V regulator circuit (IC121). The voltage is applied to the LOGIC (via the J820, pin 3) and MAIN (via the J450, pin 2) units.
VDD1R5	Common 5 V converted from the H8V line and regulated by the VDD1R5 regulator circuit (IC101). The voltage is applied to the LOGIC unit via the J821, pin 2.
5V	Common 5 V converted from the H8V line and regulated by the VDD5 regulator circuit (IC81). The voltage is applied to the LOGIC (via the J821, pin 4) and MAIN (via the J450, pin 10) units.
+8V	The same voltage as the H8V line passed through the switching relay (RL142). The voltage is applied to LOGIC (via the J820, pin 7) and MAIN (via the J450, pin 4) units.
+5V	Common 5 V converted from the +8V line and regulated by the +5V regulator circuit (IC61). The voltage is applied to the LOGIC (via the J820, pin 8) and MAIN (via the J450, pin 4) units.
+3R3V	Common 3 V converted from the +8V line and regulated by the +3R3V regulator circuit (IC41). The voltage is applied to the LOGIC (via the J820, pin 9) and MAIN (via the J450, pin 6–8) units.
VDD3R3	Common 3 V converted from the H8V line and regulated by the VDD3R3 regulator circuit (IC21). The voltage is applied to the LOGIC unit via the J821, pin 3.

• MAIN AND SUB 1ST LO FREQUENCY LIST (FOR RECEIVING)

MODE	MAIN 1ST LO FREQUENCY (MHz)	SUB 1ST LO FREQUENCY (MHz)
USB	64.4865–124.4565	64.5865–124.5565
LSB	64.4835–124.4535	64.5835–124.5535
CW	64.4850–124.4550	64.5850–124.5550
RTTY	64.48483–124.45483	64.58483–124.55483
PSK31	64.4850–124.4550	64.5850–124.5550
AM	64.4850–124.4550	64.5850–124.5550
FM	64.4850–124.4550	64.5850–124.5550

• MAIN AND SUB 2ND FREQUENCY LIST (FOR RECEIVE)

MODE	MAIN 2ND LO FREQUENCY (kHz)	SUB 2ND LO FREQUENCY (MHz)
USB	64.4925	64.5925
LSB	64.4895	64.5985
CW*1	64.4910 - CW PITCH	64.5910 - CW PITCH
RTTY*2	64.48868	64.58868
PSK31	64.4925	64.5925
AM	64.4910	64.5910
FM	64.4910	64.5910

*1CW-PITCH: 300–900 Hz, *2RTTY TONE: 21.25 Hz; SHIFT: 170 Hz

• 3RD IF AND LO FREQUENCY LIST (FOR TRANSMIT)

MODE	3RD IF FREQUENCY (kHz)	3RD LO FREQUENCY (kHz)
USB	36.000	492.500
LSB	36.000	489.500
CW	36.000	491.000
RTTY*	33.875	488.705
PSK31	36.000	491.000
AM	36.000	491.000
FM	36.000	491.000

*RTTY TONE: 21.25 Hz; SHIFT: 170 Hz

• 2ND IF AND LO FREQUENCY LIST (FOR TRANSMIT)

MODE	2ND IF FREQUENCY (kHz)	2ND LO FREQUENCY (MHz)
USB	456.500	64.000
LSB	453.500	
CW	455.000	
RTTY	454.830	
PSK31	455.000	
AM	455.000	
FM	455.000	

• 1ST IF FREQUENCY LIST (FOR TRANSMIT)

MODE	1ST IF FREQUENCY (MHz)
USB	64.45650
LSB	64.45350
CW	64.45500
RTTY	64.45483
PSK31	64.45500
AM	64.45500
FM	64.45500

• 1ST LO FREQUENCY LIST (FOR TRANSMIT)

BAND (MHz)	LO FREQUENCY (MHz)	BAND (MHz)	LO FREQUENCY (MHz)
1.9	66.2580–66.2800	10	66.2580–66.2800
	66.3625–66.3675	14	66.3625–66.3675
3.5	67.9550–68.0300	18	67.9550–68.0300
3.8	68.2020–68.2090	21	68.2020–68.2090
	68.2460–68.2600	24	68.2460–68.2600
4.63	69.0850	28	69.0850
7	71.4550–71.5550	50	71.4550–71.5550

SECTION 4 ADJUSTMENT PROCEDURES

4-1 PREPARATION BEFORE SERVICING

■ REQUIRED TEST EQUIPMENT

EQUIPMENT	GREDE AND RANGE	EQUIPMENT	GREDE AND RENGE
AC outlet	Voltage : 85 V–265 V	Audio generator	Frequency range : 300–3000 Hz Measuring range : 1–500 mV
RF power meter (terminated type)	Measuring range : 250–300 W Frequency range : 1.8–100 MHz Impedance : 50 Ω SWR : Less than 1.2 : 1	Standard signal generator (SSG)	Frequency range : 0.1–100 MHz Output level : 0.1 μV–32 mV (–127 to –17 dBm)
Frequency counter	Frequency range : 0.1–100 MHz Frequency accuracy : ±0.5 ppm or better Sensitivity : 100 mV or better	Digital multimeter	Input impedance : 10 MΩ/DC or beter
RF voltmeter	Frequency range : 0.1–100 MHz Measuring range : 0.01–10 V	AC millivoltmeter	Measuring range : 10 mV–10 V
FM deviation meter	Frequency range : DC–500 MHz Measuring range : 0 to ±5 kHz	DC voltmeter	Input impedance : 50 kΩ/V DC or better
Modulation analyzer	Frequency range : At least 90 MHz Measuring range : 0–100 %	DC ammeter	Measurement capability: 1 A/30 A
Distortion meter	Frequency range : 1 kHz ±10 % Measuring range : 1–100 %	Spectrum analyzer	Frequency range : At least 90 MHz Spectrum bandwidth : 100 kHz or more
Oscilloscope	Frequency range : DC–20 MHz Measuring range : 0.01–20 V	Attenuator	Power attenuation : 50 or 60 dB Capacity : 200 W or more
		External speaker	Input impedance : 8 Ω Capacity : 5 W or more
		Terminator	Resistance : 50 and 150 Ω Capacity : 200 W or more

■ CONNECTIONS

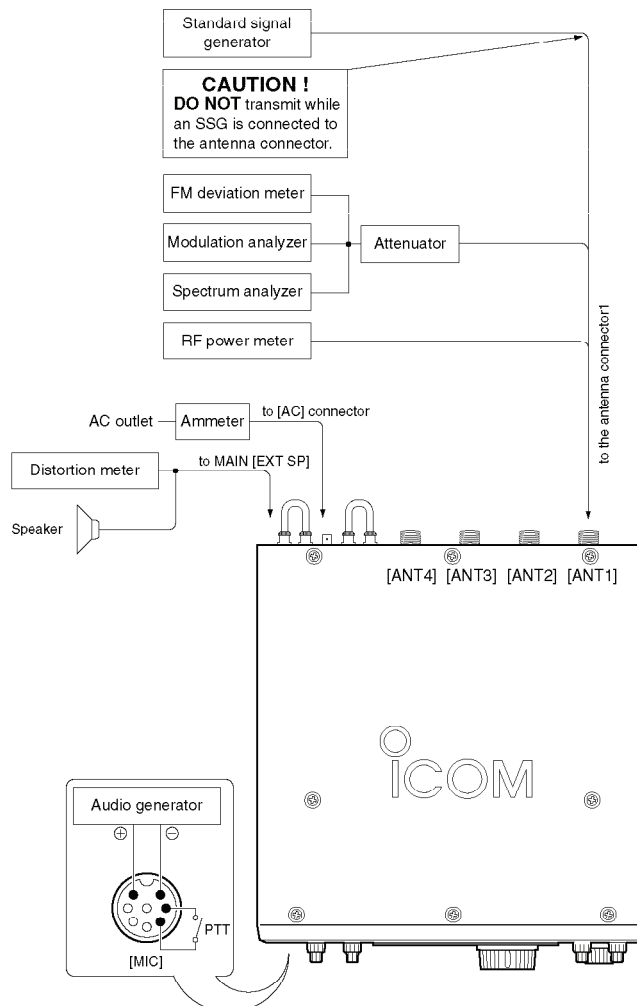

4-2 OSC UNIT ADJUSTMENTS

ADJUSTMENT	ADJUSTMENT CONDITION	MEASUREMENT		VALUE	ADJUSTMENT POINT	
		UNIT	LOCATION		UNIT	ADJUST
REFERENCE OUTPUT	1 <ul style="list-style-type: none"> • Set the OSC unit to the external reference mode on the set mode. • MAIN display frequency : 10.000 MHz • Connect an SSG to J71 on the OSC unit and set as : <ul style="list-style-type: none"> Frequency : 10.000 MHz Level : 71 mV* (-10 dBm) Modulation : OFF • Terminates J73 with 50 Ω. • Receiving 	OSC	Connect an RF voltmeter to the J72.	Maximum voltage	OSC	L61, L62
REF IN OUTPUT	2 <ul style="list-style-type: none"> • Receiving 	OSC	Connect an RF voltmeter to the J72.	0 dBm ±3.0 dB		Verify
	<ul style="list-style-type: none"> • Terminates J72 with 50 Ω. • Receiving 		Connect an RF voltmeter to the J73.	0 dBm ±3.0 dB		Verify
REF OUT OUTPUT	3 <ul style="list-style-type: none"> • Set the OSC unit to the internal reference mode on the set mode. • Receiving 	OSC	Connect an RF voltmeter to the J71.	-10.0 dBm ±3.0 dB		Verify
	<ul style="list-style-type: none"> • Terminates J73 with 50 Ω. • Receiving 		Connect an RF voltmeter to the J72.	0 dBm ±3.0 dB		Verify
	<ul style="list-style-type: none"> • Terminates J72 with 50 Ω. • Receiving 		Connect an RF voltmeter to the J73.	0 dBm ±3.0 dB		Verify

*This output level of a standard signal generator (SSG) is indicated as SSG's open circuit.

• OSC UNIT TOP VIEW

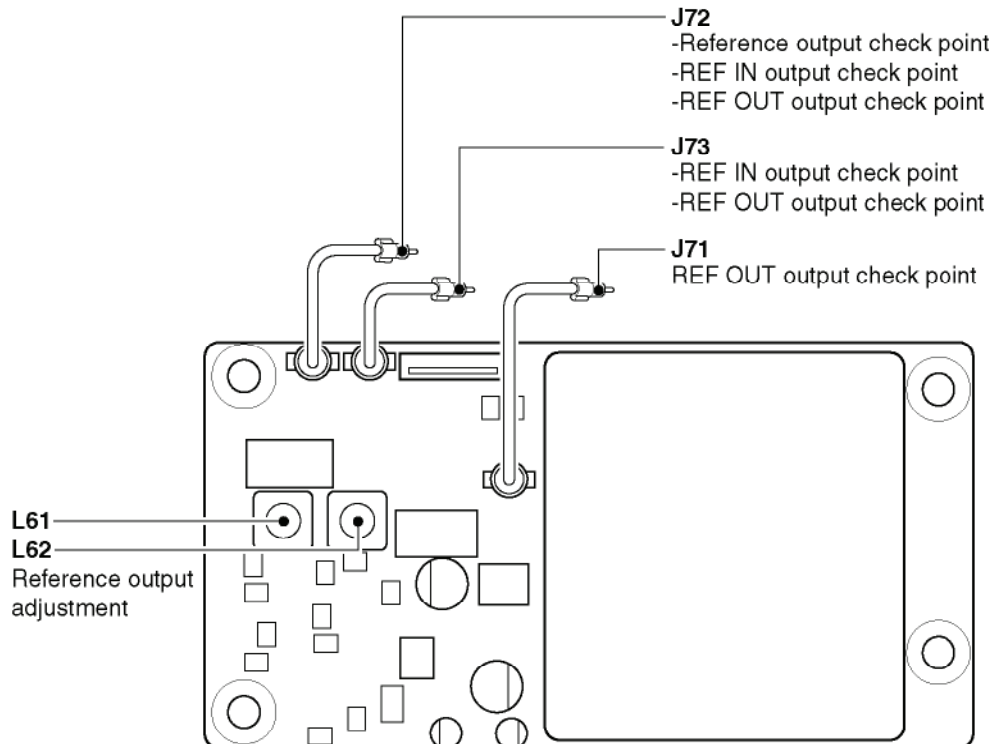
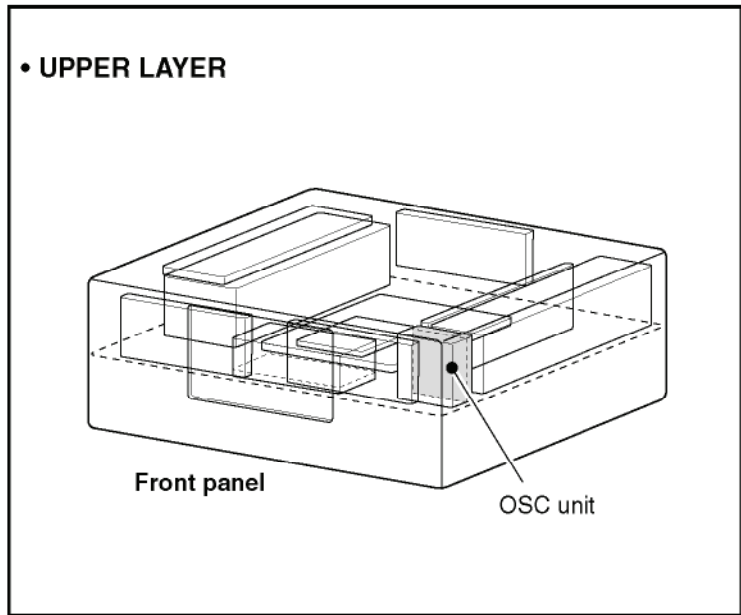

4-3 RXPLL-A UNIT ADJUSTMENTS

ADJUSTMENT	ADJUSTMENT CONDITION	MEASUREMENT		VALUE	ADJUSTMENT POINT	
		UNIT	LOCATION		UNIT	ADJUST
40M OUTPUT	1 <ul style="list-style-type: none"> MAIN display frequency : 0.030 MHz Mode : USB Receiving 	RX PLL-A	Connect an RF voltmeter to the CP701 (40MHz).	Maximum voltage	RX PLL-A	L702, L703
LPL LOCK VOLTAGE	1 <ul style="list-style-type: none"> MAIN display frequency : 0.030 MHz Mode : USB Receiving 	RX PLL-A	Connect a DC voltmeter to the CP1 (LV1).	2.0 V \pm 0.1 V	RX PLL-A	C154
	2 <ul style="list-style-type: none"> MAIN display frequency : 7.999 MHz Mode : USB Receiving 			Less than 3.0 V		Verify
HPL LOCK VOLTAGE (VCO1)	1 <ul style="list-style-type: none"> MAIN display frequency : 7.999 MHz Mode : USB Receiving 	RX PLL-A	Connect a DC voltmeter to the CP2 (LV2).	6.0 V \pm 0.1 V	RX PLL-A	C222
(VCO2)	2 <ul style="list-style-type: none"> MAIN display frequency : 14.999 MHz Mode : USB Receiving 			6.0 V \pm 0.1 V		C232
(VCO3)	3 <ul style="list-style-type: none"> MAIN display frequency : 21.999 MHz Mode : USB Receiving 			6.0 V \pm 0.1 V		C242
(VCO4)	4 <ul style="list-style-type: none"> MAIN display frequency : 29.999 MHz Mode : USB Receiving 			6.0 V \pm 0.1 V		C252
(VCO5)	5 <ul style="list-style-type: none"> MAIN display frequency : 44.999 MHz Mode : USB Receiving 			6.0 V \pm 0.1 V		C262
(VCO6)	6 <ul style="list-style-type: none"> MAIN display frequency : 60.000 MHz Mode : USB Receiving 			6.0 V \pm 0.1 V		C272
(VCO1)	7 <ul style="list-style-type: none"> MAIN display frequency : 0.030 MHz Mode : USB Receiving 	RX PLL-A	Connect a DC voltmeter to the CP2 (LV2).	1.8 V–2.8 V		Verify
(VCO2)	8 <ul style="list-style-type: none"> MAIN display frequency : 8.000 MHz Mode : USB Receiving 			1.8 V–2.8 V		Verify
(VCO3)	9 <ul style="list-style-type: none"> MAIN display frequency : 15.000 MHz Mode : USB Receiving 			1.8 V–2.8 V		Verify
(VCO4)	10 <ul style="list-style-type: none"> MAIN display frequency : 22.000 MHz Mode : USB Receiving 			1.8 V–2.8 V		Verify
(VCO5)	11 <ul style="list-style-type: none"> MAIN display frequency : 30.000 MHz Mode : USB Receiving 			1.8 V–2.8 V		Verify

• RXPLL-A UNIT TOP VIEW

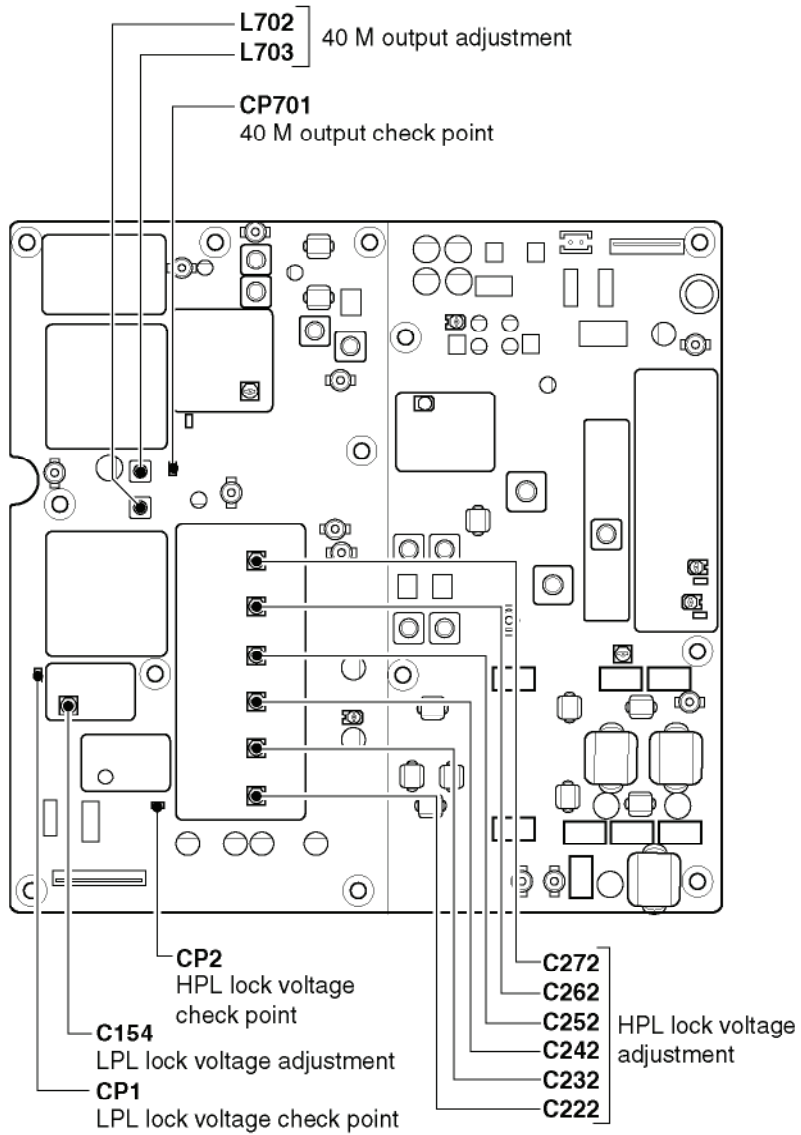
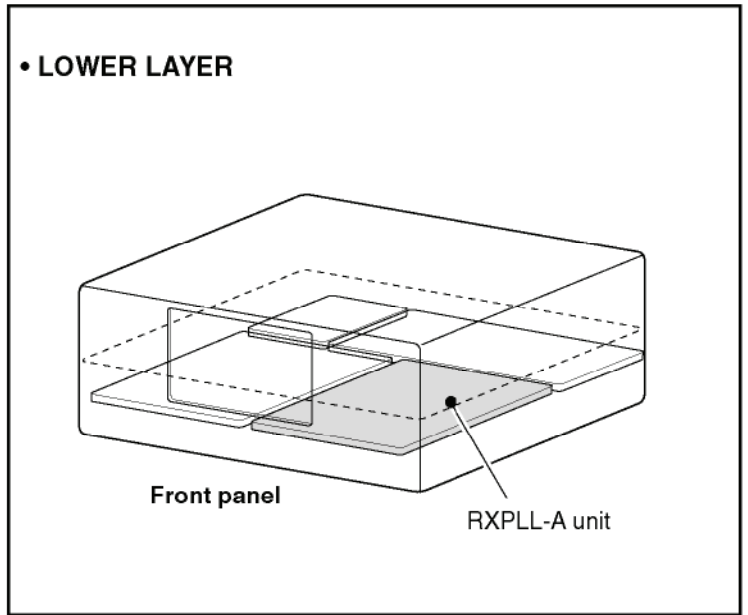

RXPLL-A UNIT ADJUSTMENTS—Continued

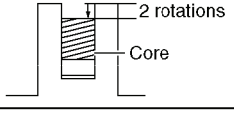
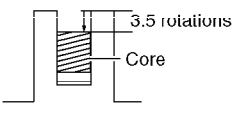
ADJUSTMENT		ADJUSTMENT CONDITION	MEASUREMENT		VALUE	ADJUSTMENT POINT	
			UNIT	LOCATION		UNIT	ADJUST
HPL LOCK VOLTAGE (VCO6)	12	<ul style="list-style-type: none"> MAIN display frequency : 45.0 MHz Mode : USB Receiving 	RX PLL-A	Connect a DC voltmeter to the CP2 (LV2).	1.8 V–2.8 V		Verify
R1 LO OUTPUT	1	<ul style="list-style-type: none"> MAIN display frequency : 14.999 MHz Mode : USB Receiving 	RX PLL-A	Connect an RF voltmeter to the J351 (R1LO).	2.25 dBm \pm 0.25 dB	RX PLL-A	R357
2LO LOCK VOLTAGE	1	<ul style="list-style-type: none"> MAIN display frequency : 14.100 MHz Mode : USB Receiving 	RX PLL-A	Connect an DC voltmeter to the CP3.	1.5 V \pm 0.3 V	RX PLL-A	C546
R2 LO OUTPUT	1	<ul style="list-style-type: none"> MAIN display frequency : 14.100 MHz Mode : USB Receiving 	RX PLL-A	Connect a spectrum analyzer to the J831 (R2LO).	Maximum level (–10 dBm \pm 3.0 dB)	RX PLL-A	L801, L834
T2 LO OUTPUT	1	<ul style="list-style-type: none"> MAIN display frequency : 14.100 MHz Mode : USB Receiving 	RX PLL-A	Connect a spectrum analyzer to the J561 (T2LO).	Maximum level (3.0 dBm \pm 3.0 dB)	RX PLL-A	L565, L566
	2	Repeat the above adjustment sometimes.					
RX SENSITIVITY	1	Pre-set the IC-7800 as below condition. <ul style="list-style-type: none"> MAIN display frequency : 14.150 MHz Mode : USB Dualwatch : OFF MAIN Ant. : ANT1 Pre-amp. 1 : ON SUB AF : Minimum level Receiving 	RX PLL-A	Connect a DC voltmeter to the CP1102.	4.5 V \pm 0.1 V	RX PLL-A	R1101
				Connect a DC voltmeter to the CP1103.	4.5 V \pm 0.1 V	RX PLL-A	R1132
					Center position		R1228
							L1401 L1402
				L1403 L1404			
(HF)	2	<ul style="list-style-type: none"> MAIN display frequency : 14.150 MHz Mode : USB Connect an SSG to [ANT1] connector and set as : <ul style="list-style-type: none"> Frequency : 14.1515 MHz Level : 1 μV* (–107 dBm) Modulation: OFF Receiving 	Rear panel	Connect an AC millivolt meter to the [EXT SP] jack with 8 Ω load.	Maximum audio level	RX PLL-A	L1408, L1058
IMAGE RESPONSE	1	<ul style="list-style-type: none"> MAIN display frequency : 14.150 MHz Mode : USB Connect an SSG to [ANT1] connector and set as : <ul style="list-style-type: none"> Frequency : 14.0765 MHz Level : 50 mV* (–13 dBm) Modulation: OFF Receiving 	Rear panel	Connect a AC millivoltmeter to the [EXT SP] jack with 8 Ω load.	Minimum image	RX PLL-A	R1516, C1656
	2	Repeat the above adjustment sometimes.					

*This output level of a standard signal generator (SSG) is indicated as SSG's open circuit.

• RXPLL-A UNIT TOP VIEW

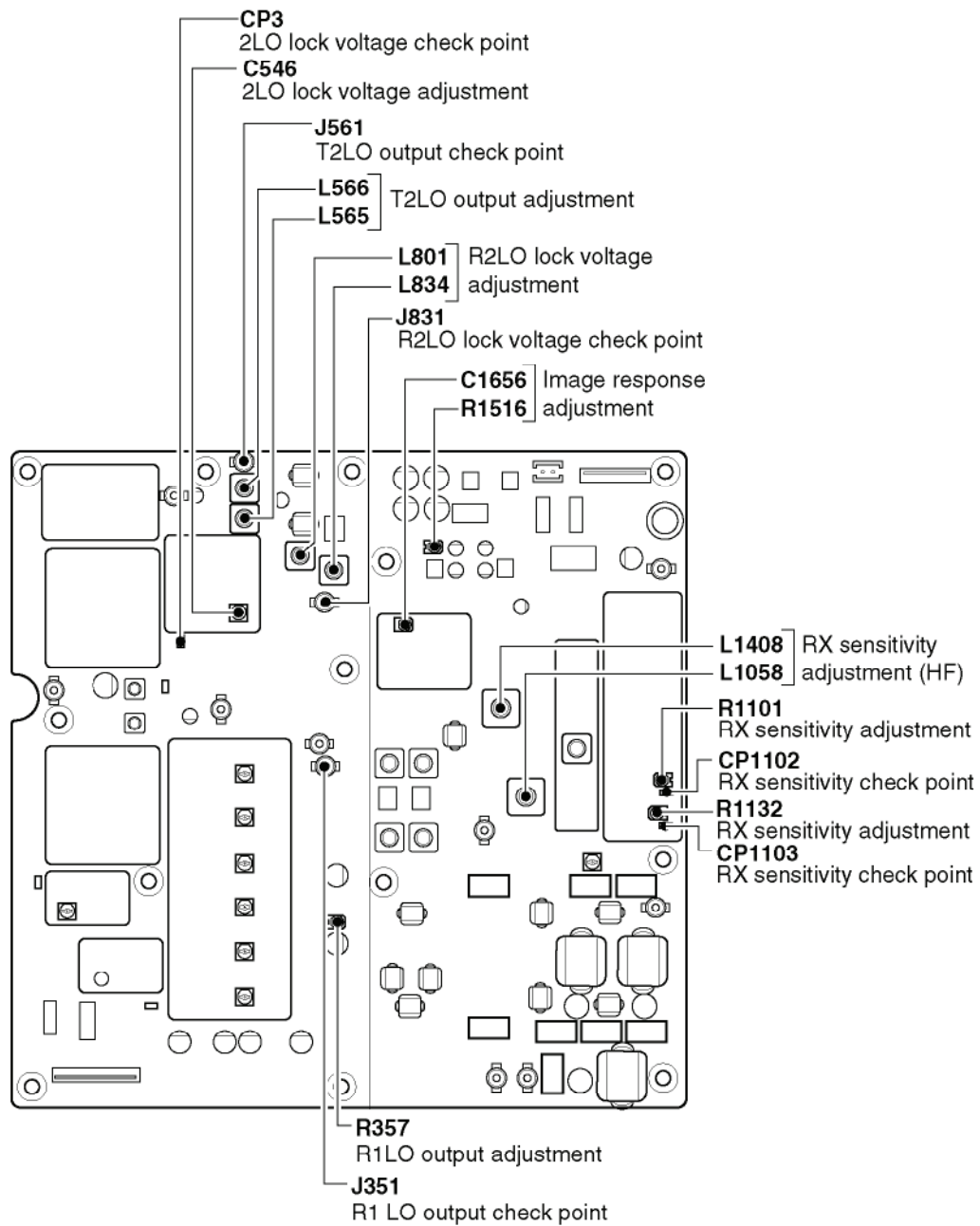
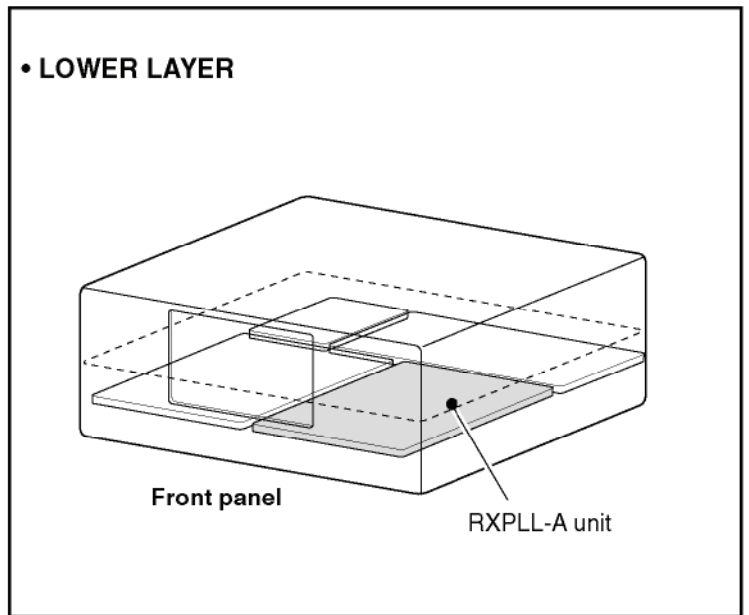

RXPLL-A UNIT ADJUSTMENTS—Continued

ADJUSTMENT	ADJUSTMENT CONDITION	MEASUREMENT		VALUE	ADJUSTMENT POINT	
		UNIT	LOCATION		UNIT	ADJUST
RX SENSITIVITY (50 MHz)	1 <ul style="list-style-type: none"> MAIN display frequency : 50.020 MHz Mode : USB Pre-amp. 2 : ON Connect an SSG to [ANT1] connector and set as : <ul style="list-style-type: none"> Frequency : 50.0215 MHz Level : 0.32 μV[*] (-117 dBm) Modulation: OFF Receiving 	Rear panel	Connect an AC millivolt meter to the [EXT SP] jack with 8 Ω load.	Maximum audio level	RX PLL-A	L1222
IF THROUGH (50 MHz)	1 <ul style="list-style-type: none"> MAIN display frequency : 50.020 MHz Mode : USB Connect an SSG to [ANT1] connector and set as : <ul style="list-style-type: none"> Frequency : 64.455 MHz Level : 50 mV[*] (-13 dBm) Modulation: OFF Receiving 	Front panel	S-meter	Minimum level	RX PLL-A	C1265

*This output level of a standard signal generator (SSG) is indicated as SSG's open circuit.

• RXPLL-A UNIT TOP VIEW

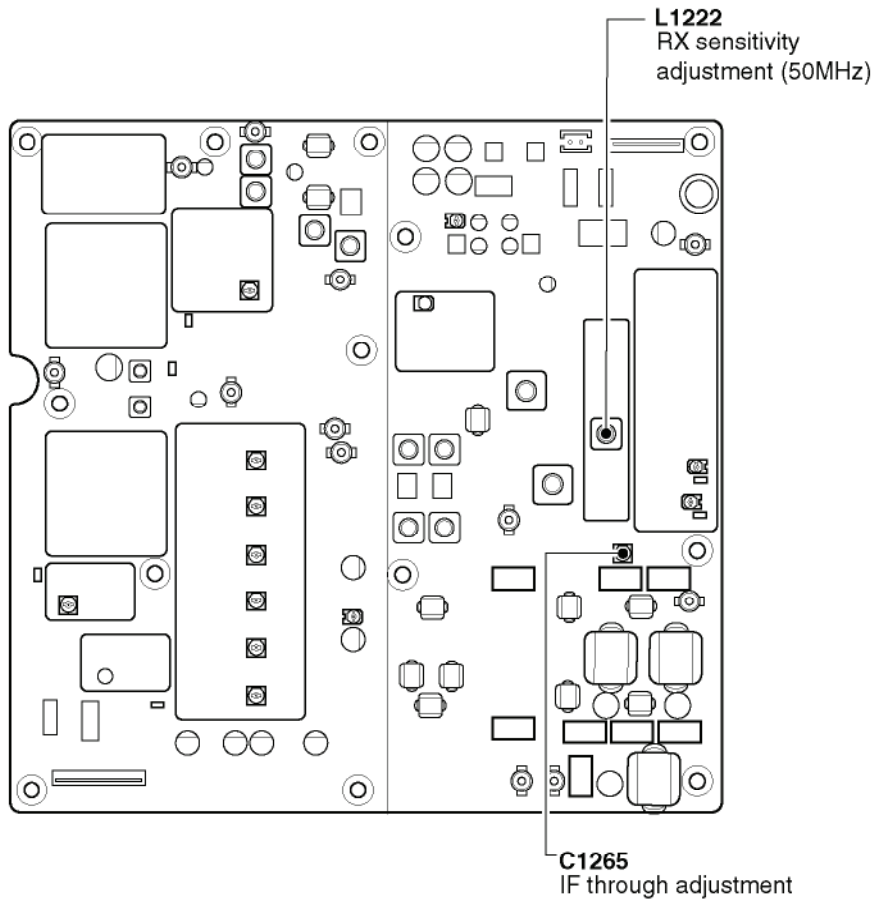
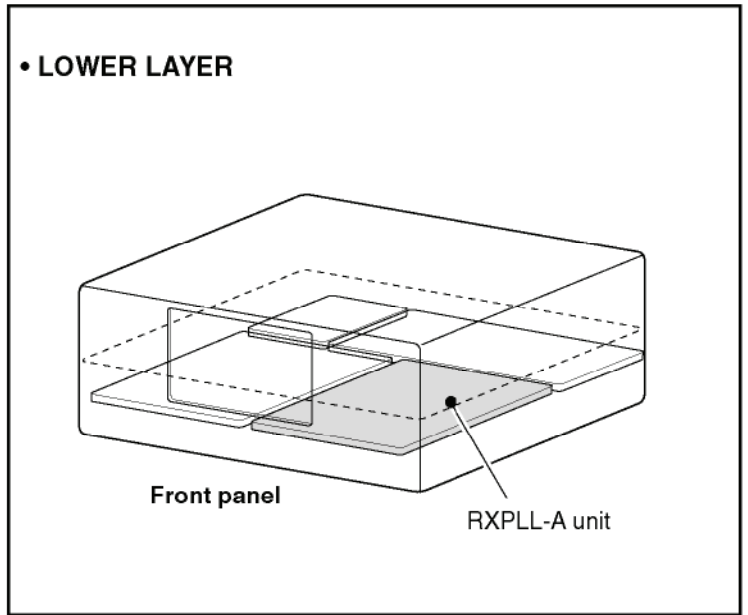

4-4 RXPLL-B UNIT ADJUSTMENTS

ADJUSTMENT	ADJUSTMENT CONDITION	MEASUREMENT		VALUE	ADJUSTMENT POINT	
		UNIT	LOCATION		UNIT	ADJUST
40M OUTPUT	1 <ul style="list-style-type: none"> • Dualwatch : ON • SUB display frequency : 60.000 MHz • Mode : USB • Receiving 	RX PLL-B	Connect an RF voltmeter to the CP701 (40MHz).	Maximum voltage	RX PLL-B	L702, L703
LPL LOCK VOLTAGE	1 <ul style="list-style-type: none"> • SUB display frequency : 60.000 MHz • Mode : USB • Receiving 	RX PLL-B	Connect a DC voltmeter to the CP1 (LV1).	2.0 V \pm 0.1 V	RX PLL-B	C154
	2 <ul style="list-style-type: none"> • SUB display frequency : 1.499 MHz • Mode : USB • Receiving 			Less than 4.0 V		Verify
HPL LOCK VOLTAGE (VCO1)	1 <ul style="list-style-type: none"> • SUB display frequency : 7.999 MHz • Mode : USB • Receiving 	RX PLL-B	Connect a DC voltmeter to the CP2 (LV2).	6.0 V \pm 0.1 V	RX PLL-B	C222
(VCO2)	2 <ul style="list-style-type: none"> • SUB display frequency : 14.999 MHz • Mode : USB • Receiving 			6.0 V \pm 0.1 V		C232
(VCO3)	3 <ul style="list-style-type: none"> • SUB display frequency : 21.999 MHz • Mode : USB • Receiving 			6.0 V \pm 0.1 V		C242
(VCO4)	4 <ul style="list-style-type: none"> • SUB display frequency : 29.999 MHz • Mode : USB • Receiving 			6.0 V \pm 0.1 V		C252
(VCO5)	5 <ul style="list-style-type: none"> • SUB display frequency : 44.999 MHz • Mode : USB • Receiving 			6.0 V \pm 0.1 V		C262
(VCO6)	6 <ul style="list-style-type: none"> • SUB display frequency : 60.000 MHz • Mode : USB • Receiving 			6.0 V \pm 0.1 V		C272
(VCO1)	7 <ul style="list-style-type: none"> • SUB display frequency : 0.030 MHz • Mode : USB • Receiving 	RX PLL-B	Connect a DC voltmeter to the CP2 (LV2).	1.8 V–2.8 V	RX PLL-B	Verify
(VCO2)	8 <ul style="list-style-type: none"> • SUB display frequency : 8.000 MHz • Mode : USB • Receiving 			1.8 V–2.8 V		Verify
(VCO3)	9 <ul style="list-style-type: none"> • SUB display frequency : 15.000 MHz • Mode : USB • Receiving 			1.8 V–2.8 V		Verify
(VCO4)	10 <ul style="list-style-type: none"> • SUB display frequency : 22.000 MHz • Mode : USB • Receiving 			1.8 V–2.8 V		Verify
(VCO5)	11 <ul style="list-style-type: none"> • SUB display frequency : 30.000 MHz • Mode : USB • Receiving 			1.8 V–2.8 V		Verify

• RXPLL-B UNIT TOP VIEW

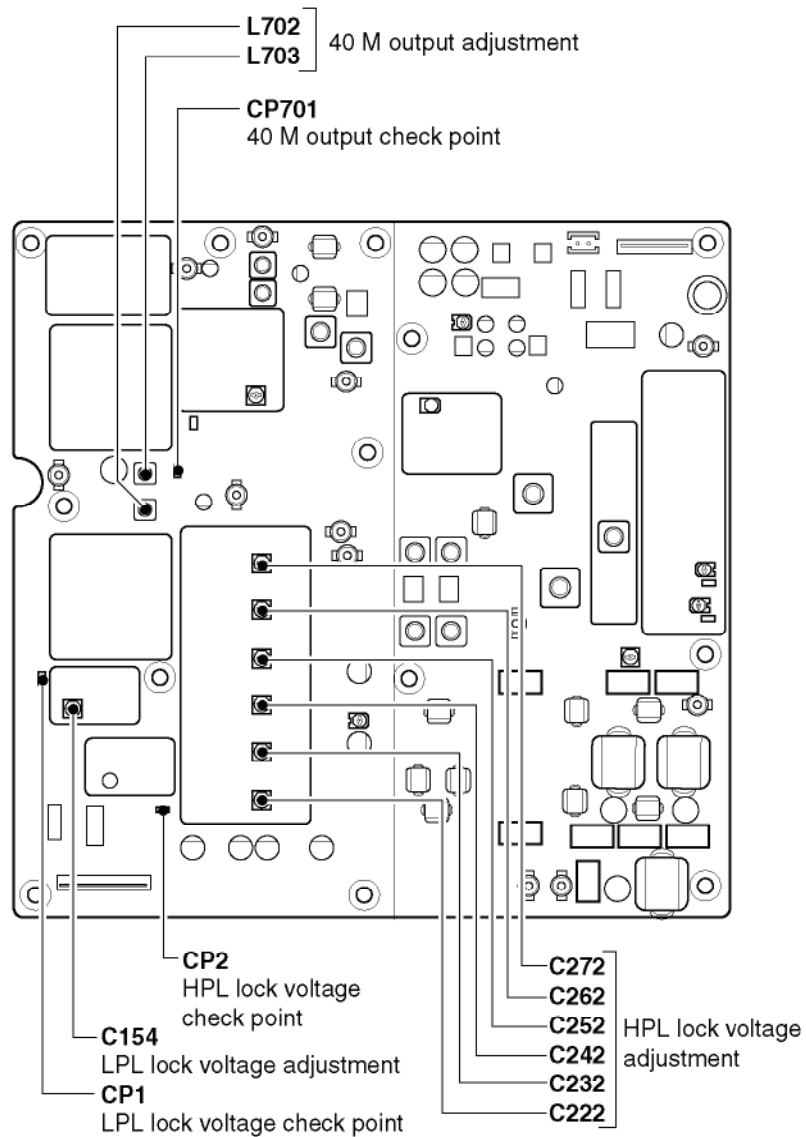
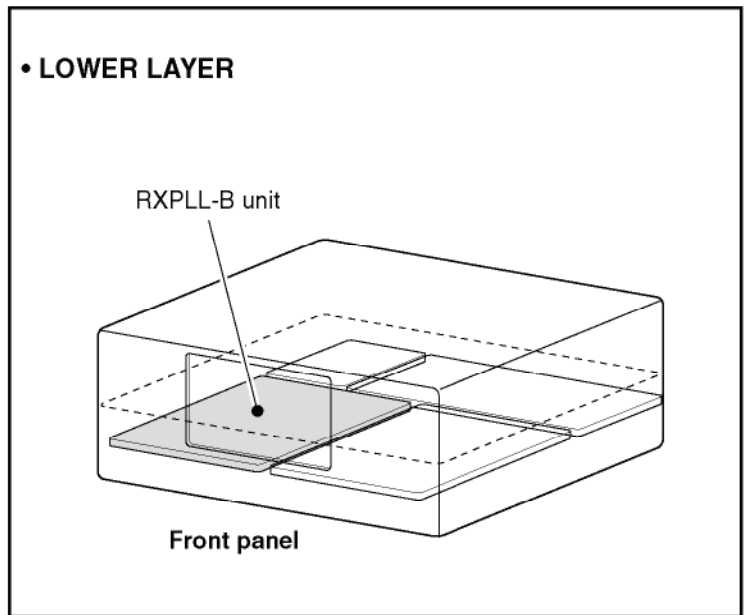

RXPLL-B UNIT ADJUSTMENTS—Continued

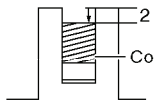
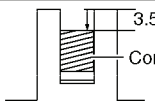
ADJUSTMENT	ADJUSTMENT CONDITION	MEASUREMENT		VALUE	ADJUSTMENT POINT	
		UNIT	LOCATION		UNIT	ADJUST
HPL LOCK VOLTAGE (VCO6)	12 <ul style="list-style-type: none"> • SUB display frequency : 45.000 MHz • Mode : USB • Receiving 	RX PLL-B	Connect a DC voltmeter to the CP2 (LV2).	1.8 V–2.8 V		Verify
S1 LO OUTPUT	1 <ul style="list-style-type: none"> • SUB display frequency : 14.999 MHz • Mode : USB • Receiving 	RX PLL-B	Connect an RF voltmeter to the J351 (S1LO).	2.25 dBm \pm 0.25 dB	RX PLL-B	R357
2LO LOCK VOLTAGE	1 <ul style="list-style-type: none"> • SUB display frequency : 14.100 MHz • Mode : USB • Receiving 	RX PLL-B	Connect a DC voltmeter to the CP3.	1.5 V \pm 0.3 V	RX PLL-B	C546
2LO OUTPUT	1 <ul style="list-style-type: none"> • MAIN display frequency : 14.100 MHz • Mode : USB • Receiving 	RX PLL-B	Connect a spectrum analyzer to the J561 (2LO).	Maximum level (–9.0 dBm \pm 3.0 dB)	RX PLL-B	L565, L566
	2 Repeat the above adjustment sometimes.					
RX SENSITIVITY	1 <ul style="list-style-type: none"> Pre-set the IC-7800 as below condition. • SUB display frequency : 14.150 MHz • Mode : USB • Dual watch : ON • MAIN Ant. : ANT2 • SUB Ant. : ANT1 • Pre-amp. 1 : ON • MAIN AF : Minimum level • Receiving 	RX PLL-B	Connect a DC voltmeter to the CP1102.	4.5 V \pm 0.1 V	RX PLL-B	R1101
			Connect a DC voltmeter to the CP1103.	4.5 V \pm 0.1 V	RX PLL-B	R1132
				Center position		R1228
				2 rotations	Core	L1401 L1402
				3.5 rotations	Core	L1403 L1404
(HF)	2 <ul style="list-style-type: none"> • SUB display frequency : 14.150 MHz • Mode : USB • Connect an SSG to [ANT1] connector and set as : Frequency : 14.1515 MHz Level : 1 μV* (–107 dBm) Modulation: OFF • Receiving 	Rear panel	Connect an AC millivolt meter to the [EXT SP] jack with 8 Ω load.	Maximum audio level	RX PLL-B	L1408, L1058
IMAGE RESPONSE	1 <ul style="list-style-type: none"> • SUB display frequency : 14.150 MHz • Mode : USB • Connect an SSG to [ANT1] connector and set as : Frequency : 14.0765 MHz Level : 50 mV* (–13 dBm) Modulation: OFF • Receiving 	Rear panel	Connect a AC millivoltmeter to the [EXT SP] jack with 8 Ω load.	Minimum image	RX PLL-B	R1516, C1656
	2 Repeat the above adjustment sometimes.					

*This output level of a standard signal generator (SSG) is indicated as SSG's open circuit.

• RXPLL-B UNIT TOP VIEW

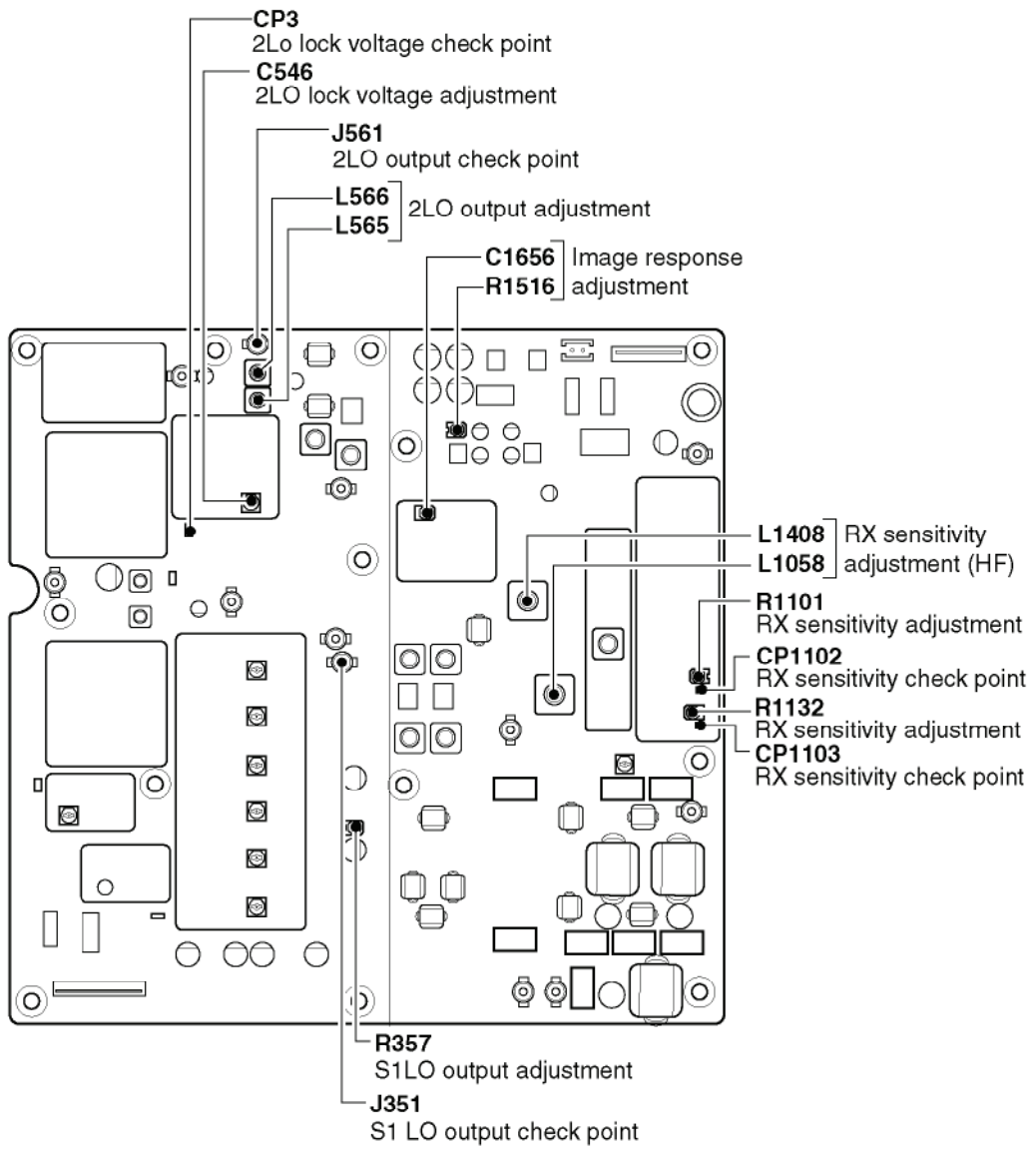
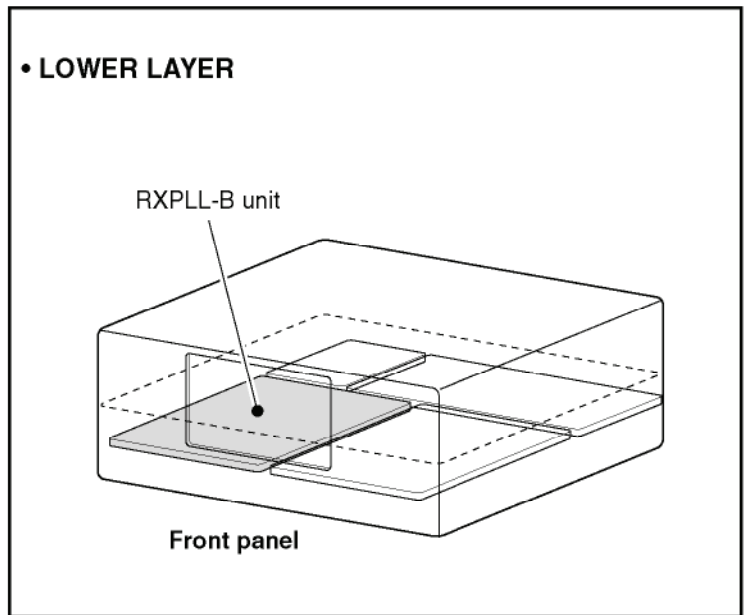

RXPLL-B UNIT ADJUSTMENTS—Continued

ADJUSTMENT	ADJUSTMENT CONDITION	MEASUREMENT		VALUE	ADJUSTMENT POINT	
		UNIT	LOCATION		UNIT	ADJUST
RX SENSITIVITY (50 MHz)	1 <ul style="list-style-type: none"> • SUB display frequency : 50.020 MHz • Mode : USB • Pre-amp. 2 : ON • Connect an SSG to [ANT1] connector and set as : <ul style="list-style-type: none"> Frequency : 50.0215 MHz Level : 0.32 μV[*] (-117 dBm) Modulation: OFF • Receiving 	Rear panel	Connect an AC millivolt meter to the [EXT SP] jack with 8 Ω load.	Maximum audio level	RX PLL-B	L1222
IF THROUGH (50 MHz)	1 <ul style="list-style-type: none"> • SUB display frequency : 50.020 MHz • Mode : USB • Connect an SSG to [ANT1] connector and set as : <ul style="list-style-type: none"> Frequency : 64.455 MHz Level : 50 mV[*] (-13 dBm) Modulation: OFF • Receiving 	Front panel	S-meter	Minimum level	RX PLL-B	C1265

*This output level of a standard signal generator (SSG) is indicated as SSG's open circuit.

• RXPLL-B UNIT TOP VIEW

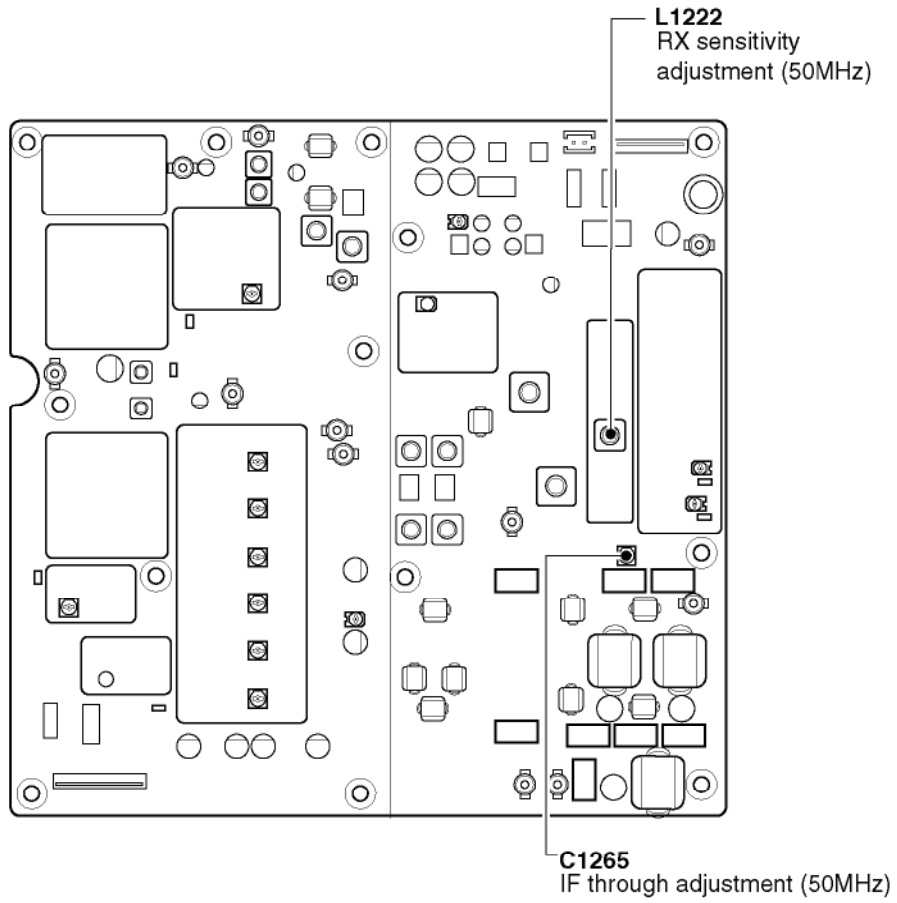
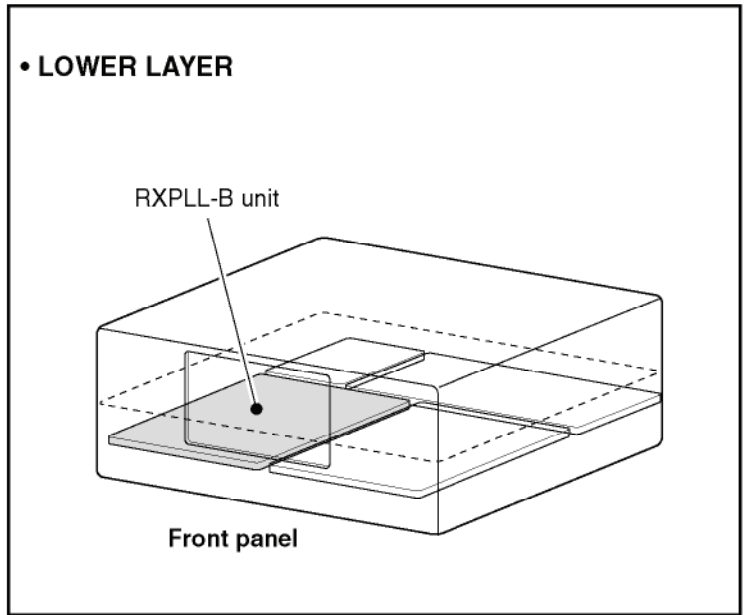

4-5 PA200W BOARD ADJUSTMENTS

ADJUSTMENT		ADJUSTMENT CONDITION	MEASUREMENT		VALUE	ADJUSTMENT POINT			
			UNIT	LOCATION		UNIT	ADJUST		
IDLING CURRENT (For driver)	1	<ul style="list-style-type: none"> • Preset R301, R407, R410 on the PA200W unit to max. CCW*. • [MIC] gain : max. CCW* • Main display frequency : 14.100 MHz • Mode : USB • Apply no audio signals to the [MIC] connector. • Transmitting 	PA200W	Connect an ammeter between W1 and the transceiver.	1.0 A higher	PA200W	R301		
	(For final amplifier)	2					<ul style="list-style-type: none"> • Transmitting 	1.0 A higher	R407 R425
		3					<ul style="list-style-type: none"> • Transmitting 	1.0 A higher	R410 R426

*CCW: Counter clockwise

• PA200W BOARD TOP VIEW

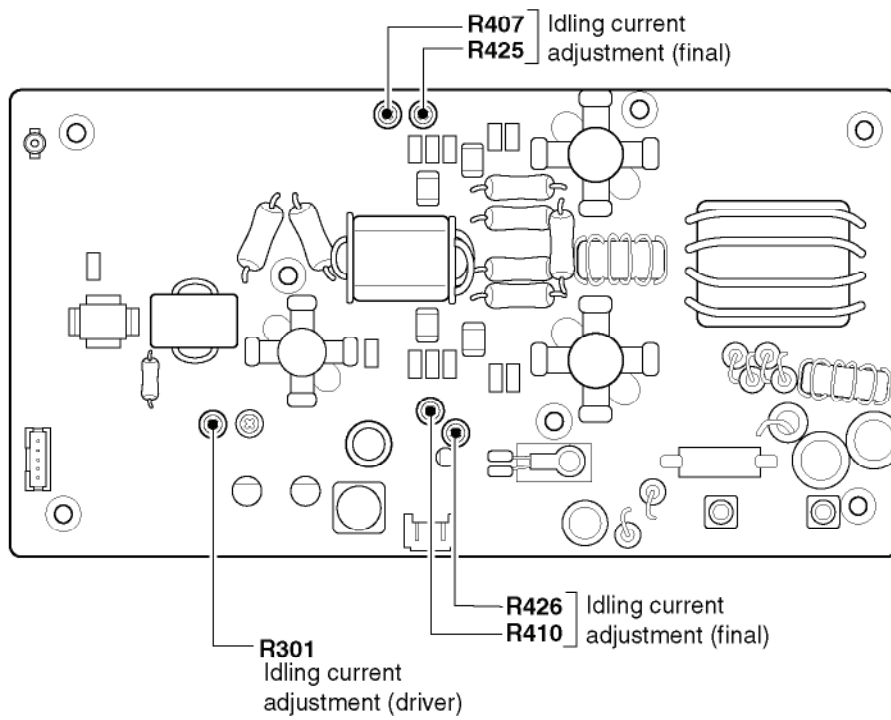
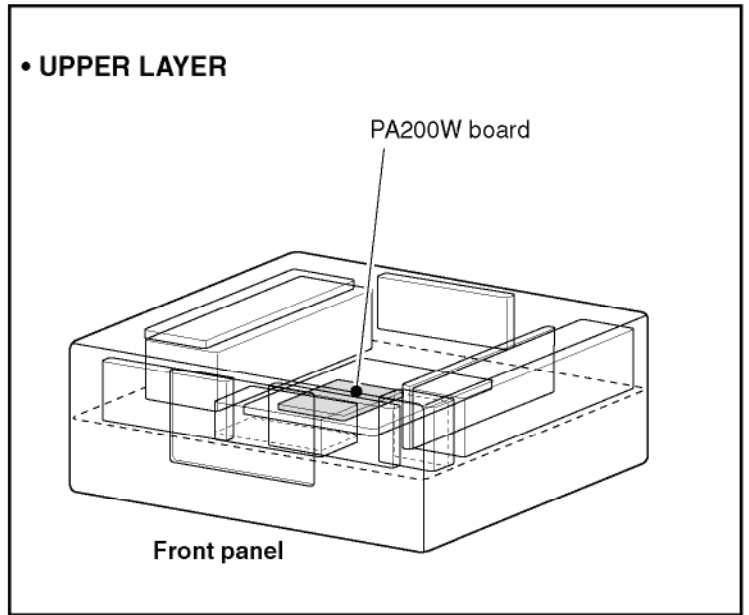

4-6 TUNER ADJUSTMENT

ADJUSTMENT	ADJUSTMENT CONDITION	MEASUREMENT		VALUE	ADJUSTMENT POINT		
		UNIT	LOCATION		UNIT	ADJUST	
SWR DETECTOR	1	<ul style="list-style-type: none"> • Main display frequency : 24.950 MHz • Mode : FM • [RF POWER] : Max. CW (200W) • [TUNER] : Through • APC : OFF • Connect a 50 Ω terminator to [ANT1] connector. • Transmitting 	CTRL	Connect a digital multimeter or oscilloscope to the check point CP101 (REF).	Minimum voltage	CTRL	C104
		ADJUSTMENT CONDITION	DISPLAY		OPERATION		
TUNER REFERENCE	1	<ul style="list-style-type: none"> • Enter the tuner adjustment mode: <ol style="list-style-type: none"> ① Turn power OFF. ② Terminate the [REMOTE] jack with a 2-conductor 3.5(d) mm mini-plug. ③ While pushing [M.SCOPE] and [EXIT/SET], turn power ON. 	TUNER-ADJUST MODE		Push [F-7 (START)] to start tuning.		
	2		-- TUNER -- Adjusting Now		Verify the display shows "Adjusting Now".		
	3		-- TUNER -- OK		Verify the display shows "OK".		

• CTRL BOARD TOP VIEW

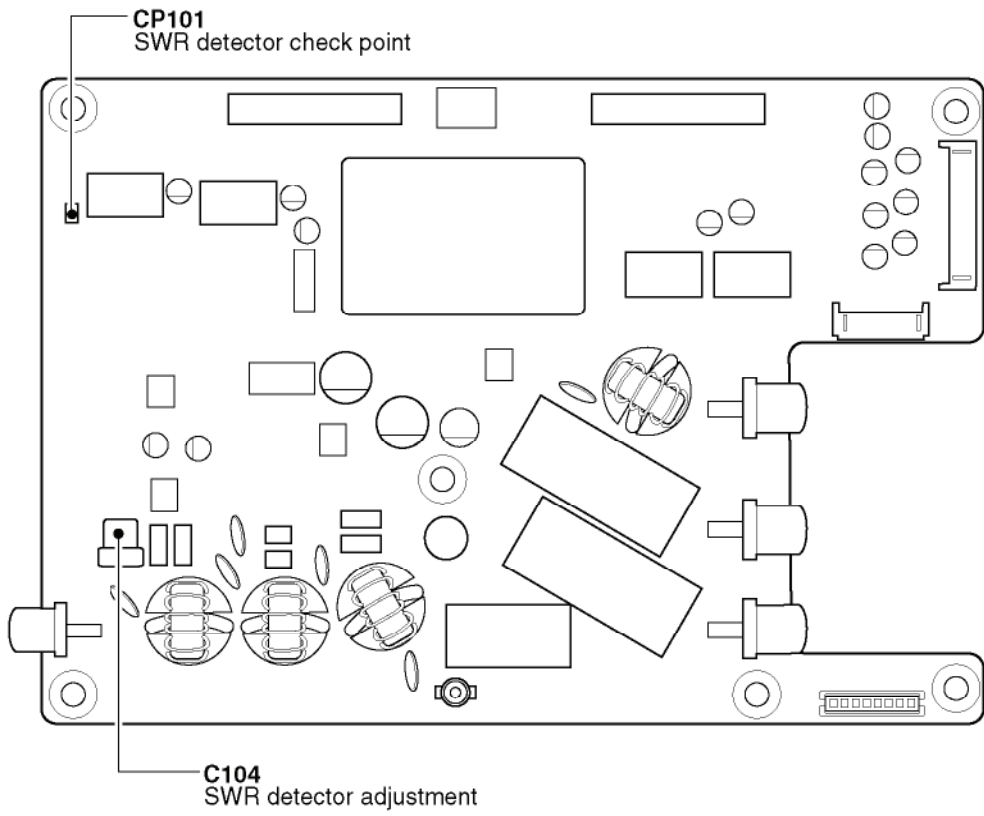
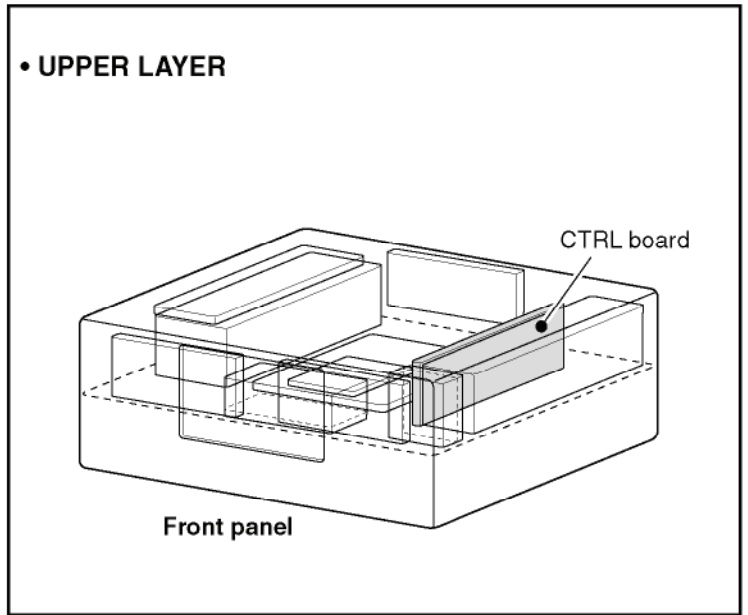

4-7 MAIN UNIT ADJUSTMENTS

ADJUSTMENT	ADJUSTMENT CONDITION	MEASUREMENT		VALUE	ADJUSTMENT POINT	
		UNIT	LOCATION		UNIT	ADJUST
MAXIMUM OUTPUT POWER	1 <ul style="list-style-type: none"> • Turn the power OFF • Push and hold [F-INP] and [MW], and then turn the power ON. • Preset R93 to 3 o'clock position. 	MAIN	Connect a digital multimeter or oscilloscope to the check point CP82.	0.5 V \pm 0.2 V	MAIN	R69
	2 <ul style="list-style-type: none"> • Connect an audio generator to the [MIC] connector and set as: Frequency : 1.5 kHz Level : 1 mV • Transmitting 	Rear panel	Connect an RF power meter to the [ANT1] connector.	Maximum output power	MAIN	L505 C576 L512
RESIDUAL AM	3 <ul style="list-style-type: none"> • Mode : FM • Connect an audio generator to the [MIC] connector and set as: Frequency : 1.0 kHz Level : 10 mV • Transmitting 	Rear panel	Connect an RF power meter to the [ANT1] connector.	Minimum level difference between an audio generator is ON and OFF.	MAIN	verify
	4 <ul style="list-style-type: none"> • Apply no audio signals to the [MIC] connector. • Transmitting 					C576
TX TOTAL GAIN	1 <ul style="list-style-type: none"> • MAIN display frequency : Any • Mode : USB • [MIC] GAIN : 12 o'clock position • Connect an audio generator to the [MIC] connector and set as: Frequency : 1.5 kHz Level : 1 mV • Transmitting 	Rear panel	Connect an RF power meter to the [ANT1] connector.	130 W	MAIN	R538
HIGH POWER (HF)	1 <ul style="list-style-type: none"> • MAIN display frequency : 14.100 MHz • Mode : RTTY • Transmitting 	Rear panel	Connect an RF power meter to the [ANT1] connector.	200 W	MAIN	R81
(50 MHz)	2 <ul style="list-style-type: none"> • MAIN display frequency : 50.100 MHz • Mode : RTTY • Transmitting 			200 W		R79
AM CARRIER POWER	1 <ul style="list-style-type: none"> • MAIN display frequency : 14.100 MHz • Mode : AM • Apply no audio signals to the [MIC] connector. • Transmitting 	Rear panel	Connect an RF power meter to the [ANT1] connector.	55 W	MAIN	R82
Id-APC	1 <ul style="list-style-type: none"> • MAIN display frequency : 14.100 MHz • Mode : RTTY • Connect CP81 to GND. • Preset R93 to 90° CCW*. • Transmitting 	PA	Connect an ammeter between the PA unit and the W1.	12 A	MAIN	R93

*CCW: Counter clockwise

• MAIN UNIT TOP VIEW

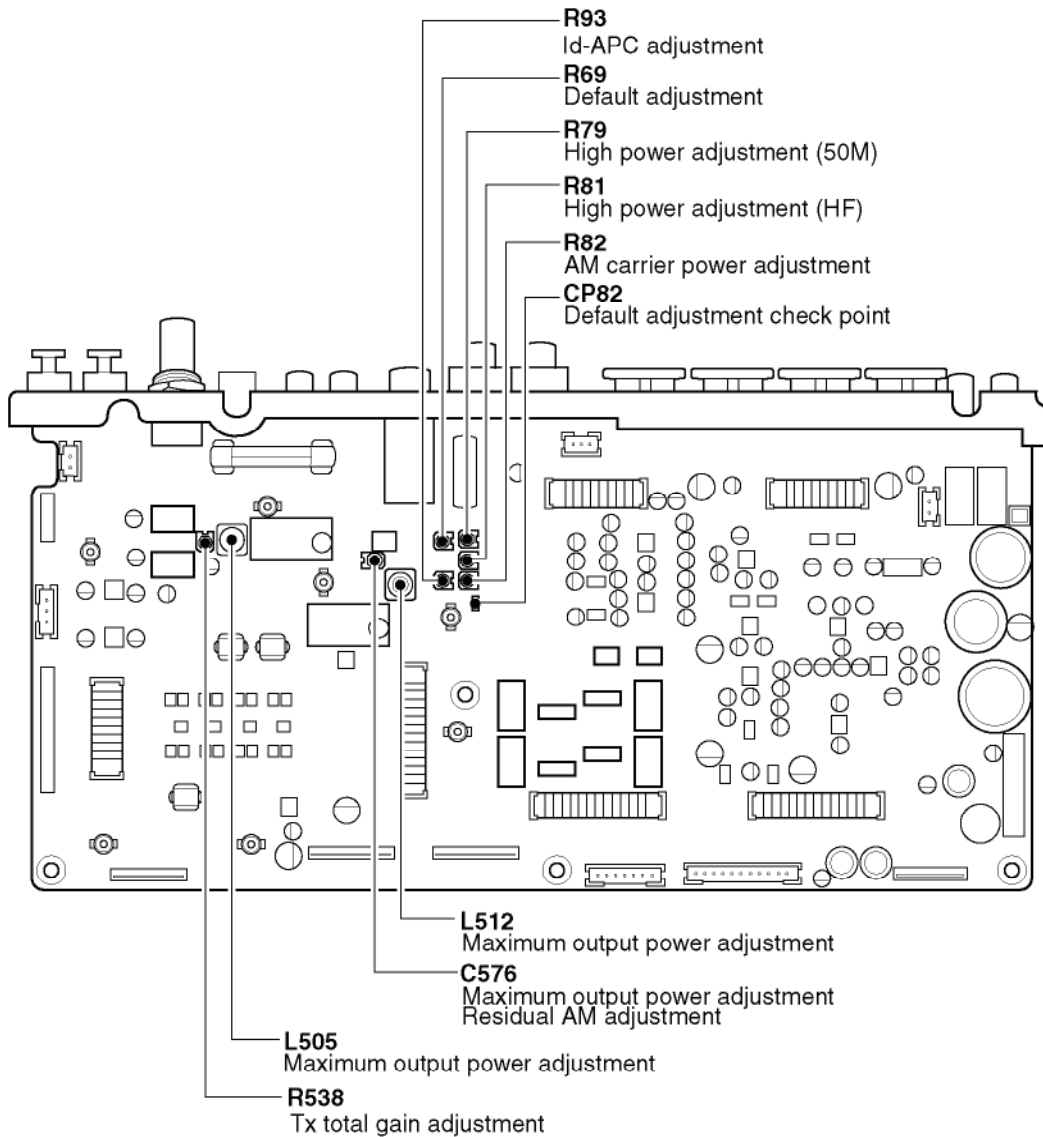
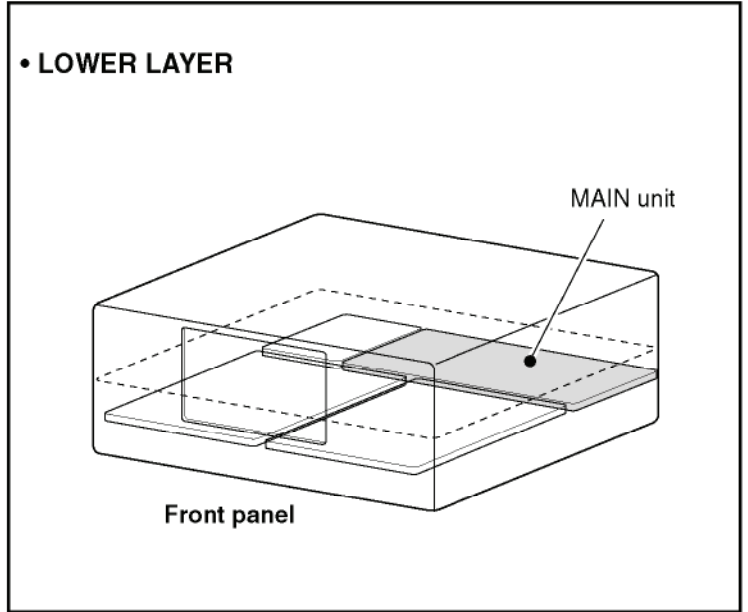

4-8 SCOPE UNIT ADJUSTMENTS

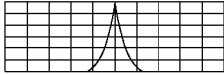
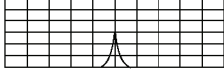
ADJUSTMENT	ADJUSTMENT CONDITION	MEASUREMENT		VALUE	ADJUSTMENT POINT		
		UNIT	LOCATION		UNIT	ADJUST	
S3 LO LOCK VOLTAGE	1 Pre-set the IC-7800 as below condition. <ul style="list-style-type: none"> • Dualwatch : OFF • Pre-amp. : OFF • Attenuator : OFF • Scope : ON • Scope attenuator: OFF • MAIN display frequency : 14.200 MHz • Mode : CW • Span : ± 25 kHz • Receiving 	SCOPE	Connect a digital voltmeter to the CP801.	2.5 V	SCOPE	C824	
SCOPE	1 • Connect an SSG to the [ANT1] connector and set as : Frequency : 14.200 MHz Level : 500 μ V* (-53 dBm) Modulation: OFF • Receiving	Front panel	Scope wave on the LCD.	Maximum wave form	SCOPE	L203 L202 L201 L5 L6 C41	
	2 Repeat the above adjustment L5, L6 and C41 sometimes.			Minimum wave form			C41
	3 • Connect an SSG to J1 and set as: Frequency : 71.715 MHz Level : 100 mV* (-7 dBm) Modulation: OFF • Receiving			Maximum wave form			L5 L6
	4 • Set an SSG as: Frequency : 14.200 MHz Level : 500 μ V* (-53 dBm) Modulation: OFF • Receiving						
SCOPE GAIN	1 • MAIN display frequency : 14.200 MHz • Mode : CW • Connect an SSG to J1 and set as: Frequency : 14.200 MHz Level : 500 μ V* (-53 dBm) Modulation: OFF • Receiving	Front panel	Scope wave on the LCD.	Set peak of scope wave form to 6 scales on the LCD.	SCOPE	R416	
							
SCOPE ATTENUATOR	1 • MAIN display frequency : 14.200 MHz • Mode : CW • Scope attenuator: 30 dB • Connect an SSG to J1 and set as: Frequency : 14.200 MHz Level : 500 μ V* (-53 dBm) Modulation: OFF • Receiving	Front panel	Scope wave on the LCD.	Set peak of scope wave form to 3 scales on the LCD.	SCOPE	R11	
							

*This output level of a standard signal generator (SSG) is indicated as SSG's open circuit.

• SCOPE UNIT TOP VIEW

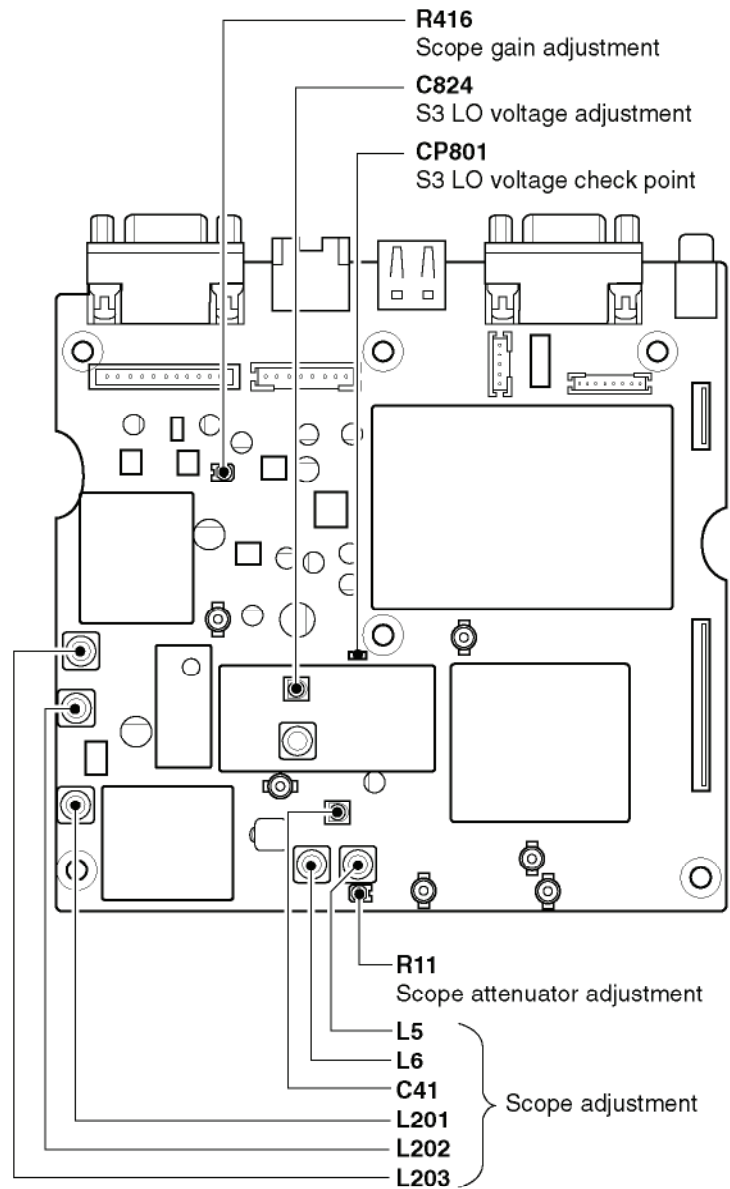
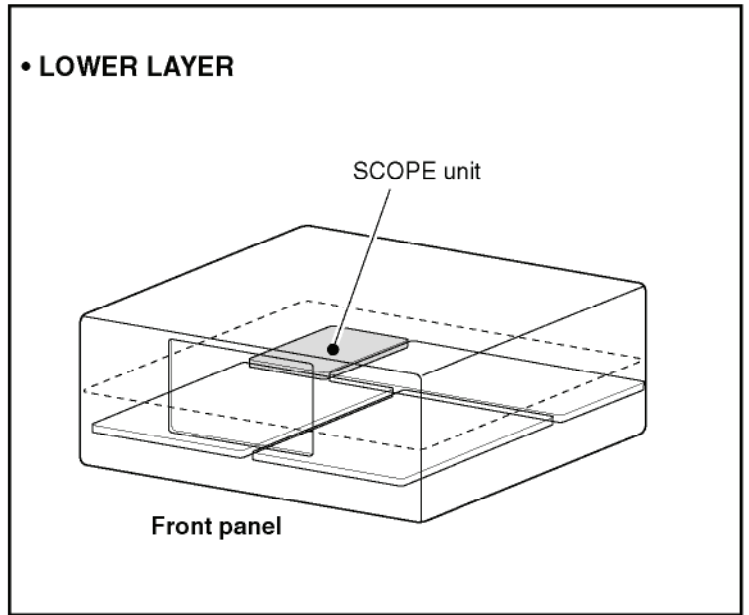

4-9 SOFTWARE ADJUSTMENTS

ADJUSTMENT	ADJUSTMENT CONDITION	DISPLAY	OPERATION
ENTERING ADJUSTMENT MODE	1	ADJUST MODE	<p>Push [F-1 (METER)], [F-2 (RX)] or [F-3 (TX)] to select each adjustment mode.</p> <p>Once entering adjustment mode, use [F-1 (▼)] to skip items, or [F-2 (EXIT)] to return the opening display.</p>
	<ul style="list-style-type: none"> Enter the adjustment mode: <ol style="list-style-type: none"> Turn power OFF. Terminate the [REMOTE] jack with a 2-conductor 3.5(d) mm mini-plug. While pushing [SSB] and [CW/RTTY], turn power ON. 		
<p>CAUTION: NEVER select adjustment items [F-3 (TX)] while transceiver is connected to an SSG. Because transceiver automatically transmits when transmit item in the [F-3 (TX)] is selected.</p>			
HF PO METER	1	POWER HF/50M 0W	Push [F-7 (SET)] to store the "0 W" meter indication into memory, and move to the next step .
	2	POWER HF 10W	Rotate [MAIN DIAL] to set the RF output power become 10 W. Push [F-7 (SET)] to set 10 W power meter indication and selects the next adjustment item.
	3	POWER HF 50W	Rotate [MAIN DIAL] to set the RF output power become 50 W. Push [F-7 (SET)] to set 50 W power meter indication and selects the next adjustment item.
	4	POWER HF 100W	Rotate [MAIN DIAL] to set the RF output power become 100 W. Push [F-7 (SET)] to set 100 W power meter indication and selects the next adjustment item.
	5	POWER HF 150W	Rotate [MAIN DIAL] to set the RF output power become 150 W. Push [F-7 (SET)] to set 150 W power meter indication and selects the next adjustment item.
	6	POWER HF 200W	Rotate [MAIN DIAL] to set the RF output power become 195 W. Push [F-7 (SET)] to set 200 W power meter indication and selects the next adjustment item.
50 MHz PO METER	1	POWER 50M 10W	Rotate [MAIN DIAL] to set the RF output power become 10 W. Push [F-7 (SET)] to set 10 W power meter indication and selects the next adjustment item.
	2	POWER 50M 50W	Rotate [MAIN DIAL] to set the RF output power become 50 W. Push [F-7 (SET)] to set 50 W power meter indication and selects the next adjustment item.
	3	POWER 50M 100W	Rotate [MAIN DIAL] to set the RF output power become 100 W. Push [F-7 (SET)] to set 100 W power meter indication and selects the next adjustment item.
	4	POWER 50M 150W	Rotate [MAIN DIAL] to set the RF output power become 150 W. Push [F-7 (SET)] to set 150 W power meter indication and selects the next adjustment item.
	5	POWER 50M 200W	Rotate [MAIN DIAL] to set the RF output power become 195 W. Push [F-7 (SET)] to set 200 W power meter indication and selects the next adjustment item.
RESERVE POWER SET ^o	1	RESERVE POWER SET	Push [F-7 (SET)] to memorize the setting, and select the next adjustment item.
POWER SET (power down)	1	Power for Power Down HF/50M	Set the RF output power to 100 W with [MAIN DIAL]. Push [F-7 (SET)] to set the RF power level and selects the next adjustment item.
ALC METER	1	ALC	Push [F-7 (SET)] to set the ALC meter and selects the next adjustment item.

SOFTWARE ADJUSTMENTS—Continued

ADJUSTMENT	ADJUSTMENT CONDITION	DISPLAY	OPERATION
DRIVE LEVEL	1	DRIVE	Push [F-7 (SET)] to set the DRIVE level and selects the next adjustment item.
Vd METER	1	Vd48V	Push [F-7 (SET)] to set the Vd meter indication and selects the next adjustment item.
Id METER	1	Id 0A	Push [F-7 (SET)] to set the 0 A meter indication and selects the next adjustment item.
	2	Id 5A	Rotate [MAIN DIAL] to set the driving current become 5 A. Push [F-7 (SET)] to set the 5 A meter indication and selects the next adjustment item
	3	Id 10A	Rotate [MAIN DIAL] to set the driving current become 10 A. Push [F-7 (SET)] to set the 10 A meter indication and selects the next adjustment item
SWR METER		SWR	Push [F-7 (SET)] to set the SWR meter indication and selects the next adjustment item.
HF TOTAL GAIN	1	Total Gain A HF PRE OFF	Set the AF output level to 0 dB.
	2		Rotate [MAIN DIAL] to set the AF output level to -30 dB. Push [F-7 (SET)] to set the HF A total gain and selects the next adjustment item.
	3	Total Gain A HF PRE ON	Rotate [MAIN DIAL] to set the AF output level to -30 dB. Push [F-7 (SET)] to set the HF A total gain and selects the next adjustment item.
	4	Total Gain A 50M PRE OFF	Rotate [MAIN DIAL] to set the AF output level to -30 dB. Push [F-7 (SET)] to set the 50 MHz A total gain and selects the next adjustment item.
	5	Total Gain A 50M PRE ON	Rotate [MAIN DIAL] to set the AF output level to -30 dB. Push [F-7 (SET)] to set the 50 MHz A total gain and selects the next adjustment item.
	6	Total Gain B HF PRE OFF	Set the AF output level to 0 dB.
	7		Rotate [MAIN DIAL] to set the AF output level to -30 dB. Push [F-7 (SET)] to set the HF B total gain and selects the next adjustment item.
	8	Total Gain B HF PRE ON	Rotate [MAIN DIAL] to set the AF output level to -30 dB. Push [F-7 (SET)] to set the HF B total gain and selects the next adjustment item.
	9	Total Gain B 50M PRE OFF	Rotate [MAIN DIAL] to set the AF output level to -30 dB. Push [F-7 (SET)] to set the 50 MHz B total gain and selects the next adjustment item.
	10	Total Gain B 50M PRE ON	Rotate [MAIN DIAL] to set the AF output level to -30 dB. Push [F-7 (SET)] to set the 50 MHz B total gain and selects the next adjustment item.

*This output level of a standard signal generator (SSG) is indicated as SSG's open circuit.

SOFTWARE ADJUSTMENTS—Continued

ADJUSTMENT	ADJUSTMENT CONDITION	DISPLAY	OPERATION
EXTERNAL AGC	1 • Connect an SSG to the [ANT1] connector and set as: Frequency : 14.1515 MHz Level : 3.2 mV* (-37 dBm) Modulation : OFF	AGC(RX-DSP)A	Push [F-7 (SET)] to set the external AGC level and selects the next adjustment item.
	2	AGC(RX-DSP)B	Push [F-7 (SET)] to set the external AGC level and selects the next adjustment item.
HF S-METER	1 • Set the SSG as: Level : OFF	HF S0 LEVEL	<ul style="list-style-type: none"> • Push [F-7 (SET)] to set the HF S0 meter indication and selects the next adjustment item. • Never change the SSG output level until 2 short beeps are sound.
	2 • Set the SSG as: Level : 50 μ V* (-73 dBm)	HF S9 LEVEL	<ul style="list-style-type: none"> • Push [F-7 (SET)] to set the HF S9 meter indication and selects the next adjustment item. • Never change the SSG output level until 2 short beeps are sound.
	3 • Set the SSG as: Level : 50 mV* (-13 dBm)	S9+60 LEVEL	<ul style="list-style-type: none"> • Push [F-7 (SET)] to set the HF S9+60 meter indication and selects the next adjustment item. • Never change the SSG output level until 2 short beeps are sound.
50 MHz S-METER	1 • Set the SSG as: Level : OFF	50M S0 LEVEL	<ul style="list-style-type: none"> • Push [F-7 (SET)] to set the 50 MHz S0 meter indication and selects the next adjustment item. • Never change the SSG output level until 2 short beeps are sound.
	2 • Set the SSG as: Level : 50 μ V* (-73 dBm)	50M S9 LEVEL	<ul style="list-style-type: none"> • Push [F-7 (SET)] to set the 50MHz S9 meter indication and selects the next adjustment item. • Never change the SSG output level until 2 short beeps are sound.
	3 • Set the SSG as: Level : 50 mV* (-13 dBm)	S9+60 LEVEL	<ul style="list-style-type: none"> • Push [F-7 (SET)] to set the 50 MHz S9+60 meter indication and selects the next adjustment item. • Never change the SSG output level until 2 short beeps are sound.
REFERENCE FREQUENCY	1 • Connect a frequency counter to the MAIN unit, J490. <div style="border: 1px solid black; padding: 2px; width: fit-content;"> <p>NOTE: This adjustment need to adjust after more than 5 minutes past since IC-7800 is power ON.</p> </div>	REF OSC	Rotate [MAIN DIAL] to set the reference frequency to 10.0000000 MHz. Push [F-7 (SET)] to set the frequency and return to the initial screen.

*This output level of a standard signal generator (SSG) is indicated as SSG's open circuit.

SECTION 5 PARTS LIST

[FRONT UNIT]

REF NO.	ORDER NO.	DESCRIPTION		M.
W1	8900008940	CABLE	OPC-886 (P=1 N=10 L=75)	
W2	8900008940	CABLE	OPC-886 (P=1 N=10 L=75)	
W3	8900012870	CABLE	OPC-1331 (N=40,L=70)	
W4	8900008670	CABLE	OPC-849 (N:30 L:70)	
W5	8900008940	CABLE	OPC-886 (P=1 N=10 L=75)	
W6	8900008940	CABLE	OPC-886 (P=1 N=10 L=75)	
W7	8900012880	CABLE	OPC-1336 (N=18,L=70)	
W8	8900008940	CABLE	OPC-886 (P=1 N=10 L=75)	
W9	8900012890	CABLE	OPC-1332 (N=40,L=100)	
W10	8900006990	CABLE	OPC-683 (N:10 L:110)	
W11	8900008670	CABLE	OPC-849 (N:30 L:70)	
W12	8900008670	CABLE	OPC-849 (N:30 L:70)	
W13	8900008940	CABLE	OPC-886 (P=1 N=10 L=75)	
W14	8900008670	CABLE	OPC-849 (N:30 L:70)	
W15	8900008940	CABLE	OPC-886 (P=1 N=10 L=75)	
W51	8600037050		SX2590 P51*P52FR	
EP1	6910015290	UNIT BOARD	EDTCB23QAF	
EP11	6910011090	SENSOR UNIT	RMS20-250-201-P	
EP12	6910011090	SENSOR UNIT	RMS20-250-201-P	
EP13	0880001460	UNIT BOARD	EX-2500 #03	
EP101	6910015650	E.OTHER	S-G2218-3#01 (MOUNT PLATE)	
EP102	6910015650	E.OTHER	S-G2218-3#01 (MOUNT PLATE)	

[VR-A BOARD]

REF NO.	ORDER NO.	DESCRIPTION		M.
R1	7210002890	VARIABLE	RK161221005J/RV-308	T
R2	7210002890	VARIABLE	RK161221005J/RV-308	T
R3	7210002890	VARIABLE	RK161221005J/RV-308	T
R4	7210002890	VARIABLE	RK161221005J/RV-308	T
R11	7030003520	S.RESISTOR	ERJ3GEYJ 472 V (4.7 kΩ)	B
R12	7030003520	S.RESISTOR	ERJ3GEYJ 472 V (4.7 kΩ)	B
R13	7030003520	S.RESISTOR	ERJ3GEYJ 472 V (4.7 kΩ)	B
R14	7030003520	S.RESISTOR	ERJ3GEYJ 472 V (4.7 kΩ)	B
R15	7030003520	S.RESISTOR	ERJ3GEYJ 472 V (4.7 kΩ)	B
R16	7030003520	S.RESISTOR	ERJ3GEYJ 472 V (4.7 kΩ)	B
R17	7030003520	S.RESISTOR	ERJ3GEYJ 472 V (4.7 kΩ)	B
R18	7030003520	S.RESISTOR	ERJ3GEYJ 472 V (4.7 kΩ)	B
R21	7030003860	S.RESISTOR	ERJ3GE JPW V	B
R22	7030003860	S.RESISTOR	ERJ3GE JPW V	B
R23	7030003860	S.RESISTOR	ERJ3GE JPW V	B
R24	7030003860	S.RESISTOR	ERJ3GE JPW V	B
R25	7030003860	S.RESISTOR	ERJ3GE JPW V	B
R26	7030003860	S.RESISTOR	ERJ3GE JPW V	B
C11	4030006880	S.CERAMIC	C1608 JB 1H 472K-T	B
C12	4030006880	S.CERAMIC	C1608 JB 1H 472K-T	B
C13	4030006880	S.CERAMIC	C1608 JB 1H 472K-T	B
C14	4030006880	S.CERAMIC	C1608 JB 1H 472K-T	B
C15	4030006880	S.CERAMIC	C1608 JB 1H 472K-T	B
C16	4030006880	S.CERAMIC	C1608 JB 1H 472K-T	B
C17	4030006880	S.CERAMIC	C1608 JB 1H 472K-T	B
C18	4030006880	S.CERAMIC	C1608 JB 1H 472K-T	B
J1	6510021720	S.CONNECTOR	30FLT-SM1-TB	B
J2	6510018920	S.CONNECTOR	B8B-PH-SM3-TB	B
J3	6510019970	S.CONNECTOR	52808-1091	B
J4	6510019970	S.CONNECTOR	52808-1091	B
EP1	0910057493	PCB	B 5951C	B
EP2	6910012350	PCB	MMZ1608Y 102BT	B
EP3	6910012350	PCB	MMZ1608Y 102BT	B
EP4	6910012350	PCB	MMZ1608Y 102BT	B
EP5	6910012350	PCB	MMZ1608Y 102BT	B
EP6	6910012350	PCB	MMZ1608Y 102BT	B
EP7	6910012350	PCB	MMZ1608Y 102BT	B
EP8	6910012350	PCB	MMZ1608Y 102BT	B
EP9	6910012350	PCB	MMZ1608Y 102BT	B
EP10	6910012350	PCB	MMZ1608Y 102BT	B

[VR-A BOARD]

REF NO.	ORDER NO.	DESCRIPTION		M.
EP11	6910012350	PCB	MMZ1608Y 102BT	B
EP12	6910012350	PCB	MMZ1608Y 102BT	B
EP13	6910012350	PCB	MMZ1608Y 102BT	B
EP14	6910012350	PCB	MMZ1608Y 102BT	B
EP15	6910012350	PCB	MMZ1608Y 102BT	B
EP16	6910012350	PCB	MMZ1608Y 102BT	B
EP17	6910012350	PCB	MMZ1608Y 102BT	B
EP18	6910012350	PCB	MMZ1608Y 102BT	B
EP19	6910012350	PCB	MMZ1608Y 102BT	B
EP20	6910012350	PCB	MMZ1608Y 102BT	B
EP21	6910012350	PCB	MMZ1608Y 102BT	B
EP22	6910012350	PCB	MMZ1608Y 102BT	B

[VR-B BOARD]

REF NO.	ORDER NO.	DESCRIPTION		M.
R1	7210003160	VARIABLE	RV-317 (RK0972210)	T
R2	7210003160	VARIABLE	RV-317 (RK0972210)	T
R3	7030003520	S.RESISTOR	ERJ3GEYJ 472 V (4.7 kΩ)	T
R4	7030003520	S.RESISTOR	ERJ3GEYJ 472 V (4.7 kΩ)	T
R5	7030003520	S.RESISTOR	ERJ3GEYJ 472 V (4.7 kΩ)	T
R6	7030003520	S.RESISTOR	ERJ3GEYJ 472 V (4.7 kΩ)	T
C1	4030006880	S.CERAMIC	C1608 JB 1H 472K-T	T
C2	4030006880	S.CERAMIC	C1608 JB 1H 472K-T	T
C3	4030006880	S.CERAMIC	C1608 JB 1H 472K-T	T
C4	4030006880	S.CERAMIC	C1608 JB 1H 472K-T	T
J1	6510019970	S.CONNECTOR	52808-1091	T
EP1	0910057502	PCB	B 5952B	

[VR-C BOARD]

REF NO.	ORDER NO.	DESCRIPTION		M.
VR-C				
R1	7210003160	VARIABLE	RV-317 (RK0972210)	T
R2	7210003160	VARIABLE	RV-317 (RK0972210)	T
R3	7030003520	S.RESISTOR	ERJ3GEYJ 472 V (4.7 kΩ)	T
R4	7030003520	S.RESISTOR	ERJ3GEYJ 472 V (4.7 kΩ)	T
R5	7030003520	S.RESISTOR	ERJ3GEYJ 472 V (4.7 kΩ)	T
R6	7030003520	S.RESISTOR	ERJ3GEYJ 472 V (4.7 kΩ)	T
C1	4030006880	S.CERAMIC	C1608 JB 1H 472K-T	T
C2	4030006880	S.CERAMIC	C1608 JB 1H 472K-T	T
C3	4030006880	S.CERAMIC	C1608 JB 1H 472K-T	T
C4	4030006880	S.CERAMIC	C1608 JB 1H 472K-T	T
J1	6510019970	S.CONNECTOR	52808-1091	T
EP1	0910057512	PCB	B 5953B	

M.=Mounted side (T: Mounted on the Top side, B: Mounted on the Bottom side)

S.=Surface mount

[VR-D BOARD]

REF NO.	ORDER NO.	DESCRIPTION		M.
R1	7210001130	VARIABLE	RK097111T005A (10KB)	T
R2	7210001130	VARIABLE	RK097111T005A (10KB)	T
R3	7210001130	VARIABLE	RK097111T005A (10KB)	T
R4	7210001130	VARIABLE	RK097111T005A (10KB)	T
R5	7210001130	VARIABLE	RK097111T005A (10KB)	T
R6	7210001130	VARIABLE	RK097111T005A (10KB)	T
R7	7210001130	VARIABLE	RK097111T005A (10KB)	T
R11	7030003520	S.RESISTOR	ERJ3GEYJ 472 V (4.7 kΩ)	B
R12	7030003520	S.RESISTOR	ERJ3GEYJ 472 V (4.7 kΩ)	B
R13	7030003520	S.RESISTOR	ERJ3GEYJ 472 V (4.7 kΩ)	B
R14	7030003520	S.RESISTOR	ERJ3GEYJ 472 V (4.7 kΩ)	B
R15	7030003520	S.RESISTOR	ERJ3GEYJ 472 V (4.7 kΩ)	B
R16	7030003520	S.RESISTOR	ERJ3GEYJ 472 V (4.7 kΩ)	B
R17	7030003520	S.RESISTOR	ERJ3GEYJ 472 V (4.7 kΩ)	B
C11	4030006880	S.CERAMIC	C1608 JB 1H 472K-T	B
C12	4030006880	S.CERAMIC	C1608 JB 1H 472K-T	B
C13	4030006880	S.CERAMIC	C1608 JB 1H 472K-T	B
C14	4030006880	S.CERAMIC	C1608 JB 1H 472K-T	B
C15	4030006880	S.CERAMIC	C1608 JB 1H 472K-T	B
C16	4030006880	S.CERAMIC	C1608 JB 1H 472K-T	B
C17	4030006880	S.CERAMIC	C1608 JB 1H 472K-T	B
J1	6510019970	S.CONNECTOR	52808-1091	B
EP1	0910057522	PCB	B 5954B	

[SW-A BOARD]

REF NO.	ORDER NO.	DESCRIPTION		M.
DS7	5040002930	S.LED	SML-512MW T86P	T
DS8	5040002930	S.LED	SML-512MW T86P	T
DS9	5040002930	S.LED	SML-512MW T86P	T
DS10	5040002930	S.LED	SML-512MW T86P	T
DS11	5040002930	S.LED	SML-512MW T86P	T
DS12	5040002930	S.LED	SML-512MW T86P	T
DS13	5040002930	S.LED	SML-512MW T86P	T
DS14	5040002930	S.LED	SML-512MW T86P	T
DS15	5040002990	S.LED	SML-512UWT86	T
DS16	5040002930	S.LED	SML-512MW T86P	T
DS17	5040002930	S.LED	SML-512MW T86P	T
S1	2260002740	S.SWITCH	LS8J2M-T	T
S2	2260002740	S.SWITCH	LS8J2M-T	T
S3	2260002740	S.SWITCH	LS8J2M-T	T
S4	2260002740	S.SWITCH	LS8J2M-T	T
S5	2260002740	S.SWITCH	LS8J2M-T	T
S6	2260002740	S.SWITCH	LS8J2M-T	T
S7	2260002740	S.SWITCH	LS8J2M-T	T
S8	2260002740	S.SWITCH	LS8J2M-T	T
S11	2260002740	S.SWITCH	LS8J2M-T	T
S12	2260002740	S.SWITCH	LS8J2M-T	T
S13	2260002740	S.SWITCH	LS8J2M-T	T
S14	2260002740	S.SWITCH	LS8J2M-T	T
S15	2260002740	S.SWITCH	LS8J2M-T	T
S16	2260002740	S.SWITCH	LS8J2M-T	T
S17	2260002740	S.SWITCH	LS8J2M-T	T
S18	2260002740	S.SWITCH	LS8J2M-T	T
S19	2260002740	S.SWITCH	LS8J2M-T	T
S20	2260002740	S.SWITCH	LS8J2M-T	T
S21	2260002740	S.SWITCH	LS8J2M-T	T
EP1	0910057443	PCB	B 5955C	

[SW-A BOARD]

REF NO.	ORDER NO.	DESCRIPTION		M.
R2	7030003400	S.RESISTOR	ERJ3GEYJ 471 V (470 Ω)	B
R3	7030003420	S.RESISTOR	ERJ3GEYJ 681 V (680 Ω)	B
R4	7030003400	S.RESISTOR	ERJ3GEYJ 471 V (470 Ω)	B
R6	7030003400	S.RESISTOR	ERJ3GEYJ 471 V (470 Ω)	B
R7	7030003400	S.RESISTOR	ERJ3GEYJ 471 V (470 Ω)	B
R8	7030003400	S.RESISTOR	ERJ3GEYJ 471 V (470 Ω)	B
R9	7030003400	S.RESISTOR	ERJ3GEYJ 471 V (470 Ω)	B
R10	7030003400	S.RESISTOR	ERJ3GEYJ 471 V (470 Ω)	B
R11	7030003400	S.RESISTOR	ERJ3GEYJ 471 V (470 Ω)	B
R12	7030003400	S.RESISTOR	ERJ3GEYJ 471 V (470 Ω)	B
R13	7030003480	S.RESISTOR	ERJ3GEYJ 222 V (2.2 kΩ)	B
R14	7030003520	S.RESISTOR	ERJ3GEYJ 472 V (4.7 kΩ)	B
R15	7030003480	S.RESISTOR	ERJ3GEYJ 222 V (2.2 kΩ)	B
R16	7030003520	S.RESISTOR	ERJ3GEYJ 472 V (4.7 kΩ)	B
R17	7030003480	S.RESISTOR	ERJ3GEYJ 222 V (2.2 kΩ)	B
R18	7030003520	S.RESISTOR	ERJ3GEYJ 472 V (4.7 kΩ)	B
R19	7030003540	S.RESISTOR	ERJ3GEYJ 682 V (6.8 kΩ)	B
R20	7030003540	S.RESISTOR	ERJ3GEYJ 682 V (6.8 kΩ)	B
R21	7030003540	S.RESISTOR	ERJ3GEYJ 682 V (6.8 kΩ)	B
R22	7030003480	S.RESISTOR	ERJ3GEYJ 222 V (2.2 kΩ)	B
R23	7030003520	S.RESISTOR	ERJ3GEYJ 472 V (4.7 kΩ)	B
R24	7030003580	S.RESISTOR	ERJ3GEYJ 153 V (15 kΩ)	B
R25	7030003480	S.RESISTOR	ERJ3GEYJ 222 V (2.2 kΩ)	B
R26	7030003520	S.RESISTOR	ERJ3GEYJ 472 V (4.7 kΩ)	B
R27	7030003540	S.RESISTOR	ERJ3GEYJ 682 V (6.8 kΩ)	B
R28	7030003540	S.RESISTOR	ERJ3GEYJ 682 V (6.8 kΩ)	B
R29	7030003580	S.RESISTOR	ERJ3GEYJ 153 V (15 kΩ)	B
R30	7030003400	S.RESISTOR	ERJ3GEYJ 471 V (470 Ω)	B
C1	4030011600	S.CERAMIC	C1608 JB 1E 104K-T	B
C2	4030011600	S.CERAMIC	C1608 JB 1E 104K-T	B
C3	4030011600	S.CERAMIC	C1608 JB 1E 104K-T	B
C4	4030011600	S.CERAMIC	C1608 JB 1E 104K-T	B
C5	4030011600	S.CERAMIC	C1608 JB 1E 104K-T	B
C6	4030011600	S.CERAMIC	C1608 JB 1E 104K-T	B
C7	4030011600	S.CERAMIC	C1608 JB 1E 104K-T	B
C8	4030011600	S.CERAMIC	C1608 JB 1E 104K-T	B
C9	4030011600	S.CERAMIC	C1608 JB 1E 104K-T	B
J1	6510019970	S.CONNECTOR	52808-1091	B
J2	6510019970	S.CONNECTOR	52808-1091	B
J3	6510022470	S.CONNECTOR	40FLT-SM1-TB	B
DS5	5040002980	S.LED	SML-512DW-T86	T
DS6	5040002930	S.LED	SML-512MW T86P	T

[SW-B BOARD]

REF NO.	ORDER NO.	DESCRIPTION		M.
J1	6510020530	S.CONNECTOR	52808-1891	B
S1	2260002740	S.SWITCH	LS8J2M-T	T
S2	2260002740	S.SWITCH	LS8J2M-T	T
S3	2260002740	S.SWITCH	LS8J2M-T	T
S4	2260002740	S.SWITCH	LS8J2M-T	T
S5	2260002740	S.SWITCH	LS8J2M-T	T
S6	2260002740	S.SWITCH	LS8J2M-T	T
S7	2260002740	S.SWITCH	LS8J2M-T	T
S8	2260002740	S.SWITCH	LS8J2M-T	T
S9	2260002740	S.SWITCH	LS8J2M-T	T
S10	2260002740	S.SWITCH	LS8J2M-T	T
S11	2260002740	S.SWITCH	LS8J2M-T	T
S12	2260002740	S.SWITCH	LS8J2M-T	T
S13	2260002740	S.SWITCH	LS8J2M-T	T
S14	2260002740	S.SWITCH	LS8J2M-T	T
S15	2260002740	S.SWITCH	LS8J2M-T	T
S16	2260002740	S.SWITCH	LS8J2M-T	T
S17	2260002740	S.SWITCH	LS8J2M-T	T
EP1	0910057452	PCB	B 5956B	

M.-Mounted side (T: Mounted on the Top side, B: Mounted on the Bottom side)

S.-Surface mount

[SW-C BOARD]

REF NO.	ORDER NO.	DESCRIPTION		M.
R1	7030003480	S.RESISTOR	ERJ3GEYJ 222 V (2.2 kΩ)	B
R2	7030003520	S.RESISTOR	ERJ3GEYJ 472 V (4.7 kΩ)	B
R3	7030003580	S.RESISTOR	ERJ3GEYJ 153 V (15 kΩ)	B
R4	7030003540	S.RESISTOR	ERJ3GEYJ 682 V (6.8 kΩ)	B
R5	7030003480	S.RESISTOR	ERJ3GEYJ 222 V (2.2 kΩ)	B
R6	7030003520	S.RESISTOR	ERJ3GEYJ 472 V (4.7 kΩ)	B
R7	7030003580	S.RESISTOR	ERJ3GEYJ 153 V (15 kΩ)	B
R8	7030003540	S.RESISTOR	ERJ3GEYJ 682 V (6.8 kΩ)	B
R9	7030003480	S.RESISTOR	ERJ3GEYJ 222 V (2.2 kΩ)	B
R10	7030003520	S.RESISTOR	ERJ3GEYJ 472 V (4.7 kΩ)	B
R11	7030003580	S.RESISTOR	ERJ3GEYJ 153 V (15 kΩ)	B
R12	7030003540	S.RESISTOR	ERJ3GEYJ 682 V (6.8 kΩ)	B
R13	7030003480	S.RESISTOR	ERJ3GEYJ 222 V (2.2 kΩ)	B
R14	7030003520	S.RESISTOR	ERJ3GEYJ 472 V (4.7 kΩ)	B
R15	7030003540	S.RESISTOR	ERJ3GEYJ 682 V (6.8 kΩ)	B
R51	7030003400	S.RESISTOR	ERJ3GEYJ 471 V (470 Ω)	B
R52	7030003400	S.RESISTOR	ERJ3GEYJ 471 V (470 Ω)	B
R53	7030003400	S.RESISTOR	ERJ3GEYJ 471 V (470 Ω)	B
R54	7030003400	S.RESISTOR	ERJ3GEYJ 471 V (470 Ω)	B
R55	7030003400	S.RESISTOR	ERJ3GEYJ 471 V (470 Ω)	B
R56	7030003400	S.RESISTOR	ERJ3GEYJ 471 V (470 Ω)	B
R57	7030003400	S.RESISTOR	ERJ3GEYJ 471 V (470 Ω)	B
R58	7030003400	S.RESISTOR	ERJ3GEYJ 471 V (470 Ω)	B
C1	4030011600	S.CERAMIC	C1608 JB 1E 104K-T	B
C2	4030011600	S.CERAMIC	C1608 JB 1E 104K-T	B
C3	4030011600	S.CERAMIC	C1608 JB 1E 104K-T	B
C4	4030011600	S.CERAMIC	C1608 JB 1E 104K-T	B
J1	6510021720	S.CONNECTOR	30FLT-SM1-TB	B
J2	6510019970	S.CONNECTOR	52808-1091	B
DS51	5040002930	S.LED	SML-512MW T86P	T
DS52	5040002930	S.LED	SML-512MW T86P	T
DS53	5040002930	S.LED	SML-512MW T86P	T
DS54	5040002930	S.LED	SML-512MW T86P	T
DS55	5040002930	S.LED	SML-512MW T86P	T
DS56	5040002930	S.LED	SML-512MW T86P	T
DS57	5040002930	S.LED	SML-512MW T86P	T
DS58	5040002930	S.LED	SML-512MW T86P	T
S1	2260002740	S.SWITCH	LS8J2M-T	T
S2	2260002740	S.SWITCH	LS8J2M-T	T
S3	2260002740	S.SWITCH	LS8J2M-T	T
S4	2260002740	S.SWITCH	LS8J2M-T	T
S5	2260002740	S.SWITCH	LS8J2M-T	T
S6	2260002740	S.SWITCH	LS8J2M-T	T
S7	2260002740	S.SWITCH	LS8J2M-T	T
S8	2260002740	S.SWITCH	LS8J2M-T	T
S9	2260002740	S.SWITCH	LS8J2M-T	T
S10	2260002740	S.SWITCH	LS8J2M-T	T
S11	2260002740	S.SWITCH	LS8J2M-T	T
S12	2260002740	S.SWITCH	LS8J2M-T	T
S13	2260002740	S.SWITCH	LS8J2M-T	T
S14	2260002740	S.SWITCH	LS8J2M-T	T
S15	2260002740	S.SWITCH	LS8J2M-T	T
S16	2260002740	S.SWITCH	LS8J2M-T	T
S17	2260002740	S.SWITCH	LS8J2M-T	T
S18	2260002740	S.SWITCH	LS8J2M-T	T
S19	2260002740	S.SWITCH	LS8J2M-T	T
S20	2260002740	S.SWITCH	LS8J2M-T	T
S21	2260002740	S.SWITCH	LS8J2M-T	T
S22	2260002740	S.SWITCH	LS8J2M-T	T
EP1	0910057462	PCB	B 5957B	

[JACK BOARD]

REF NO.	ORDER NO.	DESCRIPTION		M.
L1	6200003950	S.COIL	HF50ACC 322513-T	B
L2	6200003950	S.COIL	HF50ACC 322513-T	B
L3	6200003950	S.COIL	HF50ACC 322513-T	B
R1	7030006060	S.RESISTOR	ERJ12YJ100U (10 Ω)	T
R2	7030006060	S.RESISTOR	ERJ12YJ100U (10 Ω)	T

[JACK BOARD]

REF NO.	ORDER NO.	DESCRIPTION		M.
C1	4030006880	S.CERAMIC	C1608 JB 1H 472K-T	B
C2	4030006880	S.CERAMIC	C1608 JB 1H 472K-T	B
C3	4030006880	S.CERAMIC	C1608 JB 1H 472K-T	B
C101	4030006880	S.CERAMIC	C1608 JB 1H 472K-T	B
C102	4030006880	S.CERAMIC	C1608 JB 1H 472K-T	B
J1	6510019970	S.CONNECTOR	52808-1091	B
J2	6510023890	CONNECTOR	S-G4617#01	B
J102	6510023900	CONNECTOR	LGR4619-7000	B
EP1	0910057472	PCB	B 5959B	
EP101	6910012350	S.BEAD	MMZ1608Y 102BT	B
EP102	6910012350	S.BEAD	MMZ1608Y 102BT	B

[MIC BOARD]

REF NO.	ORDER NO.	DESCRIPTION		M.
MIC				
L1	6200003260	S.COIL	NL 322522T-101J	B
L2	6200003260	S.COIL	NL 322522T-101J	B
L3	6200003260	S.COIL	NL 322522T-101J	B
L4	6200003950	S.COIL	HF50ACC 322513-T	B
C1	4030006880	S.CERAMIC	C1608 JB 1H 472K-T	B
C2	4030006880	S.CERAMIC	C1608 JB 1H 472K-T	B
C3	4030006880	S.CERAMIC	C1608 JB 1H 472K-T	B
C4	4030007130	S.CERAMIC	C1608 CH 1H 101J-T	B
C5	4030006880	S.CERAMIC	C1608 JB 1H 472K-T	B
C6	4030006880	S.CERAMIC	C1608 JB 1H 472K-T	B
C7	4030006880	S.CERAMIC	C1608 JB 1H 472K-T	B
J1	6510000190	CONNECTOR	FM214-8SS (P)	T
J2	6510019970	S.CONNECTOR	52808-1091	B
EP1	0910057533	PCB	B 5960C	B
EP2	6910012350	S.BEAD	MMZ1608Y 102BT	B
EP3	6910012350	S.BEAD	MMZ1608Y 102BT	B
EP4	6910012350	S.BEAD	MMZ1608Y 102BT	B
EP5	6910012350	S.BEAD	MMZ1608Y 102BT	B
EP6	6910012350	S.BEAD	MMZ1608Y 102BT	B
EP7	6910015130	S.BEAD	MMZ1608D 301BT	B
EP8	6910015130	S.BEAD	MMZ1608D 301BT	B
EP9	6910015130	S.BEAD	MMZ1608D 301BT	B
EP10	6910015130	S.BEAD	MMZ1608D 301BT	B
EP11	6910015130	S.BEAD	MMZ1608D 301BT	B

[TENKEY BOARD]

REF NO.	ORDER NO.	DESCRIPTION		M.
IC1	1130011510	S.IC	BU2099FV-E2	B
IC2	1130011510	S.IC	BU2099FV-E2	B
R1	7030003480	S.RESISTOR	ERJ3GEYJ 222 V (2.2 kΩ)	B
R2	7030003520	S.RESISTOR	ERJ3GEYJ 472 V (4.7 kΩ)	B
R3	7030003580	S.RESISTOR	ERJ3GEYJ 153 V (15 kΩ)	B
R4	7030003540	S.RESISTOR	ERJ3GEYJ 682 V (6.8 kΩ)	B
R5	7030003480	S.RESISTOR	ERJ3GEYJ 222 V (2.2 kΩ)	B
R6	7030003520	S.RESISTOR	ERJ3GEYJ 472 V (4.7 kΩ)	B
R7	7030003580	S.RESISTOR	ERJ3GEYJ 153 V (15 kΩ)	B
R8	7030003540	S.RESISTOR	ERJ3GEYJ 682 V (6.8 kΩ)	B
R9	7030003480	S.RESISTOR	ERJ3GEYJ 222 V (2.2 kΩ)	B
R10	7030003520	S.RESISTOR	ERJ3GEYJ 472 V (4.7 kΩ)	B
R11	7030003580	S.RESISTOR	ERJ3GEYJ 153 V (15 kΩ)	B
R12	7030003540	S.RESISTOR	ERJ3GEYJ 682 V (6.8 kΩ)	B
R51	7030003390	S.RESISTOR	ERJ3GEYJ 391 V (390 Ω)	B
R52	7030003390	S.RESISTOR	ERJ3GEYJ 391 V (390 Ω)	B
R53	7030003390	S.RESISTOR	ERJ3GEYJ 391 V (390 Ω)	B
R54	7030003390	S.RESISTOR	ERJ3GEYJ 391 V (390 Ω)	B

M.-Mounted side (T: Mounted on the Top side, B: Mounted on the Bottom side)

S.-Surface mount

[TENKEY BOARD]

REF NO.	ORDER NO.	DESCRIPTION		M.
R55	7030003390	S.RESISTOR	ERJ3GEYJ 391 V (390 Ω)	B
R56	7030003390	S.RESISTOR	ERJ3GEYJ 391 V (390 Ω)	B
R57	7030003390	S.RESISTOR	ERJ3GEYJ 391 V (390 Ω)	B
R58	7030003390	S.RESISTOR	ERJ3GEYJ 391 V (390 Ω)	B
R59	7030003390	S.RESISTOR	ERJ3GEYJ 391 V (390 Ω)	B
R60	7030003390	S.RESISTOR	ERJ3GEYJ 391 V (390 Ω)	B
R61	7030003390	S.RESISTOR	ERJ3GEYJ 391 V (390 Ω)	B
R62	7030003390	S.RESISTOR	ERJ3GEYJ 391 V (390 Ω)	B
R63	7030003390	S.RESISTOR	ERJ3GEYJ 391 V (390 Ω)	B
R64	7030003390	S.RESISTOR	ERJ3GEYJ 391 V (390 Ω)	B
R65	7030003390	S.RESISTOR	ERJ3GEYJ 391 V (390 Ω)	B
R66	7030003390	S.RESISTOR	ERJ3GEYJ 391 V (390 Ω)	B
R67	7030003390	S.RESISTOR	ERJ3GEYJ 391 V (390 Ω)	B
R68	7030003390	S.RESISTOR	ERJ3GEYJ 391 V (390 Ω)	B
R69	7030003390	S.RESISTOR	ERJ3GEYJ 391 V (390 Ω)	B
R70	7030003390	S.RESISTOR	ERJ3GEYJ 391 V (390 Ω)	B
R71	7030003390	S.RESISTOR	ERJ3GEYJ 391 V (390 Ω)	B
R72	7030003390	S.RESISTOR	ERJ3GEYJ 391 V (390 Ω)	B
R73	7030003390	S.RESISTOR	ERJ3GEYJ 391 V (390 Ω)	B
R74	7030003390	S.RESISTOR	ERJ3GEYJ 391 V (390 Ω)	B
R75	7030003460	S.RESISTOR	ERJ3GEYJ 152 V (1.5 kΩ)	B
R76	7030003460	S.RESISTOR	ERJ3GEYJ 152 V (1.5 kΩ)	B
C1	4030011600	S.CERAMIC	C1608 JB 1E 104K-T	B
C2	4030011600	S.CERAMIC	C1608 JB 1E 104K-T	B
C3	4030011600	S.CERAMIC	C1608 JB 1E 104K-T	B
C4	4030011600	S.CERAMIC	C1608 JB 1E 104K-T	B
C5	4030011600	S.CERAMIC	C1608 JB 1E 104K-T	B
J1	6510021720	S.CONNECTOR	30FLT-SM1-TB	B
J2	6510021720	S.CONNECTOR	30FLT-SM1-TB	B
J3	6510021720	S.CONNECTOR	30FLT-SM1-TB	B
J4	6510019970	S.CONNECTOR	52808-1091	B
J5	6510019970	S.CONNECTOR	52808-1091	B
J6	6510003400	CONNECTOR	B04B-EH-S	B
J7	6510018970	S.CONNECTOR	B4B-PH-SM3-TB	B
DS1	5040002980	S.LED	SML-512DW-T86	T
DS2	5040002980	S.LED	SML-512DW-T86	T
S1	2260002740	S.SWITCH	LS8J2M-T	T
S2	2260002740	S.SWITCH	LS8J2M-T	T
S3	2260002740	S.SWITCH	LS8J2M-T	T
S4	2260002740	S.SWITCH	LS8J2M-T	T
S5	2260002740	S.SWITCH	LS8J2M-T	T
S6	2260002740	S.SWITCH	LS8J2M-T	T
S7	2260002740	S.SWITCH	LS8J2M-T	T
S8	2260002740	S.SWITCH	LS8J2M-T	T
S9	2260002740	S.SWITCH	LS8J2M-T	T
S11	2260002820	S.SWITCH	LS9J2M-2D/D-T	T
S12	2260002820	S.SWITCH	LS9J2M-2D/D-T	T
S13	2260002820	S.SWITCH	LS9J2M-2D/D-T	T
S14	2260002820	S.SWITCH	LS9J2M-2D/D-T	T
S15	2260002820	S.SWITCH	LS9J2M-2D/D-T	T
S16	2260002820	S.SWITCH	LS9J2M-2D/D-T	T
S17	2260002820	S.SWITCH	LS9J2M-2D/D-T	T
S18	2260002820	S.SWITCH	LS9J2M-2D/D-T	T
S19	2260002820	S.SWITCH	LS9J2M-2D/D-T	T
S20	2260002820	S.SWITCH	LS9J2M-2D/D-T	T
S21	2260002820	S.SWITCH	LS9J2M-2D/D-T	T
S22	2260002820	S.SWITCH	LS9J2M-2D/D-T	T
S23	2260002740	S.SWITCH	LS8J2M-T	T
S24	2260002740	S.SWITCH	LS8J2M-T	T
EP1	0910057543	PCB	B 5961C	

[PBT1 BOARD]

REF NO.	ORDER NO.	DESCRIPTION		M.
R1	7210003180	VARIABLE	RV-319 (RK0972210)	T
R2	7030003520	S.RESISTOR	ERJ3GEYJ 472 V (4.7 kΩ)	T
R3	7030003520	S.RESISTOR	ERJ3GEYJ 472 V (4.7 kΩ)	T
C1	4030006880	S.CERAMIC	C1608 JB 1H 472K-T	T
C2	4030006880	S.CERAMIC	C1608 JB 1H 472K-T	T
J1	6510019970	S.CONNECTOR	52808-1091	T
S1	2250000410	ENCODER	TP90D96E20-30F-2178-1	T
EP1	0910057552	PCB	B 5962B	

[PBT2 BOARD]

REF NO.	ORDER NO.	DESCRIPTION		M.
R1	7210003180	VARIABLE	RV-319 (RK0972210)	T
R2	7210003170	VARIABLE	RV-318 (RK09L1120CON)	T
R3	7030003520	S.RESISTOR	ERJ3GEYJ 472 V (4.7 kΩ)	T
R4	7030003520	S.RESISTOR	ERJ3GEYJ 472 V (4.7 kΩ)	T
R5	7030003520	S.RESISTOR	ERJ3GEYJ 472 V (4.7 kΩ)	T
C1	4030006880	S.CERAMIC	C1608 JB 1H 472K-T	T
C2	4030006880	S.CERAMIC	C1608 JB 1H 472K-T	T
C3	4030006880	S.CERAMIC	C1608 JB 1H 472K-T	T
J1	6510019970	S.CONNECTOR	52808-1091	T
S1	2250000410	ENCODER	TP90D96E20-30F-2178-1	T
EP1	0910057562	PCB	B 5963B	

[LED BOARD]

REF NO.	ORDER NO.	DESCRIPTION		M.
R1	7030003470	S.RESISTOR	ERJ3GEYJ 182 V (1.8 kΩ)	T
R2	7030003420	S.RESISTOR	ERJ3GEYJ 681 V (680 Ω)	T
R3	7030003440	S.RESISTOR	ERJ3GEYJ 102 V (1 kΩ)	T
R4	7030003400	S.RESISTOR	ERJ3GEYJ 471 V (470 Ω)	T
R5	7030003470	S.RESISTOR	ERJ3GEYJ 182 V (1.8 kΩ)	T
R6	7030003420	S.RESISTOR	ERJ3GEYJ 681 V (680 Ω)	T
R7	7030003440	S.RESISTOR	ERJ3GEYJ 102 V (1 kΩ)	T
J1	6510020710	S.CONNECTOR	52793-1090	T
DS1	5040003000	S.LED	SML-A12UT-T86	T
DS2	5040002960	S.LED	SML-A12MT T86	T
DS3	5040003010	S.LED	SML-A12WT	T
DS4	5040002970	S.LED	CL-270WB-D-TS	T
DS5	5040003000	S.LED	SML-A12UT-T86	T
DS6	5040002960	S.LED	SML-A12MT T86	T
DS7	5040003010	S.LED	SML-A12WT	T
EP1	0910057483	PCB	B 5964C	

M.=Mounted side (T: Mounted on the Top side, B: Mounted on the Bottom side)

S.=Surface mount

[CF BOARD]

REF NO.	ORDER NO.	DESCRIPTION		M.
R1	7030003470	S.RESISTOR	ERJ3GEYJ 182 V (1.8 kΩ)	T
J1	6510024150	S.CONNECTOR	50FY-BMT-TB	T
J2	6510024210	S.CONNECTOR	31-5620-050-716-871	T
J3	6510021600	S.CONNECTOR	S2B-PH-SM3-TB	T
DS1	5040002990	S.LED	SML-512UWT86	T
EP2	6910015640	E.OTHER	30-5610-000-002-000	T
EP10	0910057572	PCB	B 5965B	T

[DISPLAY BOARD]

REF NO.	ORDER NO.	DESCRIPTION		M.
R209	7030003860	S.RESISTOR	ERJ3GE JPW V	T
R210	7030003860	S.RESISTOR	ERJ3GE JPW V	T
R212	7030003860	S.RESISTOR	ERJ3GEYJ 683 V (68 kΩ)	T
R213	7030003580	S.RESISTOR	ERJ3GEYJ 153 V (15 kΩ)	T
R214	7030003440	S.RESISTOR	ERJ3GEYJ 102 V (1 kΩ)	T
R215	7030003440	S.RESISTOR	ERJ3GEYJ 102 V (1 kΩ)	T
R216	7030003440	S.RESISTOR	ERJ3GEYJ 102 V (1 kΩ)	T
R217	7030003440	S.RESISTOR	ERJ3GEYJ 102 V (1 kΩ)	T
R218	7030003440	S.RESISTOR	ERJ3GEYJ 102 V (1 kΩ)	T
R219	7030003440	S.RESISTOR	ERJ3GEYJ 102 V (1 kΩ)	T
R220	7030003440	S.RESISTOR	ERJ3GEYJ 102 V (1 kΩ)	T
R221	7030003440	S.RESISTOR	ERJ3GEYJ 102 V (1 kΩ)	T
R222	7030003440	S.RESISTOR	ERJ3GEYJ 102 V (1 kΩ)	T
R223	7030003440	S.RESISTOR	ERJ3GEYJ 102 V (1 kΩ)	T
R224	7030003440	S.RESISTOR	ERJ3GEYJ 102 V (1 kΩ)	T
R225	7030003440	S.RESISTOR	ERJ3GEYJ 102 V (1 kΩ)	T
R226	7030003440	S.RESISTOR	ERJ3GEYJ 102 V (1 kΩ)	T
R227	7030003440	S.RESISTOR	ERJ3GEYJ 102 V (1 kΩ)	T
R228	7030003440	S.RESISTOR	ERJ3GEYJ 102 V (1 kΩ)	T
R229	7030003440	S.RESISTOR	ERJ3GEYJ 102 V (1 kΩ)	T
R230	7030003440	S.RESISTOR	ERJ3GEYJ 102 V (1 kΩ)	T
R232	7030003440	S.RESISTOR	ERJ3GEYJ 102 V (1 kΩ)	T
R233	7030003440	S.RESISTOR	ERJ3GEYJ 102 V (1 kΩ)	T
R234	7030003440	S.RESISTOR	ERJ3GEYJ 102 V (1 kΩ)	T
R235	7030003440	S.RESISTOR	ERJ3GEYJ 102 V (1 kΩ)	T
R236	7030003440	S.RESISTOR	ERJ3GEYJ 102 V (1 kΩ)	T
R237	7030003440	S.RESISTOR	ERJ3GEYJ 102 V (1 kΩ)	T
R238	7030003440	S.RESISTOR	ERJ3GEYJ 102 V (1 kΩ)	T
R239	7030003440	S.RESISTOR	ERJ3GEYJ 102 V (1 kΩ)	T
R240	7030003440	S.RESISTOR	ERJ3GEYJ 102 V (1 kΩ)	T
R241	7030003680	S.RESISTOR	ERJ3GEYJ 104 V (100 kΩ)	T
R242	7030003680	S.RESISTOR	ERJ3GEYJ 104 V (100 kΩ)	T
R246	7030003440	S.RESISTOR	ERJ3GEYJ 102 V (1 kΩ)	T
R247	7030003440	S.RESISTOR	ERJ3GEYJ 102 V (1 kΩ)	T
R248	7030003440	S.RESISTOR	ERJ3GEYJ 102 V (1 kΩ)	T
R249	7030003440	S.RESISTOR	ERJ3GEYJ 102 V (1 kΩ)	T
R250	7030003440	S.RESISTOR	ERJ3GEYJ 102 V (1 kΩ)	T
R251	7030003320	S.RESISTOR	ERJ3GEYJ 101 V (100 Ω)	T
R252	7030003440	S.RESISTOR	ERJ3GEYJ 102 V (1 kΩ)	T
R253	7030003440	S.RESISTOR	ERJ3GEYJ 102 V (1 kΩ)	T
R254	7030003680	S.RESISTOR	ERJ3GEYJ 104 V (100 kΩ)	T
R255	7030003640	S.RESISTOR	ERJ3GEYJ 473 V (47 kΩ)	T
R256	7030003640	S.RESISTOR	ERJ3GEYJ 473 V (47 kΩ)	T
R257	7030003670	S.RESISTOR	ERJ3GEYJ 823 V (82 kΩ)	T
R258	7030003670	S.RESISTOR	ERJ3GEYJ 823 V (82 kΩ)	T
R259	7030003440	S.RESISTOR	ERJ3GEYJ 102 V (1 kΩ)	T
R260	7030003440	S.RESISTOR	ERJ3GEYJ 102 V (1 kΩ)	T
R261	7030003440	S.RESISTOR	ERJ3GEYJ 102 V (1 kΩ)	T
R262	7030003440	S.RESISTOR	ERJ3GEYJ 102 V (1 kΩ)	T
R263	7030003440	S.RESISTOR	ERJ3GEYJ 102 V (1 kΩ)	T
R264	7030003440	S.RESISTOR	ERJ3GEYJ 102 V (1 kΩ)	T
R265	7030003440	S.RESISTOR	ERJ3GEYJ 102 V (1 kΩ)	T
R266	7030003440	S.RESISTOR	ERJ3GEYJ 102 V (1 kΩ)	T
R267	7030003440	S.RESISTOR	ERJ3GEYJ 102 V (1 kΩ)	T
R268	7030003440	S.RESISTOR	ERJ3GEYJ 102 V (1 kΩ)	T
R269	7030003440	S.RESISTOR	ERJ3GEYJ 102 V (1 kΩ)	T
R270	7030003440	S.RESISTOR	ERJ3GEYJ 102 V (1 kΩ)	T
R271	7030003440	S.RESISTOR	ERJ3GEYJ 102 V (1 kΩ)	T
R272	7030003440	S.RESISTOR	ERJ3GEYJ 102 V (1 kΩ)	T
R273	7030003440	S.RESISTOR	ERJ3GEYJ 102 V (1 kΩ)	T
R274	7030003440	S.RESISTOR	ERJ3GEYJ 102 V (1 kΩ)	T
R275	7030003440	S.RESISTOR	ERJ3GEYJ 102 V (1 kΩ)	T
R276	7030003440	S.RESISTOR	ERJ3GEYJ 102 V (1 kΩ)	T
R278	7030003440	S.RESISTOR	ERJ3GEYJ 102 V (1 kΩ)	T
R279	7030003440	S.RESISTOR	ERJ3GEYJ 102 V (1 kΩ)	T
R280	7030003440	S.RESISTOR	ERJ3GEYJ 102 V (1 kΩ)	T
R281	7030003440	S.RESISTOR	ERJ3GEYJ 102 V (1 kΩ)	T
R282	7030003440	S.RESISTOR	ERJ3GEYJ 102 V (1 kΩ)	T
R283	7030003440	S.RESISTOR	ERJ3GEYJ 102 V (1 kΩ)	T
R284	7030003520	S.RESISTOR	ERJ3GEYJ 472 V (4.7 kΩ)	T
R285	7030003440	S.RESISTOR	ERJ3GEYJ 102 V (1 kΩ)	T
R286	7030003440	S.RESISTOR	ERJ3GEYJ 102 V (1 kΩ)	T
R287	7030003440	S.RESISTOR	ERJ3GEYJ 102 V (1 kΩ)	T
R288	7030003440	S.RESISTOR	ERJ3GEYJ 102 V (1 kΩ)	T
R289	7030003440	S.RESISTOR	ERJ3GEYJ 102 V (1 kΩ)	T
R290	7030003440	S.RESISTOR	ERJ3GEYJ 102 V (1 kΩ)	T
R291	7030003440	S.RESISTOR	ERJ3GEYJ 102 V (1 kΩ)	T
R292	7030003440	S.RESISTOR	ERJ3GEYJ 102 V (1 kΩ)	T
R293	7030003440	S.RESISTOR	ERJ3GEYJ 102 V (1 kΩ)	T
R294	7030003440	S.RESISTOR	ERJ3GEYJ 102 V (1 kΩ)	T
R295	7030003440	S.RESISTOR	ERJ3GEYJ 102 V (1 kΩ)	T
R296	7030003440	S.RESISTOR	ERJ3GEYJ 102 V (1 kΩ)	T
R297	7030003440	S.RESISTOR	ERJ3GEYJ 102 V (1 kΩ)	T
R298	7030003440	S.RESISTOR	ERJ3GEYJ 102 V (1 kΩ)	T
R299	7030003440	S.RESISTOR	ERJ3GEYJ 102 V (1 kΩ)	T
R300	7030003440	S.RESISTOR	ERJ3GEYJ 102 V (1 kΩ)	T
R301	7030003440	S.RESISTOR	ERJ3GEYJ 102 V (1 kΩ)	T
R302	7030003560	S.RESISTOR	ERJ3GEYJ 103 V (10 kΩ)	T

[DISPLAY BOARD]

REF NO.	ORDER NO.	DESCRIPTION		M.
IC1	1130009640	S.IC	BU4051BCFV-E2	T
IC2	1130009640	S.IC	BU4051BCFV-E2	T
IC3	1130009640	S.IC	BU4051BCFV-E2	T
IC4	1130009640	S.IC	BU4051BCFV-E2	T
IC5	1130009640	S.IC	BU4051BCFV-E2	T
IC6	1140011820	S.IC	M30620FCMGP D5 (SX-2590D)	T
IC7	1130011510	S.IC	BU2099FV-E2	T
IC201	1130009300	S.IC	TC7SET08FU (TE85L)	T
IC202	1130009300	S.IC	TC7SET08FU (TE85L)	T
IC601	1130011550	S.IC	RX-4581NB	T
IC651	1110005820	S.IC	R3112N281A-TR	T
Q200	1590000430	S.TRANSISTOR	DTC144EUA T106	T
Q201	1530003300	S.TRANSISTOR	2SC3647S-TD	T
Q202	1530003300	S.TRANSISTOR	2SC3647S-TD	T
Q203	1530002060	S.TRANSISTOR	2SC4081 T106 R	T
Q204	1520000650	S.TRANSISTOR	2SB1201-S-TL	T
Q205	1590000680	S.TRANSISTOR	DTC114EUA T106	T
Q206	1590000680	S.TRANSISTOR	DTC114EUA T106	T
Q208	1590001330	S.TRANSISTOR	DTA114EUA T106	T
Q209	1520000650	S.TRANSISTOR	2SB1201-S-TL	T
Q210	1530002060	S.TRANSISTOR	2SC4081 T106 R	T
Q211	1590001330	S.TRANSISTOR	DTA114EUA T106	T
Q212	1590000680	S.TRANSISTOR	DTC114EUA T106	T
Q501	1590000680	S.TRANSISTOR	DTC114EUA T106	T
Q502	1590000680	S.TRANSISTOR	DTC114EUA T106	T
Q503	1590000680	S.TRANSISTOR	DTC114EUA T106	T
Q504	1590001330	S.TRANSISTOR	DTA114EUA T106	T
Q505	1590000680	S.TRANSISTOR	DTC114EUA T106	T
Q601	1510000500	S.TRANSISTOR	2SA1162-GR (TE85R)	T
D7	1750000520	S.DIODE	DAN222TL	T
D8	1160000140	S.DIODE	DAP222 TL	T
D9	1730002340	S.ZENER	MA8047-M (TX)	T
D10	1730002590	S.ZENER	MA8033-H (TX)	T
D11	1790001670	S.DIODE	RB706F-40T106	T
D12	1790001670	S.DIODE	RB706F-40T106	T
D601	1790001250	S.DIODE	MA2S111-(TX)	T
D602	1790001250	S.DIODE	MA2S111-(TX)	T
D603	1790001250	S.DIODE	MA2S111-(TX)	T
X1	6050009870	S.XTAL	CR-567 (9.8304 MHz)	T
L201	6200001830	S.COIL	NL 322522T-100J	T
L203	6200003950	S.COIL	HF50ACC 322513-T	T
L204	6200001830	S.COIL	NL 322522T-100J	T
L205	6200003950	S.COIL	HF50ACC 322513-T	T
L207	6200003950	S.COIL	HF50ACC 322513-T	T
L208	6200003950	S.COIL	HF50ACC 322513-T	T
L209	6200003950	S.COIL	HF50ACC 322513-T	T
L210	6190001190	S.COIL	D10F-A814AY-101K=P3	T
L211	6190001190	S.COIL	D10F-A814AY-101K=P3	T
L601	6200001830	S.COIL	NL 322522T-100J	T
R200	7030003440	S.RESISTOR	ERJ3GEYJ 102 V (1 kΩ)	T
R201	7030003470	S.RESISTOR	ERJ3GEYJ 182 V (1.8 kΩ)	T
R202	7030003470	S.RESISTOR	ERJ3GEYJ 182 V (1.8 kΩ)	T
R203	7030003800	S.RESISTOR	ERJ3GEYJ 105 V (1 MΩ)	T
R208	7030003360	S.RESISTOR	ERJ3GEYJ 221 V (220 Ω)	T

M.-Mounted side (T: Mounted on the Top side, B: Mounted on the Bottom side)

S.-Surface mount

[DISPLAY BOARD]

REF NO.	ORDER NO.	DESCRIPTION	M.
R303	7030003560	S.RESISTOR ERJ3GEYJ 103 V (10 kΩ)	T
R304	7030003560	S.RESISTOR ERJ3GEYJ 103 V (10 kΩ)	T
R305	7030003560	S.RESISTOR ERJ3GEYJ 103 V (10 kΩ)	T
R306	7030003560	S.RESISTOR ERJ3GEYJ 103 V (10 kΩ)	T
R307	7030003560	S.RESISTOR ERJ3GEYJ 103 V (10 kΩ)	T
R308	7030003560	S.RESISTOR ERJ3GEYJ 103 V (10 kΩ)	T
R309	7030003560	S.RESISTOR ERJ3GEYJ 103 V (10 kΩ)	T
R310	7030003440	S.RESISTOR ERJ3GEYJ 102 V (1 kΩ)	T
R311	7030003440	S.RESISTOR ERJ3GEYJ 102 V (1 kΩ)	T
R312	7030003440	S.RESISTOR ERJ3GEYJ 102 V (1 kΩ)	T
R313	7030003440	S.RESISTOR ERJ3GEYJ 102 V (1 kΩ)	T
R314	7030003440	S.RESISTOR ERJ3GEYJ 102 V (1 kΩ)	T
R315	7030003440	S.RESISTOR ERJ3GEYJ 102 V (1 kΩ)	T
R316	7030003440	S.RESISTOR ERJ3GEYJ 102 V (1 kΩ)	T
R317	7030003440	S.RESISTOR ERJ3GEYJ 102 V (1 kΩ)	T
R318	7030003440	S.RESISTOR ERJ3GEYJ 102 V (1 kΩ)	T
R319	7030003440	S.RESISTOR ERJ3GEYJ 102 V (1 kΩ)	T
R320	7030003440	S.RESISTOR ERJ3GEYJ 102 V (1 kΩ)	T
R321	7030003440	S.RESISTOR ERJ3GEYJ 102 V (1 kΩ)	T
R322	7030003440	S.RESISTOR ERJ3GEYJ 102 V (1 kΩ)	T
R323	7030003560	S.RESISTOR ERJ3GEYJ 103 V (10 kΩ)	T
R325	7030003380	S.RESISTOR ERJ3GEYJ 331 V (330 Ω)	T
R326	7030003360	S.RESISTOR ERJ3GEYJ 221 V (220 Ω)	T
R327	7030003580	S.RESISTOR ERJ3GEYJ 153 V (15 kΩ)	T
R328	7030003660	S.RESISTOR ERJ3GEYJ 683 V (68 kΩ)	T
R329	7030003560	S.RESISTOR ERJ3GEYJ 103 V (10 kΩ)	T
R330	7030003480	S.RESISTOR ERJ3GEYJ 222 V (2.2 kΩ)	T
R331	7030003640	S.RESISTOR ERJ3GEYJ 473 V (47 kΩ)	T
R332	7030003640	S.RESISTOR ERJ3GEYJ 473 V (47 kΩ)	T
R333	7030003640	S.RESISTOR ERJ3GEYJ 473 V (47 kΩ)	T
R334	7030003640	S.RESISTOR ERJ3GEYJ 473 V (47 kΩ)	T
R335	7030003670	S.RESISTOR ERJ3GEYJ 823 V (82 kΩ)	T
R336	7030003670	S.RESISTOR ERJ3GEYJ 823 V (82 kΩ)	T
R337	7030003670	S.RESISTOR ERJ3GEYJ 823 V (82 kΩ)	T
R338	7030003670	S.RESISTOR ERJ3GEYJ 823 V (82 kΩ)	T
R339	7070000261	RESISTOR ERG2SJ 220 (22 Ω)	T
R340	7070000261	RESISTOR ERG2SJ 220 (22 Ω)	T
R342	7030003640	S.RESISTOR ERJ3GEYJ 473 V (47 kΩ)	T
R343	7030003640	S.RESISTOR ERJ3GEYJ 473 V (47 kΩ)	T
R351	7030003440	S.RESISTOR ERJ3GEYJ 102 V (1 kΩ)	T
R352	7030003440	S.RESISTOR ERJ3GEYJ 102 V (1 kΩ)	T
R353	7030003440	S.RESISTOR ERJ3GEYJ 102 V (1 kΩ)	T
R354	7030003440	S.RESISTOR ERJ3GEYJ 102 V (1 kΩ)	T
R355	7030003440	S.RESISTOR ERJ3GEYJ 102 V (1 kΩ)	T
R356	7030003440	S.RESISTOR ERJ3GEYJ 102 V (1 kΩ)	T
R357	7030003440	S.RESISTOR ERJ3GEYJ 102 V (1 kΩ)	T
R358	7030003440	S.RESISTOR ERJ3GEYJ 102 V (1 kΩ)	T
R359	7030003440	S.RESISTOR ERJ3GEYJ 102 V (1 kΩ)	T
R360	7030003440	S.RESISTOR ERJ3GEYJ 102 V (1 kΩ)	T
R361	7030003440	S.RESISTOR ERJ3GEYJ 102 V (1 kΩ)	T
R362	7030003440	S.RESISTOR ERJ3GEYJ 102 V (1 kΩ)	T
R363	7030003440	S.RESISTOR ERJ3GEYJ 102 V (1 kΩ)	T
R364	7030003640	S.RESISTOR ERJ3GEYJ 473 V (47 kΩ)	T
R365	7030004730	S.RESISTOR ERJ3GEYF 222 V (2.2 kΩ)	T
R366	7030003440	S.RESISTOR ERJ3GEYJ 102 V (1 kΩ)	T
R369	7030003860	S.RESISTOR ERJ3GE JPW V	T
R501	7030003640	S.RESISTOR ERJ3GEYJ 473 V (47 kΩ)	T
R502	7030003640	S.RESISTOR ERJ3GEYJ 473 V (47 kΩ)	T
R503	7030003640	S.RESISTOR ERJ3GEYJ 473 V (47 kΩ)	T
R504	7030003440	S.RESISTOR ERJ3GEYJ 102 V (1 kΩ)	T
R505	7030003360	S.RESISTOR ERJ3GEYJ 221 V (220 Ω)	T
R601	7030003860	S.RESISTOR ERJ3GE JPW V	T
R602	7030003520	S.RESISTOR ERJ3GEYJ 472 V (4.7 kΩ)	T
R603	7030003640	S.RESISTOR ERJ3GEYJ 473 V (47 kΩ)	T
R604	7030003560	S.RESISTOR ERJ3GEYJ 103 V (10 kΩ)	T
R651	7030003650	S.RESISTOR ERJ3GEYJ 563 V (56 kΩ)	T
R652	7030003620	S.RESISTOR ERJ3GEYJ 333 V (33 kΩ)	T
R653	7030003520	S.RESISTOR ERJ3GEYJ 472 V (4.7 kΩ)	T
C8	4030011600	S.CERAMIC C1608 JB 1E 104K-T	T
C201	4310001170	MYLAR ECQE1A 124JBB	T
C202	4030016880	S.CERAMIC C4520 CH 3F 150KT-A	T
C203	4030007020	S.CERAMIC C1608 CH 1H 120J-T	T
C204	4030007020	S.CERAMIC C1608 CH 1H 120J-T	T
C205	4030011600	S.CERAMIC C1608 JB 1E 104K-T	T
C206	4030011600	S.CERAMIC C1608 JB 1E 104K-T	T
C207	4030011600	S.CERAMIC C1608 JB 1E 104K-T	T
C208	4030011600	S.CERAMIC C1608 JB 1E 104K-T	T
C209	4030011600	S.CERAMIC C1608 JB 1E 104K-T	T
C210	4030011600	S.CERAMIC C1608 JB 1E 104K-T	T
C211	4030011600	S.CERAMIC C1608 JB 1E 104K-T	T
C212	4510006650	S.ELECTROLYTIC ECEV1EA100SR	T
C213	4510006230	S.ELECTROLYTIC ECEV1EA470UP	T
C214	4510006650	S.ELECTROLYTIC ECEV1EA100SR	T
C215	4030011600	S.CERAMIC C1608 JB 1E 104K-T	T
C216	4030011600	S.CERAMIC C1608 JB 1E 104K-T	T
C217	4030011600	S.CERAMIC C1608 JB 1E 104K-T	T

[DISPLAY BOARD]

REF NO.	ORDER NO.	DESCRIPTION	M.
C218	4510006230	S.ELECTROLYTIC ECEV1EA470UP	T
C219	4030006860	S.CERAMIC C1608 JB 1H 102K-T	T
C220	4030011600	S.CERAMIC C1608 JB 1E 104K-T	T
C221	4030008960	S.CERAMIC C2012 JB 1C 104K-T	T
C222	4030011600	S.CERAMIC C1608 JB 1E 104K-T	T
C223	4030011600	S.CERAMIC C1608 JB 1E 104K-T	T
C224	4030011600	S.CERAMIC C1608 JB 1E 104K-T	T
C225	4030011600	S.CERAMIC C1608 JB 1E 104K-T	T
C226	4030011600	S.CERAMIC C1608 JB 1E 104K-T	T
C227	4030011600	S.CERAMIC C1608 JB 1E 104K-T	T
C228	4510006650	S.ELECTROLYTIC ECEV1EA100SR	T
C229	4030011600	S.CERAMIC C1608 JB 1E 104K-T	T
C230	4030006880	S.CERAMIC C1608 JB 1H 472K-T	T
C231	4030011600	S.CERAMIC C1608 JB 1E 104K-T	T
C232	4030011600	S.CERAMIC C1608 JB 1E 104K-T	T
C241	4030011600	S.CERAMIC C1608 JB 1E 104K-T	T
C242	4030011600	S.CERAMIC C1608 JB 1E 104K-T	T
C243	4030011600	S.CERAMIC C1608 JB 1E 104K-T	T
C244	4030011600	S.CERAMIC C1608 JB 1E 104K-T	T
C245	4030011600	S.CERAMIC C1608 JB 1E 104K-T	T
C246	4030011600	S.CERAMIC C1608 JB 1E 104K-T	T
C247	4030011600	S.CERAMIC C1608 JB 1E 104K-T	T
C248	4030011600	S.CERAMIC C1608 JB 1E 104K-T	T
C249	4030011600	S.CERAMIC C1608 JB 1E 104K-T	T
C250	4030011600	S.CERAMIC C1608 JB 1E 104K-T	T
C251	4030011600	S.CERAMIC C1608 JB 1E 104K-T	T
C252	4030011600	S.CERAMIC C1608 JB 1E 104K-T	T
C253	4030011600	S.CERAMIC C1608 JB 1E 104K-T	T
C254	4030011600	S.CERAMIC C1608 JB 1E 104K-T	T
C255	4030011600	S.CERAMIC C1608 JB 1E 104K-T	T
C256	4030011600	S.CERAMIC C1608 JB 1E 104K-T	T
C257	4030011600	S.CERAMIC C1608 JB 1E 104K-T	T
C258	4030011600	S.CERAMIC C1608 JB 1E 104K-T	T
C259	4030011600	S.CERAMIC C1608 JB 1E 104K-T	T
C260	4030011600	S.CERAMIC C1608 JB 1E 104K-T	T
C261	4030011600	S.CERAMIC C1608 JB 1E 104K-T	T
C262	4030011600	S.CERAMIC C1608 JB 1E 104K-T	T
C263	4030011600	S.CERAMIC C1608 JB 1E 104K-T	T
C264	4030011600	S.CERAMIC C1608 JB 1E 104K-T	T
C265	4030011600	S.CERAMIC C1608 JB 1E 104K-T	T
C266	4030011600	S.CERAMIC C1608 JB 1E 104K-T	T
C267	4030011600	S.CERAMIC C1608 JB 1E 104K-T	T
C268	4030011600	S.CERAMIC C1608 JB 1E 104K-T	T
C601	4510006650	S.ELECTROLYTIC ECEV1EA100SR	T
C602	4030011600	S.CERAMIC C1608 JB 1E 104K-T	T
C651	4030008890	S.CERAMIC C1608 JB 1H 273K-T	T
C652	4030011600	S.CERAMIC C1608 JB 1E 104K-T	T
J1	6510021720	S.CONNECTOR 30FLT-SM1-TB	T
J2	6510021720	S.CONNECTOR 30FLT-SM1-TB	T
J3	6510022470	S.CONNECTOR 40FLT-SM1-TB	T
J4	6510020530	S.CONNECTOR 52808-1891	T
J5	6510019970	S.CONNECTOR 52808-1091	T
J6	6510021720	S.CONNECTOR 30FLT-SM1-TB	T
J7	6510019970	S.CONNECTOR 52808-1091	T
J201	6510022470	S.CONNECTOR 40FLT-SM1-TB	T
J202	6510022470	S.CONNECTOR 40FLT-SM1-TB	T
J203	6510020080	S.CONNECTOR 52808-2091	T
J205	6510003400	CONNECTOR B04B-EH-S	T
J301	6510021180	S.CONNECTOR SM02 (8.0) B-BHS-1-TB	T
J302	6510022190	S.CONNECTOR B3B-PH-SM3-TB	T
J601	6510021860	CONNECTOR BH-800.8 <LTC>	T
T201	5910000980	TRANSFORMER 3319-T088	T
BI 601	3020000110	LITHIUM CR2032	T
EP1	0910057592	PCB B 5966B	T

M.=Mounted side (T: Mounted on the Top side, B: Mounted on the Bottom side)

S.=Surface mount

[RXPLL-A UNIT]

REF NO.	ORDER NO.	DESCRIPTION	M.	
IC1	1130011530	S.IC	CD74HC4094M96	T
IC2	1130009690	S.IC	TC74HCT7007AF	T
IC51	1180001250	S.IC	TA7808F (TE16L)	T
IC61	1180000420	S.IC	TA78L05F (TE12R)	B
IC101	1140007880	S.IC	TC190G08AF-0046-Z/SC-1246A	T
IC102	1130003830	S.IC	TC7S04F (TE85R)	T
IC103	1130006440	S.IC	TC7S08F (TE85R)	B
IC104	1130003830	S.IC	TC7S04F (TE85R)	T
IC201	1130009230	S.IC	LMX2306TMX	T
IC501	1140007880	S.IC	TC190G08AF-0046-Z/SC-1246A	T
IC502	1130003830	S.IC	TC7S04F (TE85R)	T
IC503	1130003830	S.IC	TC7S04F (TE85R)	T
IC602	1130006440	S.IC	TC7S08F (TE85R)	B
IC651	1140004550	S.IC	M65343FP/SC1287	T
IC652	1130003830	S.IC	TC7S04F (TE85R)	T
IC1051	1190002010	S.IC	SD5400CY <IA>	T
IC1081	1110006180	S.IC	UPG2009TB-E3	B
IC1402	1110006180	S.IC	UPG2009TB-E3	T
IC1403	1110006180	S.IC	UPG2009TB-E3	T
IC1501	1110006120	S.IC	DBM9A41-TR	T
IC1502	1110006120	S.IC	DBM9A41-TR	T
IC1503	1110006100	S.IC	NJM5534MD-TE1	T
IC1504	1110006100	S.IC	NJM5534MD-TE1	T
IC1505	1110006190	S.IC	NJM074M-TE1	T
IC1506	1110006100	S.IC	NJM5534MD-TE1	T
IC1651	1130011920	S.IC	TC74LCX00F (EL)	T
IC1652	1110005420	S.IC	BA15532F-E2	T
IC1653	1110005100	S.IC	NJM072BM-TE2	B
IC1701	1130011530	S.IC	CD74HC4094M96	T
IC1702	1130011530	S.IC	CD74HC4094M96	T
IC1703	1160000130	S.IC	TD62783AF (S,EL)	T
IC1704	1180000790	S.IC	AN78L10M (E1)	B
Q1	1590001050	S.TRANSISTOR	DTC114TUA T106	B
Q30	1530002060	S.TRANSISTOR	2SC4081 T106 R	T
Q41	1590000680	S.TRANSISTOR	DTC114EUA T106	T
Q150	1560000330	S.FET	2SK210-GR (TE85R)	T
Q151	1530002280	S.TRANSISTOR	2SC4081 T106 S	T
Q152	1530002280	S.TRANSISTOR	2SC4081 T106 S	B
Q201	1590001330	S.TRANSISTOR	DTA114EUA T106	T
Q202	1560000530	S.FET	2SK880-GR (TE85R)	B
Q203	1530002490	S.TRANSISTOR	2SC3324-GR (TE85R)	T
Q204	1530002490	S.TRANSISTOR	2SC3324-GR (TE85R)	T
Q220	1560000330	S.FET	2SK210-GR (TE85R)	T
Q221	1530002060	S.TRANSISTOR	2SC4081 T106 R	T
Q230	1560000330	S.FET	2SK210-GR (TE85R)	T
Q240	1560000330	S.FET	2SK210-GR (TE85R)	T
Q250	1560000330	S.FET	2SK210-GR (TE85R)	T
Q260	1560000330	S.FET	2SK210-GR (TE85R)	T
Q270	1560000330	S.FET	2SK210-GR (TE85R)	T
Q280	1590000680	S.TRANSISTOR	DTC114EUA T106	T
Q281	1590000680	S.TRANSISTOR	DTC114EUA T106	T
Q282	1590000680	S.TRANSISTOR	DTC114EUA T106	T
Q283	1590000680	S.TRANSISTOR	DTC114EUA T106	T
Q284	1590000680	S.TRANSISTOR	DTC114EUA T106	T
Q285	1590000680	S.TRANSISTOR	DTC114EUA T106	T
Q301	1530003430	S.TRANSISTOR	2SC5226-4-TL	T
Q302	1530003430	S.TRANSISTOR	2SC5226-4-TL	B
Q341	1590000680	S.TRANSISTOR	DTC114EUA T106	T
Q351	1580000750	S.FET	3SK294 (TE85L)	T
Q352	1530003430	S.TRANSISTOR	2SC5226-4-TL	B
Q363	1590000680	S.TRANSISTOR	DTC114EUA T106	T
Q364	1590001330	S.TRANSISTOR	DTA114EUA T106	T
Q421	1590000680	S.TRANSISTOR	DTC114EUA T106	B
Q422	1590000680	S.TRANSISTOR	DTC114EUA T106	B
Q441	1590000680	S.TRANSISTOR	DTC114EUA T106	T
Q502	1590000680	S.TRANSISTOR	DTC114EUA T106	T
Q540	1530002060	S.TRANSISTOR	2SC4081 T106 H	B
Q541	1560000330	S.FET	2SK210-GR (TE85R)	T
Q561	1530003430	S.TRANSISTOR	2SC5226-4-TL	T
Q580	1530003430	S.TRANSISTOR	2SC5226-4-TL	T
Q591	1530003150	S.TRANSISTOR	2SC4673D-TD	T
Q592	1520000560	S.TRANSISTOR	2SB1123T-TD	B
Q593	1590000680	S.TRANSISTOR	DTC114EUA T106	B
Q680	1530002060	S.TRANSISTOR	2SC4081 T106 R	T
Q702	1530002600	S.TRANSISTOR	2SC4215-O (TE85R)	T
Q801	1560000560	S.FET	2SK882-GR (TE85L)	T
Q811	1560000560	S.FET	2SK882-GR (TE85L)	T
Q831	1560000560	S.FET	2SK882-GR (TE85L)	T
Q832	1520000560	S.TRANSISTOR	2SB1123T-TD	B
Q833	1590000680	S.TRANSISTOR	DTC114EUA T106	B
Q1001	1530003850	S.TRANSISTOR	2SC5551F-TD	B
Q1004	1590001960	S.TRANSISTOR	XP4311 (TX)	T
Q1005	1590001960	S.TRANSISTOR	XP4311 (TX)	T
Q1006	1530003850	S.TRANSISTOR	2SC5551F-TD	B
Q1007	1530003850	S.TRANSISTOR	2SC5551F-TD	B
Q1008	1530003850	S.TRANSISTOR	2SC5551F-TD	B

M.=Mounted side (T: Mounted on the Top side, B: Mounted on the Bottom side)

[RXPLL-A UNIT]

REF NO.	ORDER NO.	DESCRIPTION	M.	
Q1101	1530003860	TRANSISTOR	2SC3950D	T
Q1102	1590000680	S.TRANSISTOR	DTC114EUA T106	T
Q1103	1520000560	S.TRANSISTOR	2SB1123T-TD	B
Q1104	1530003860	TRANSISTOR	2SC3950D	T
Q1105	1530003840	S.TRANSISTOR	2SC5501-4-TR	T
Q1205	1590001960	S.TRANSISTOR	XP4311 (TX)	T
Q1209	1530003850	S.TRANSISTOR	2SC5551F-TD	B
Q1210	1530003850	S.TRANSISTOR	2SC5551F-TD	B
Q1211	1560001310	S.FET	MMBFU310LT1	T
Q1212	1560001310	S.FET	MMBFU310LT1	T
Q1213	1590000680	S.TRANSISTOR	DTC114EUA T106	B
Q1214	1520000560	S.TRANSISTOR	2SB1123T-TD	B
Q1301	1530003150	S.TRANSISTOR	2SC4402-3-TL	T
Q1352	1530003850	S.TRANSISTOR	2SC5551F-TD	B
Q1401	1530003840	S.TRANSISTOR	2SC5501-4-TR	T
Q1402	1530003020	S.TRANSISTOR	2SC4402-3-TL	T
Q1403	1530003020	S.TRANSISTOR	2SC4402-3-TL	T
Q1501	1530003450	S.TRANSISTOR	2SC4835-R (TX)	T
Q1502	1530003450	S.TRANSISTOR	2SC4835-R (TX)	T
Q1651	1530002600	S.TRANSISTOR	2SC4215-O (TE85R)	B
Q1701	1590001960	S.TRANSISTOR	XP4311 (TX)	T
Q1702	1590001960	S.TRANSISTOR	XP4311 (TX)	T
Q1703	1590001960	S.TRANSISTOR	XP4311 (TX)	T
D101	1750000520	S.DIODE	DAN222TL	T
D152	1720000590	S.VARICAP	MA357 (TX)	T
D153	1790000490	S.DIODE	HSM88AS-TR	T
D154	1790000490	S.DIODE	HSM88AS-TR	T
D201	1750000520	S.DIODE	DAN222TL	T
D220	1720000590	S.VARICAP	MA357 (TX)	T
D221	1720000590	S.VARICAP	MA357 (TX)	T
D222	1790000620	S.DIODE	MA77 (TX)	T
D230	1720000590	S.VARICAP	MA357 (TX)	T
D231	1720000590	S.VARICAP	MA357 (TX)	T
D232	1790000620	S.DIODE	MA77 (TX)	T
D240	1720000590	S.VARICAP	MA357 (TX)	T
D241	1720000590	S.VARICAP	MA357 (TX)	T
D242	1790000620	S.DIODE	MA77 (TX)	T
D250	1720000590	S.VARICAP	MA357 (TX)	T
D251	1720000590	S.VARICAP	MA357 (TX)	T
D252	1790000620	S.DIODE	MA77 (TX)	T
D261	1720000590	S.VARICAP	MA357 (TX)	T
D262	1790000620	S.DIODE	MA77 (TX)	T
D271	1720000590	S.VARICAP	MA357 (TX)	T
D272	1790000620	S.DIODE	MA77 (TX)	T
D341	1790000620	S.DIODE	MA77 (TX)	T
D342	1750000520	S.DIODE	DAN222TL	B
D362	1790000620	S.DIODE	MA77 (TX)	T
D363	1790000620	S.DIODE	MA77 (TX)	T
D421	1790000620	S.DIODE	MA77 (TX)	T
D422	1790000620	S.DIODE	MA77 (TX)	T
D423	1790000620	S.DIODE	MA77 (TX)	T
D424	1790000620	S.DIODE	MA77 (TX)	T
D441	1790000620	S.DIODE	MA77 (TX)	T
D501	1750000520	S.DIODE	DAN222TL	T
D541	1720000590	S.VARICAP	MA357 (TX)	T
D542	1720000590	S.VARICAP	MA357 (TX)	T
D821	1750000430	S.DIODE	HSB88WSTR	T
D1001	1750000580	S.DIODE	1SV307 (TPH3)	T
D1101	1790000620	S.DIODE	MA77 (TX)	T
D1102	1790000620	S.DIODE	MA77 (TX)	T
D1201	1750000580	S.DIODE	1SV307 (TPH3)	T
D1351	1750000580	S.DIODE	1SV307 (TPH3)	T
D1653	1750000550	S.DIODE	1SS355 TE-17	T
D1654	1750000550	S.DIODE	1SS355 TE-17	T
D1701	1790001670	S.DIODE	RB706F-40T106	T
FI101	2020001820	S.CERAMIC	SFECV10M5FA00-R0	T
FI831	2030000300	S.MONOLITH	FL-356 (64.491 MHz)	T
FI1401	2030000280	S.MONOLITH	FL-364 (64.455 MHz)	T
FI1402	2030000330	S.MONOLITH	FL-358 (64.455 MHz)	T
L1	6200003260	S.COIL	NL 322522T-101J	T
L2	6200003260	S.COIL	NL 322522T-101J	T
L10	6200003950	S.COIL	HF50ACC 322513-T	T
L11	6200003950	S.COIL	HF50ACC 322513-T	T
L12	6200003950	S.COIL	HF50ACC 322513-T	T
L13	6200003950	S.COIL	HF50ACC 322513-T	T
L20	6200003320	S.COIL	NL 322522T-3R3J-3	T
L30	6200005490	S.COIL	NL 322522T-331J	T
L101	6200001830	S.COIL	NL 322522T-100J	T
L151	6130002970	COIL	LB-343	T
L152	6200001830	S.COIL	NL 322522T-100J	T
L201	6200005010	S.COIL	NL 252018T-100J	T
L211	6200003660	S.COIL		B

S.=Surface mount

[RXPLL-A UNIT]

REF NO.	ORDER NO.	DESCRIPTION	M.
L220	6200010790	S.COIL C2520C-3R9G-A	T
L221	6190001420	COIL E526GN-110502	T
L222	6200010790	S.COIL C2520C-3R9G-A	T
L230	6200010830	S.COIL C2520C-3R3G-A	T
L231	6190001420	COIL E526GN-110502	T
L232	6200010830	S.COIL C2520C-3R3G-A	T
L240	6200010830	S.COIL C2520C-3R3G-A	T
L241	6190001420	COIL E526GN-110502	T
L242	6200010830	S.COIL C2520C-3R3G-A	T
L250	6200010820	S.COIL C2520C-2R7G-A	T
L251	6190001420	COIL E526GN-110502	T
L252	6200010820	S.COIL C2520C-2R7G-A	T
L260	6200010820	S.COIL C2520C-2R7G-A	T
L261	6190001410	COIL E526GN-110501	T
L262	6200010820	S.COIL C2520C-2R7G-A	T
L270	6200010810	S.COIL C2520C-2R2G-A	T
L271	6190001410	COIL E526GN-110501	T
L272	6200010810	S.COIL C2520C-2R2G-A	T
L280	6200005010	S.COIL NL 252018T-100J	T
L302	6200001830	S.COIL NL 322522T-100J	T
L331	6200002640	S.COIL NL 252018T-R15J	T
L332	6200002410	S.COIL NL 252018T-056J	B
L341	6200003260	S.COIL NL 322522T-101J	T
L351	6200001830	S.COIL NL 322522T-100J	T
L421	6200008640	S.COIL NL 322522T-391J	T
L441	6200002600	S.COIL NL 252018T-047J	T
L442	6200010730	S.COIL C2520C-68NG-A	T
L451	6200002640	S.COIL NL 252018T-R15J	T
L452	6200003260	S.COIL NL 322522T-101J	T
L501	6200001830	S.COIL NL 322522T-100J	T
L530	6200003170	S.COIL NL 322522T-330J	T
L531	6200003170	S.COIL NL 322522T-330J	T
L532	6200003170	S.COIL NL 322522T-330J	T
L541	6200010790	S.COIL C2520C-3R9G-A	T
L542	6190001420	COIL E526GN-110502	T
L543	6200010790	S.COIL C2520C-3R9G-A	T
L544	6200003260	S.COIL NL 322522T-101J	B
L545	6200003260	S.COIL NL 322522T-101J	T
L561	6200003260	S.COIL NL 322522T-101J	B
L562	6200001830	S.COIL NL 322522T-100J	B
L565	6150004250	COIL LS-471A (C-14922)	T
L566	6150004250	COIL LS-471A (C-14922)	T
L591	6200007790	S.COIL LQW2BHN15J01L (LQN21A R15J04)	T
L651	6200001830	S.COIL NL 322522T-100J	T
L681	6200005490	S.COIL NL 322522T-331J	T
L682	6200008640	S.COIL NL 322522T-391J	T
L683	6200008640	S.COIL NL 322522T-391J	T
L701	6200003260	S.COIL NL 322522T-101J	T
L702	6150004970	S.COIL LS-522	T
L703	6150004970	S.COIL LS-522	T
L801	6150004280	COIL LS-484B (C-14927)	T
L812	6200003230	S.COIL NL 322522T-181J	B
L821	6140003530	COIL LR-395	T
L822	6140003530	COIL LR-395	T
L831	6140003770	S.COIL LR-414 4KBL (STP-01435)	T
L834	6150004280	COIL LS-484B (C-14927)	T
L1001	6190001650	COIL ELC06D102E	T
L1002	6140004400	COIL LR-499	T
L1004	6140003890	COIL LR-488	T
L1005	6180001000	COIL LAL 04NA 102K	T
L1006	6140003900	COIL LR-489	T
L1007	6140003800	COIL LR-439	T
L1008	6190001650	COIL ELC06D102E	T
L1009	6190001650	COIL ELC06D102E	T
L1010	6140003880	S.COIL LR-486	T
L1011	6140003880	S.COIL LR-486	T
L1012	6140003800	COIL LR-439	T
L1013	6200010680	S.COIL C2520C-R22G (0.22U)	T
L1014	6200010680	S.COIL C2520C-R22G (0.22U)	T
L1015	6200007790	S.COIL LQW2BHN15J01L (LQN21A R15J04)	B
L1052	6200010740	S.COIL C2520C-R27G-A	T
L1053	6200010740	S.COIL C2520C-R27G-A	T
L1054	6200010740	S.COIL C2520C-R27G-A	T
L1055	6140003960	COIL LR-495	T
L1056	6200010730	S.COIL C2520C-68NG-A	T
L1058	6190001630	COIL E544EN-100021	T
L1059	6200010650	S.COIL C2520C-R12G (0.12U)	T
L1060	6200010870	S.COIL C2520C-R33G (0.33U)	T
L1062	6200010660	S.COIL C2520C-R15G (0.15U)	T
L1071	6200007780	S.COIL LQW2BHN12J01L (LQN21A R12J04)	B
L1072	6200007780	S.COIL LQW2BHN12J01L (LQN21A R12J04)	B
L1091	6200003950	S.COIL HF50ACC 322513-T	B
L1092	6200003950	S.COIL HF50ACC 322513-T	T
L1093	6200003950	S.COIL HF50ACC 322513-T	T
L1101	6140003920	COIL LR-491	T
L1102	6200010670	S.COIL C2520C-R18G (0.18U)	T
L1103	6180001250	COIL LAL 04NA 3R3K	T
L1104	6200010680	S.COIL C2520C-R22G (0.22U)	T

[RXPLL-A UNIT]

REF NO.	ORDER NO.	DESCRIPTION	M.
L1105	6140003910	COIL LR-490	T
L1208	6140003800	COIL LR-439	T
L1209	6200001830	S.COIL NL 322522T-100J	T
L1210	6140003870	COIL LR-487	T
L1211	6200009690	S.COIL LQH43CN101K01L (LQH 4C 101K04)	T
L1212	6200001830	S.COIL NL 322522T-100J	T
L1213	6140003870	COIL LR-487	T
L1214	6200009690	S.COIL LQH43CN101K01L (LQH 4C 101K04)	T
L1216	6140003800	COIL LR-439	T
L1217	6200007750	S.COIL LQW2BHN56NJ01L (LQN21A 56NJ04)	T
L1218	6200007770	S.COIL LQW2BHN10J01L (LQN21A R10J04)	T
L1219	6200007790	S.COIL LQW2BHN15J01L (LQN21A R15J04)	T
L1220	6140000930	COIL LR-116	T
L1221	6200003260	S.COIL NL 322522T-101J	B
L1222	6150001770	COIL LS-198	T
L1228	6200010870	S.COIL C2520C-R33G (0.33U)	T
L1229	6200003950	S.COIL HF50ACC 322513-T	B
L1301	6200008090	S.COIL LQW2BHN68NJ01L (LQN21A 68NJ04)	T
L1302	6200008090	S.COIL LQW2BHN68NJ01L (LQN21A 68NJ04)	T
L1303	6200008090	S.COIL LQW2BHN68NJ01L (LQN21A 68NJ04)	T
L1304	6200010870	S.COIL C2520C-R33G (0.33U)	T
L1305	6200003000	S.COIL NL 322522T-R22J-3	T
L1306	6200001830	S.COIL NL 322522T-100J	B
L1307	6200003000	S.COIL NL 322522T-R22J-3	T
L1351	6200001830	S.COIL NL 322522T-100J	T
L1353	6200010740	S.COIL C2520C-R27G-A	T
L1354	6200001830	S.COIL NL 322522T-100J	T
L1401	6150004280	COIL LS-484B (C-14927)	T
L1402	6150004280	COIL LS-484B (C-14927)	T
L1403	6150004280	COIL LS-484B (C-14927)	T
L1404	6150004280	COIL LS-484B (C-14927)	T
L1405	6200007770	S.COIL LQW2BHN10J01L (LQN21A R10J04)	B
L1406	6200007750	S.COIL LQW2BHN56NJ01L (LQN21A 56NJ04)	B
L1407	6140003930	COIL LR-492	T
L1408	6190001620	COIL E544EN-100028	T
L1409	6200003190	S.COIL NL 322522T-470J	B
L1501	6200003520	S.COIL ELJFB 102K-F	T
L1652	6200002520	S.COIL ELJNC R18K-F	T
L1653	6200001830	S.COIL NL 322522T-100J	B
L1654	6200001830	S.COIL NL 322522T-100J	B
L1655	6200001830	S.COIL NL 322522T-100J	B
L1701	6200001830	S.COIL NL 322522T-100J	T
L1702	6200003950	S.COIL HF50ACC 322513-T	T
L1703	6200003950	S.COIL HF50ACC 322513-T	T
L1704	6200003950	S.COIL HF50ACC 322513-T	T
L1705	6200003950	S.COIL HF50ACC 322513-T	T
L1803	6200003950	S.COIL HF50ACC 322513-T	B
L1804	6200003950	S.COIL HF50ACC 322513-T	B
L1805	6200003950	S.COIL HF50ACC 322513-T	B
L1807	6200003950	S.COIL HF50ACC 322513-T	B
L1808	6200003950	S.COIL HF50ACC 322513-T	B
L1809	6200003950	S.COIL HF50ACC 322513-T	B
R1	7030005871	S.RESISTOR ERA3YKD 104V (100 kΩ)	T
R2	7030005321	S.RESISTOR ERA3YED 103V	T
R3	7030003550	S.RESISTOR ERJ3GEYJ 822 V (8.2 kΩ)	T
R4	7030003550	S.RESISTOR ERJ3GEYJ 822 V (8.2 kΩ)	T
R5	7030003550	S.RESISTOR ERJ3GEYJ 822 V (8.2 kΩ)	T
R6	7030003550	S.RESISTOR ERJ3GEYJ 822 V (8.2 kΩ)	T
R10	7030003360	S.RESISTOR ERJ3GEYJ 221 V (220 Ω)	T
R11	7030003360	S.RESISTOR ERJ3GEYJ 221 V (220 Ω)	T
R12	7030003360	S.RESISTOR ERJ3GEYJ 221 V (220 Ω)	T
R13	7030003360	S.RESISTOR ERJ3GEYJ 221 V (220 Ω)	T
R14	7030003360	S.RESISTOR ERJ3GEYJ 221 V (220 Ω)	T
R15	7030003360	S.RESISTOR ERJ3GEYJ 221 V (220 Ω)	T
R16	7030003360	S.RESISTOR ERJ3GEYJ 221 V (220 Ω)	T
R17	7030003360	S.RESISTOR ERJ3GEYJ 221 V (220 Ω)	T
H30	7030003240	S.RESISTOR ERJ3GEYJ 220 V (22 Ω)	T
R31	7030003600	S.RESISTOR ERJ3GEYJ 223 V (22 kΩ)	T
R32	7030003320	S.RESISTOR ERJ3GEYJ 101 V (100 Ω)	T
R33	7030003340	S.RESISTOR ERJ3GEYJ 151 V (150 Ω)	T
R51	7030011030	S.RESISTOR ERJ1TYJ 270U (27 Ω)	T
R52	7030010550	S.RESISTOR ERJ1TYJ 820U (82 Ω)	B
R61	7030011030	S.RESISTOR ERJ1TYJ 270U (27 Ω)	T
R100	7030003860	S.RESISTOR ERJ3GE JPW V	T
R101	7030003800	S.RESISTOR ERJ3GEYJ 105 V (1 MΩ)	T
R103	7030007230	S.RESISTOR ERA3YED 102V	T
R104	7030007230	S.RESISTOR ERA3YED 102V	T
R105	7030007230	S.RESISTOR ERA3YED 102V	T
R106	7030003360	S.RESISTOR ERJ3GEYJ 221 V (220 Ω)	T
R107	7030003320	S.RESISTOR ERJ3GEYJ 101 V (100 Ω)	T
R108	7030007230	S.RESISTOR ERA3YED 102V	T
R109	7030007230	S.RESISTOR ERA3YED 102V	T
R110	7030007220	S.RESISTOR ERA3YED 202V	T
R111	7030007220	S.RESISTOR ERA3YED 202V	T
R112	7030007220	S.RESISTOR ERA3YED 202V	T
R113	7030007220	S.RESISTOR ERA3YED 202V	T

M.=Mounted side (T: Mounted on the Top side, B: Mounted on the Bottom side)

S.=Surface mount

[RXPLL-A UNIT]

REF NO.	ORDER NO.	DESCRIPTION	M.
R114	7030007220	S.RESISTOR ERA3YED 202V	T
R115	7030007220	S.RESISTOR ERA3YED 202V	T
R116	7030007220	S.RESISTOR ERA3YED 202V	T
R117	7030007220	S.RESISTOR ERA3YED 202V	T
R118	7030007200	S.RESISTOR ERA3YEB 202V	T
R119	7030007200	S.RESISTOR ERA3YEB 202V	T
R120	7030007200	S.RESISTOR ERA3YEB 202V	T
R121	7030007200	S.RESISTOR ERA3YEB 202V	T
R122	7030007200	S.RESISTOR ERA3YEB 202V	T
R123	7030007230	S.RESISTOR ERA3YED 102V	T
R124	7030007230	S.RESISTOR ERA3YED 102V	T
R125	7030007230	S.RESISTOR ERA3YED 102V	T
R126	7030007230	S.RESISTOR ERA3YED 102V	T
R127	7030007230	S.RESISTOR ERA3YED 102V	T
R128	7030007230	S.RESISTOR ERA3YED 102V	T
R129	7030007210	S.RESISTOR ERA3YEB 102V	T
R130	7030007210	S.RESISTOR ERA3YEB 102V	T
R131	7030007210	S.RESISTOR ERA3YEB 102V	T
R132	7030007210	S.RESISTOR ERA3YEB 102V	T
R133	7030007210	S.RESISTOR ERA3YEB 102V	T
R134	7030009861	S.RESISTOR ERA3YED 471V	T
R135	7030003860	S.RESISTOR ERJ3GE JPW V	T
R136	7030003800	S.RESISTOR ERJ3GEYJ 105 V (1 MΩ)	T
R137	7030003200	S.RESISTOR ERJ3GEYJ 100 V (10 Ω)	T
R138	7030003860	S.RESISTOR ERJ3GE JPW V	T
R139	7030003860	S.RESISTOR ERJ3GE JPW V	T
R140	7030007230	S.RESISTOR ERA3YED 102V	B
R141	7030003320	S.RESISTOR ERJ3GEYJ 101 V (100 Ω)	B
R150	7030003330	S.RESISTOR ERJ3GEYJ 121 V (120 Ω)	B
R151	7030003220	S.RESISTOR ERJ3GEYJ 150 V (15 Ω)	B
R152	7030005321	S.RESISTOR ERA3YED 103V	B
R153	7030005321	S.RESISTOR ERA3YED 103V	T
R154	7030003320	S.RESISTOR ERJ3GEYJ 101 V (100 Ω)	B
R155	7030003350	S.RESISTOR ERJ3GEYJ 181 V (180 Ω)	B
R156	7030005871	S.RESISTOR ERA3YKD 104V (100 kΩ)	T
R157	7030005871	S.RESISTOR ERA3YKD 104V (100 kΩ)	T
R158	7030003340	S.RESISTOR ERJ3GEYJ 151 V (150 Ω)	T
R159	7030003320	S.RESISTOR ERJ3GEYJ 101 V (100 Ω)	B
R160	7030003360	S.RESISTOR ERJ3GEYJ 221 V (220 Ω)	B
R161	7030003640	S.RESISTOR ERJ3GEYJ 473 V (47 kΩ)	B
R163	7030003220	S.RESISTOR ERJ3GEYJ 150 V (15 Ω)	B
R164	7030003310	S.RESISTOR ERJ3GEYJ 820 V (82 Ω)	B
R165	7030003320	S.RESISTOR ERJ3GEYJ 101 V (100 Ω)	B
R166	7030003320	S.RESISTOR ERJ3GEYJ 101 V (100 Ω)	B
R167	7030003240	S.RESISTOR ERJ3GEYJ 220 V (22 Ω)	B
R168	7030003360	S.RESISTOR ERJ3GEYJ 221 V (220 Ω)	B
R169	7030003640	S.RESISTOR ERJ3GEYJ 473 V (47 kΩ)	B
R202	7030007230	S.RESISTOR ERA3YED 102V	T
R203	7030007230	S.RESISTOR ERA3YED 102V	T
R204	7030003360	S.RESISTOR ERJ3GEYJ 221 V (220 Ω)	T
R205	7030005321	S.RESISTOR ERA3YED 103V	T
R206	7030003220	S.RESISTOR ERJ3GEYJ 150 V (15 Ω)	T
R210	7030007230	S.RESISTOR ERA3YED 102V	T
R211	7030009591	S.RESISTOR ERA3YED 472V	T
R212	7030007230	S.RESISTOR ERA3YED 102V	T
R213	7030007230	S.RESISTOR ERA3YED 102V	T
R214	7030007230	S.RESISTOR ERA3YED 102V	T
R215	7030009861	S.RESISTOR ERA3YED 471V	T
R216	7030009861	S.RESISTOR ERA3YED 471V	T
R220	7030005871	S.RESISTOR ERA3YKD 104V (100 kΩ)	T
R221	7030005871	S.RESISTOR ERA3YKD 104V (100 kΩ)	T
R222	7030003360	S.RESISTOR ERJ3GEYJ 221 V (220 Ω)	T
R223	7030007230	S.RESISTOR ERA3YED 102V	T
R224	7030003320	S.RESISTOR ERJ3GEYJ 101 V (100 Ω)	T
R230	7030005871	S.RESISTOR ERA3YKD 104V (100 kΩ)	T
R231	7030005871	S.RESISTOR ERA3YKD 104V (100 kΩ)	T
R232	7030003360	S.RESISTOR ERJ3GEYJ 221 V (220 Ω)	T
R233	7030007230	S.RESISTOR ERA3YED 102V	T
R234	7030003320	S.RESISTOR ERJ3GEYJ 101 V (100 Ω)	T
R240	7030005871	S.RESISTOR ERA3YKD 104V (100 kΩ)	T
R241	7030005871	S.RESISTOR ERA3YKD 104V (100 kΩ)	T
R242	7030003360	S.RESISTOR ERJ3GEYJ 221 V (220 Ω)	T
R243	7030007230	S.RESISTOR ERA3YED 102V	T
R244	7030003320	S.RESISTOR ERJ3GEYJ 101 V (100 Ω)	T
R250	7030005871	S.RESISTOR ERA3YKD 104V (100 kΩ)	T
R251	7030005871	S.RESISTOR ERA3YKD 104V (100 kΩ)	T
R252	7030003360	S.RESISTOR ERJ3GEYJ 221 V (220 Ω)	T
R253	7030007230	S.RESISTOR ERA3YED 102V	T
R254	7030003320	S.RESISTOR ERJ3GEYJ 101 V (100 Ω)	T
R260	7030005871	S.RESISTOR ERA3YKD 104V (100 kΩ)	T
R261	7030005871	S.RESISTOR ERA3YKD 104V (100 kΩ)	T
R262	7030003360	S.RESISTOR ERJ3GEYJ 221 V (220 Ω)	T
R263	7030007230	S.RESISTOR ERA3YED 102V	T
R264	7030003320	S.RESISTOR ERJ3GEYJ 101 V (100 Ω)	T
R270	7030005871	S.RESISTOR ERA3YKD 104V (100 kΩ)	T
R271	7030005871	S.RESISTOR ERA3YKD 104V (100 kΩ)	T
R272	7030003360	S.RESISTOR ERJ3GEYJ 221 V (220 Ω)	T
R273	7030007230	S.RESISTOR ERA3YED 102V	T

M.—Mounted side (T: Mounted on the Top side, B: Mounted on the Bottom side)

[RXPLL-A UNIT]

REF NO.	ORDER NO.	DESCRIPTION	M.
R274	7030003320	S.RESISTOR ERJ3GEYJ 101 V (100 Ω)	T
R301	7030003200	S.RESISTOR ERJ3GEYJ 100 V (10 Ω)	T
R302	7030007230	S.RESISTOR ERA3YED 102V	T
R303	7030003360	S.RESISTOR ERJ3GEYJ 221 V (220 Ω)	T
R304	7030003490	S.RESISTOR ERJ3GEYJ 272 V (2.7 kΩ)	T
R305	7030003510	S.RESISTOR ERJ3GEYJ 392 V (3.9 kΩ)	T
R306	7030003360	S.RESISTOR ERJ3GEYJ 221 V (220 Ω)	T
R307	7030009841	S.RESISTOR ERA3YHD 330V	T
R308	7030009851	S.RESISTOR ERA3YED 271V	B
R309	7030003540	S.RESISTOR ERJ3GEYJ 682 V (6.8 kΩ)	B
R310	7030003500	S.RESISTOR ERJ3GEYJ 332 V (3.3 kΩ)	B
R311	7030003350	S.RESISTOR ERJ3GEYJ 181 V (180 Ω)	B
R317	7030006270	S.RESISTOR ERJ12YJ221U (220 Ω)	T
R318	7030009841	S.RESISTOR ERA3YHD 330V	B
R341	7030007230	S.RESISTOR ERA3YED 102V	T
R342	7030005321	S.RESISTOR ERA3YED 103V	T
R343	7030007230	S.RESISTOR ERA3YED 102V	T
R351	7030003200	S.RESISTOR ERJ3GEYJ 100 V (10 Ω)	B
R352	7030010980	S.RESISTOR ERA3YHD 470V	T
R353	7030009591	S.RESISTOR ERA3YED 472V	T
R354	7030009591	S.RESISTOR ERA3YED 472V	T
R355	7030009591	S.RESISTOR ERA3YED 472V	T
R356	7030003320	S.RESISTOR ERJ3GEYJ 101 V (100 Ω)	T
R357	7310002720	S.TRIMMER RV-148 (RH03A3AS3X0DA) 472	T
R358	7030010980	S.RESISTOR ERA3YHD 470V	T
R359	7030003320	S.RESISTOR ERJ3GEYJ 101 V (100 Ω)	T
R360	7030003320	S.RESISTOR ERJ3GEYJ 101 V (100 Ω)	B
R361	7030003490	S.RESISTOR ERJ3GEYJ 272 V (2.7 kΩ)	B
R362	7030003510	S.RESISTOR ERJ3GEYJ 392 V (3.9 kΩ)	B
R363	7030003320	S.RESISTOR ERJ3GEYJ 101 V (100 Ω)	B
R364	7030003410	S.RESISTOR ERJ3GEYJ 561 V (560 Ω)	T
R365	7030007860	S.RESISTOR ERJ3GEYJ 8R2V (8.2 Ω)	T
R366	7030003410	S.RESISTOR ERJ3GEYJ 561 V (560 Ω)	T
R368	7030005321	S.RESISTOR ERA3YED 103V	T
R369	7030008240	S.RESISTOR ERJ12YJ0R00U	B
R421	7030007230	S.RESISTOR ERA3YED 102V	T
R422	7030007230	S.RESISTOR ERA3YED 102V	T
R423	7030007230	S.RESISTOR ERA3YED 102V	T
R424	7030007230	S.RESISTOR ERA3YED 102V	T
R425	7030003410	S.RESISTOR ERJ3GEYJ 561 V (560 Ω)	T
R426	7030003410	S.RESISTOR ERJ3GEYJ 561 V (560 Ω)	T
R427	7030003320	S.RESISTOR ERJ3GEYJ 101 V (100 Ω)	B
R428	7030009861	S.RESISTOR ERA3YED 471V	B
R429	7030009861	S.RESISTOR ERA3YED 471V	B
R441	7030007230	S.RESISTOR ERA3YED 102V	T
R442	7030005321	S.RESISTOR ERA3YED 103V	T
R443	7030007230	S.RESISTOR ERA3YED 102V	T
R501	7030003360	S.RESISTOR ERJ3GEYJ 221 V (220 Ω)	T
R502	7030007230	S.RESISTOR ERA3YED 102V	T
R503	7030007230	S.RESISTOR ERA3YED 102V	T
R504	7030007230	S.RESISTOR ERA3YED 102V	T
R506	7030003800	S.RESISTOR ERJ3GEYJ 105 V (1 MΩ)	T
R507	7030003860	S.RESISTOR ERJ3GE JPW V	B
R509	7030007230	S.RESISTOR ERA3YED 102V	T
R510	7030007220	S.RESISTOR ERA3YED 202V	T
R511	7030007220	S.RESISTOR ERA3YED 202V	T
R512	7030007220	S.RESISTOR ERA3YED 202V	T
R513	7030007220	S.RESISTOR ERA3YED 202V	T
R514	7030007220	S.RESISTOR ERA3YED 202V	T
R515	7030007220	S.RESISTOR ERA3YED 202V	T
R516	7030007220	S.RESISTOR ERA3YED 202V	T
R517	7030007220	S.RESISTOR ERA3YED 202V	T
R518	7030007200	S.RESISTOR ERA3YEB 202V	T
R519	7030007200	S.RESISTOR ERA3YEB 202V	T
R520	7030007200	S.RESISTOR ERA3YEB 202V	T
R521	7030007200	S.RESISTOR ERA3YEB 202V	T
R522	7030007200	S.RESISTOR ERA3YEB 202V	T
R523	7030007230	S.RESISTOR ERA3YED 102V	T
H524	7030007230	S.RESISTOR ERA3YED 102V	T
R525	7030007230	S.RESISTOR ERA3YED 102V	T
R526	7030007230	S.RESISTOR ERA3YED 102V	T
R527	7030007230	S.RESISTOR ERA3YED 102V	T
R528	7030007230	S.RESISTOR ERA3YED 102V	T
R529	7030007210	S.RESISTOR ERA3YEB 102V	T
R530	7030007210	S.RESISTOR ERA3YEB 102V	T
R531	7030007210	S.RESISTOR ERA3YEB 102V	T
R532	7030007210	S.RESISTOR ERA3YEB 102V	T
R533	7030007210	S.RESISTOR ERA3YEB 102V	T
R534	7030003860	S.RESISTOR ERJ3GE JPW V	T
R535	7030003800	S.RESISTOR ERJ3GEYJ 105 V (1 MΩ)	T
R536	7030003200	S.RESISTOR ERJ3GEYJ 100 V (10 Ω)	T
R537	7030007230	S.RESISTOR ERA3YED 102V	T
R538	7030003360	S.RESISTOR ERJ3GEYJ 221 V (220 Ω)	B
R540	7030007230	S.RESISTOR ERA3YED 102V	B
R544	7030005871	S.RESISTOR ERA3YKD 104V (100 kΩ)	T
R545	7030005871	S.RESISTOR ERA3YKD 104V (100 kΩ)	T
R546	7030009861	S.RESISTOR ERA3YED 471V	T
R548	7030009591	S.RESISTOR ERA3YED 472V	B

S.—Surface mount

[RXPLL-A UNIT]

REF NO.	ORDER NO.	DESCRIPTION	M.
R550	7030009691	S.RESISTOR ERA3YED 101V (100 Ω)	B
R554	7030009691	S.RESISTOR ERA3YED 101V (100 Ω)	B
R555	7030003380	S.RESISTOR ERJ3GEYJ 331 V (330 Ω)	B
R556	7030003800	S.RESISTOR ERJ3GEYJ 105 V (1 MΩ)	B
R561	7030003200	S.RESISTOR ERJ3GEYJ 100 V (10 Ω)	T
R562	7030003360	S.RESISTOR ERJ3GEYJ 221 V (220 Ω)	T
R563	7030003490	S.RESISTOR ERJ3GEYJ 272 V (2.7 kΩ)	T
R564	7030003510	S.RESISTOR ERJ3GEYJ 392 V (3.9 kΩ)	T
R565	7030003360	S.RESISTOR ERJ3GEYJ 221 V (220 Ω)	T
R570	7030003230	S.RESISTOR ERJ3GEYJ 180 V (18 Ω)	T
R571	7030003230	S.RESISTOR ERJ3GEYJ 180 V (18 Ω)	T
R572	7030003290	S.RESISTOR ERJ3GEYJ 560 V (56 Ω)	B
R573	7030009841	S.RESISTOR ERA3YHD 330V	T
R574	7030003300	S.RESISTOR ERJ3GEYJ 680 V (68 Ω)	T
R575	7030003220	S.RESISTOR ERJ3GEYJ 150 V (15 Ω)	T
R580	7030009861	S.RESISTOR ERA3YED 471V	T
R581	7030003360	S.RESISTOR ERJ3GEYJ 221 V (220 Ω)	T
R582	7030003600	S.RESISTOR ERJ3GEYJ 223 V (22 kΩ)	T
R587	7030009851	S.RESISTOR ERA3YED 271V	T
R588	7030003230	S.RESISTOR ERJ3GEYJ 180 V (18 Ω)	T
R589	7030009851	S.RESISTOR ERA3YED 271V	T
R591	7030003320	S.RESISTOR ERJ3GEYJ 101 V (100 Ω)	T
R592	7030005321	S.RESISTOR ERA3YED 103V	T
R593	7030003480	S.RESISTOR ERJ3GEYJ 222 V (2.2 kΩ)	T
R594	7030003320	S.RESISTOR ERJ3GEYJ 101 V (100 Ω)	B
R595	7030003640	S.RESISTOR ERJ3GEYJ 473 V (47 kΩ)	B
R596	7030003540	S.RESISTOR ERJ3GEYJ 682 V (6.8 kΩ)	B
R603	7030003480	S.RESISTOR ERJ3GEYJ 222 V (2.2 kΩ)	T
R604	7030007230	S.RESISTOR ERA3YED 102V	B
R605	7030003320	S.RESISTOR ERJ3GEYJ 101 V (100 Ω)	T
R651	7030007230	S.RESISTOR ERA3YED 102V	B
R652	7030003360	S.RESISTOR ERJ3GEYJ 221 V (220 Ω)	T
R653	7030007230	S.RESISTOR ERA3YED 102V	T
R654	7030007230	S.RESISTOR ERA3YED 102V	T
R656	7030003800	S.RESISTOR ERJ3GEYJ 105 V (1 MΩ)	T
R657	7030003320	S.RESISTOR ERJ3GEYJ 101 V (100 Ω)	T
R661	7030007220	S.RESISTOR ERA3YED 202V	T
R662	7030007220	S.RESISTOR ERA3YED 202V	T
R663	7030007220	S.RESISTOR ERA3YED 202V	T
R664	7030007220	S.RESISTOR ERA3YED 202V	T
R665	7030007220	S.RESISTOR ERA3YED 202V	T
R666	7030007220	S.RESISTOR ERA3YED 202V	T
R667	7030007220	S.RESISTOR ERA3YED 202V	T
R668	7030007220	S.RESISTOR ERA3YED 202V	T
R669	7030007200	S.RESISTOR ERA3YED 202V	T
R670	7030007200	S.RESISTOR ERA3YED 202V	T
R671	7030007200	S.RESISTOR ERA3YED 202V	T
R673	7030007230	S.RESISTOR ERA3YED 102V	T
R674	7030007230	S.RESISTOR ERA3YED 102V	T
R675	7030007230	S.RESISTOR ERA3YED 102V	T
R676	7030007230	S.RESISTOR ERA3YED 102V	T
R677	7030007230	S.RESISTOR ERA3YED 102V	T
R678	7030007230	S.RESISTOR ERA3YED 102V	T
R679	7030007210	S.RESISTOR ERA3YED 102V	T
R680	7030007210	S.RESISTOR ERA3YED 102V	T
R681	7030007210	S.RESISTOR ERA3YED 102V	T
R682	7030003860	S.RESISTOR ERJ3GE JPW V	B
R685	7030003460	S.RESISTOR ERJ3GEYJ 152 V (1.5 kΩ)	T
R686	7030003320	S.RESISTOR ERJ3GEYJ 101 V (100 Ω)	T
R687	7030003470	S.RESISTOR ERJ3GEYJ 182 V (1.8 kΩ)	T
R688	7030003480	S.RESISTOR ERJ3GEYJ 222 V (2.2 kΩ)	T
R689	7030003360	S.RESISTOR ERJ3GEYJ 221 V (220 Ω)	T
R690	7030009851	S.RESISTOR ERA3YED 271V	T
R691	7030003230	S.RESISTOR ERJ3GEYJ 180 V (18 Ω)	T
R692	7030009851	S.RESISTOR ERA3YED 271V	T
R693	7030003500	S.RESISTOR ERJ3GEYJ 332 V (3.3 kΩ)	T
R704	7030009841	S.RESISTOR ERA3YHD 330V	T
R705	7030003600	S.RESISTOR ERJ3GEYJ 223 V (22 kΩ)	T
R706	7030005321	S.RESISTOR ERA3YED 103V	T
R707	7030009861	S.RESISTOR ERA3YED 471V	T
R708	7030003410	S.RESISTOR ERJ3GEYJ 561 V (560 Ω)	T
R709	7030007860	S.RESISTOR ERJ3GEYJ 8R2V (8.2 Ω)	T
R710	7030003410	S.RESISTOR ERJ3GEYJ 561 V (560 Ω)	T
R711	7030003320	S.RESISTOR ERJ3GEYJ 101 V (100 Ω)	T
R802	7030009861	S.RESISTOR ERA3YED 471V	T
R803	7030005321	S.RESISTOR ERA3YED 103V	T
R804	7030003320	S.RESISTOR ERJ3GEYJ 101 V (100 Ω)	T
R805	7030009851	S.RESISTOR ERA3YED 271V	T
R806	7030003230	S.RESISTOR ERJ3GEYJ 180 V (18 Ω)	T
R807	7030009851	S.RESISTOR ERA3YED 271V	T
R812	7030007230	S.RESISTOR ERA3YED 102V	T
R814	7030005321	S.RESISTOR ERA3YED 103V	T
R815	7030003320	S.RESISTOR ERJ3GEYJ 101 V (100 Ω)	T
R831	7030003320	S.RESISTOR ERJ3GEYJ 101 V (100 Ω)	B
R832	7030003300	S.RESISTOR ERJ3GEYJ 680 V (68 Ω)	B
R833	7030003320	S.RESISTOR ERJ3GEYJ 101 V (100 Ω)	B
R834	7030003380	S.RESISTOR ERJ3GEYJ 331 V (330 Ω)	T
R835	7030003320	S.RESISTOR ERJ3GEYJ 101 V (100 Ω)	T

[RXPLL-A UNIT]

REF NO.	ORDER NO.	DESCRIPTION	M.
R836	7030003380	S.RESISTOR ERJ3GEYJ 331 V (330 Ω)	T
R837	7030003220	S.RESISTOR ERJ3GEYJ 150 V (15 Ω)	T
R838	7030003380	S.RESISTOR ERJ3GEYJ 331 V (330 Ω)	T
R839	7030005321	S.RESISTOR ERA3YED 103V	B
R840	7030003540	S.RESISTOR ERJ3GEYJ 682 V (6.8 kΩ)	T
R1000	7030003320	S.RESISTOR ERJ3GEYJ 101 V (100 Ω)	B
R1001	7030003640	S.RESISTOR ERJ3GEYJ 473 V (47 kΩ)	T
R1002	7030003480	S.RESISTOR ERJ3GEYJ 222 V (2.2 kΩ)	T
R1003	7030010980	S.RESISTOR ERA3YHD 470V	T
R1004	7030007230	S.RESISTOR ERA3YED 102V	B
R1005	7030003550	S.RESISTOR ERJ3GEYJ 822 V (8.2 kΩ)	T
R1006	7030007230	S.RESISTOR ERA3YED 102V	T
R1007	7030004030	S.RESISTOR ERJ3GEYJ 5F6 V (5.6 Ω)	B
R1008	7030003240	S.RESISTOR ERJ3GEYJ 220 V (22 Ω)	T
R1009	7030010980	S.RESISTOR ERA3YHD 470V	T
R1010	7030010980	S.RESISTOR ERA3YHD 470V	T
R1011	7030003320	S.RESISTOR ERJ3GEYJ 101 V (100 Ω)	B
R1012	7030003320	S.RESISTOR ERJ3GEYJ 101 V (100 Ω)	B
R1013	7030007230	S.RESISTOR ERA3YED 102V	B
R1014	7030007230	S.RESISTOR ERA3YED 102V	B
R1015	7030003530	S.RESISTOR ERJ3GEYJ 562 V (5.6 kΩ)	B
R1016	7030003530	S.RESISTOR ERJ3GEYJ 562 V (5.6 kΩ)	B
R1017	7030003530	S.RESISTOR ERJ3GEYJ 562 V (5.6 kΩ)	B
R1018	7030003650	S.RESISTOR ERJ3GEYJ 563 V (56 kΩ)	B
R1019	7030005321	S.RESISTOR ERA3YED 103V	B
R1020	7030003390	S.RESISTOR ERJ3GEYJ 391 V (390 Ω)	T
R1021	7030003220	S.RESISTOR ERJ3GEYJ 150 V (15 Ω)	T
R1022	7030003390	S.RESISTOR ERJ3GEYJ 391 V (390 Ω)	T
R1023	7030010980	S.RESISTOR ERA3YHD 470V	B
R1024	7030003200	S.RESISTOR ERJ3GEYJ 100 V (10 Ω)	B
R1025	7030003300	S.RESISTOR ERJ3GEYJ 680 V (68 Ω)	T
R1026	7030003480	S.RESISTOR ERJ3GEYJ 222 V (2.2 kΩ)	B
R1051	7030003800	S.RESISTOR ERJ3GEYJ 105 V (1 MΩ)	T
R1054	7030010980	S.RESISTOR ERA3YHD 470V	T
R1055	7030000010	S.RESISTOR MCR10EZJH JPW (000)	T
R1056	7030000010	S.RESISTOR MCR10EZJH JPW (000)	T
R1071	7030010980	S.RESISTOR ERA3YHD 470V	B
R1101	7310004860	S.TRIMMER EVM-3YSX50 B53 (502)	T
R1102	7030005871	S.RESISTOR ERA3YKD 104V (100 kΩ)	B
R1103	7030007680	S.RESISTOR ERJ8ENF 47R0V (47 Ω)	T
R1104	7030007680	S.RESISTOR ERJ8ENF 47R0V (47 Ω)	T
R1105	7030003500	S.RESISTOR ERJ3GEYJ 332 V (3.3 kΩ)	T
R1106	7030009620	S.RESISTOR ERJ12YJ120U (12 Ω)	B
R1107	7030010980	S.RESISTOR ERA3YHD 470V	T
R1109	7030007180	S.RESISTOR ERJ12YJ150U (15 Ω)	B
R1110	7030003480	S.RESISTOR ERJ3GEYJ 222 V (2.2 kΩ)	B
R1111	7030003480	S.RESISTOR ERJ3GEYJ 222 V (2.2 kΩ)	T
R1113	7030003480	S.RESISTOR ERJ3GEYJ 222 V (2.2 kΩ)	T
R1114	7030004040	S.RESISTOR ERJ3GEYJ 4R7 V (4.7 Ω)	T
R1115	7030006240	S.RESISTOR ERJ12YJ181U (180 Ω)	B
R1116	7030007230	S.RESISTOR ERA3YED 102V	T
R1117	7030004040	S.RESISTOR ERJ3GEYJ 4R7 V (4.7 Ω)	T
R1118	7030003480	S.RESISTOR ERJ3GEYJ 222 V (2.2 kΩ)	T
R1119	7030003470	S.RESISTOR ERJ3GEYJ 182 V (1.8 kΩ)	T
R1120	7030006070	S.RESISTOR ERJ12YJ101U (100 Ω)	B
R1121	7030003240	S.RESISTOR ERJ3GEYJ 220 V (22 Ω)	T
R1122	7030010980	S.RESISTOR ERA3YHD 470V	T
R1123	7030003480	S.RESISTOR ERJ3GEYJ 222 V (2.2 kΩ)	T
R1124	7030003460	S.RESISTOR ERJ3GEYJ 152 V (1.5 kΩ)	T
R1125	7030003420	S.RESISTOR ERJ3GEYJ 681 V (680 Ω)	B
R1126	7030003200	S.RESISTOR ERJ3GEYJ 100 V (10 Ω)	T
R1127	7030010980	S.RESISTOR ERA3YHD 470V	T
R1128	7030003470	S.RESISTOR ERJ3GEYJ 182 V (1.8 kΩ)	T
R1129	7030003470	S.RESISTOR ERJ3GEYJ 182 V (1.8 kΩ)	T
R1130	7030003480	S.RESISTOR ERJ3GEYJ 222 V (2.2 kΩ)	T
R1131	7030003640	S.RESISTOR ERJ3GEYJ 473 V (47 kΩ)	B
R1132	7310004860	S.TRIMMER EVM-3YSX50 B53 (502)	T
R1133	7030003500	S.RESISTOR ERJ3GEYJ 332 V (3.3 kΩ)	T
R1134	7030003640	S.RESISTOR ERJ3GEYJ 473 V (47 kΩ)	T
R1135	7030005871	S.RESISTOR ERA3YKD 104V (100 kΩ)	T
R1203	7030000010	S.RESISTOR MCR10EZJH JPW (000)	T
R1208	7030003480	S.RESISTOR ERJ3GEYJ 222 V (2.2 kΩ)	T
R1209	7030005321	S.RESISTOR ERA3YED 103V	T
R1210	7030003650	S.RESISTOR ERJ3GEYJ 563 V (56 kΩ)	B
R1211	7030003860	S.RESISTOR ERJ3GE JPW V	T
R1212	7030003860	S.RESISTOR ERJ3GE JPW V	T
R1220	7030010980	S.RESISTOR ERA3YHD 470V	T
R1221	7030007230	S.RESISTOR ERA3YED 102V	T
R1222	7030003530	S.RESISTOR ERJ3GEYJ 562 V (5.6 kΩ)	T
R1223	7030010980	S.RESISTOR ERA3YHD 470V	T
R1224	7030007230	S.RESISTOR ERA3YED 102V	T
R1225	7030003530	S.RESISTOR ERJ3GEYJ 562 V (5.6 kΩ)	T
R1226	7030003410	S.RESISTOR ERJ3GEYJ 561 V (560 Ω)	T
R1227	7030003410	S.RESISTOR ERJ3GEYJ 561 V (560 Ω)	T
R1228	7310004860	S.TRIMMER EVM-3YSX50 B53 (502)	T
R1229	7030003480	S.RESISTOR ERJ3GEYJ 222 V (2.2 kΩ)	B
R1230	7030003480	S.RESISTOR ERJ3GEYJ 222 V (2.2 kΩ)	B
R1231	7030003480	S.RESISTOR ERJ3GEYJ 222 V (2.2 kΩ)	B

M.—Mounted side (T: Mounted on the Top side, B: Mounted on the Bottom side)

S.—Surface mount

[RXPLL-A UNIT]

REF NO.	ORDER NO.	DESCRIPTION	M.
R1232	7030003600	S.RESISTOR ERJ3GGEYJ 223 V (22 kΩ)	T
R1233	7030010980	S.RESISTOR ERA3YHD 470V	B
R1301	7030010980	S.RESISTOR ERA3YHD 470V	B
R1302	7030003360	S.RESISTOR ERJ3GGE JPW V	T
R1304	7030003620	S.RESISTOR ERJ3GGEYJ 333 V (33 kΩ)	T
R1306	7030006230	S.RESISTOR ERJ12YJ151U (150 Ω)	B
R1307	7030003300	S.RESISTOR ERJ3GGEYJ 680 V (68 Ω)	T
R1357	7030007230	S.RESISTOR ERA3YED 102V	B
R1358	7030003530	S.RESISTOR ERJ3GGEYJ 562 V (5.6 kΩ)	B
R1359	7030010980	S.RESISTOR ERA3YHD 470V	T
R1360	7030007230	S.RESISTOR ERA3YED 102V	B
R1361	7030003380	S.RESISTOR ERJ3GGEYJ 331 V (330 Ω)	T
R1362	7030005871	S.RESISTOR ERA3YKD 104V (100 kΩ)	B
R1401	7030003200	S.RESISTOR ERJ3GGEYJ 100 V (10 Ω)	T
R1402	7030003300	S.RESISTOR ERJ3GGEYJ 680 V (68 Ω)	T
R1403	7030007230	S.RESISTOR ERA3YED 102V	T
R1404	7030009861	S.RESISTOR ERA3YED 471V	T
R1405	7030003340	S.RESISTOR ERJ3GGEYJ 151 V (150 Ω)	T
R1406	7030009591	S.RESISTOR ERA3YED 472V	T
R1407	7030003550	S.RESISTOR ERJ3GGEYJ 822 V (8.2 kΩ)	T
R1408	7030003200	S.RESISTOR ERJ3GGEYJ 100 V (10 Ω)	T
R1409	7030009591	S.RESISTOR ERA3YED 472V	T
R1410	7030006091	S.RESISTOR ERA3YED 822V	B
R1411	7030005871	S.RESISTOR ERA3YKD 104V (100 kΩ)	T
R1412	7030003200	S.RESISTOR ERJ3GGEYJ 100 V (10 Ω)	T
R1413	7030003200	S.RESISTOR ERJ3GGEYJ 100 V (10 Ω)	T
R1414	7030005871	S.RESISTOR ERA3YKD 104V (100 kΩ)	B
R1415	7030010980	S.RESISTOR ERA3YHD 470V	T
R1416	7030003320	S.RESISTOR ERJ3GGEYJ 101 V (100 Ω)	B
R1417	7030000010	S.RESISTOR MCR10EZJH JPW (000)	B
R1418	7030000010	S.RESISTOR MCR10EZJH JPW (000)	B
R1419	7030003860	S.RESISTOR ERJ3GGE JPW V	B
R1501	7030010980	S.RESISTOR ERA3YHD 470V	T
R1502	7030009841	S.RESISTOR ERA3YHD 330V	T
R1503	7030009851	S.RESISTOR ERA3YED 271V	T
R1504	7030011050	S.RESISTOR ERA3YHD 100V	T
R1505	7030006091	S.RESISTOR ERA3YED 822V	B
R1506	7030007230	S.RESISTOR ERA3YED 102V	T
R1507	7030007230	S.RESISTOR ERA3YED 102V	T
R1508	7030007230	S.RESISTOR ERA3YED 102V	T
R1509	7030007230	S.RESISTOR ERA3YED 102V	T
R1510	7030005321	S.RESISTOR ERA3YED 103V	T
R1511	7030009861	S.RESISTOR ERA3YED 471V	T
R1512	7030003380	S.RESISTOR ERJ3GGEYJ 331 V (330 Ω)	T
R1513	7030003380	S.RESISTOR ERJ3GGEYJ 331 V (330 Ω)	T
R1514	7030005321	S.RESISTOR ERA3YED 103V	T
R1515	7030005321	S.RESISTOR ERA3YED 103V	T
R1516	731 0002690	S.TRIMMER RV-145 (RH03A3A13X0CA) 102	T
R1517	7030005321	S.RESISTOR ERA3YED 103V	T
R1518	7030005321	S.RESISTOR ERA3YED 103V	T
R1519	7030005321	S.RESISTOR ERA3YED 103V	T
R1520	7030005321	S.RESISTOR ERA3YED 103V	T
R1521	7030010980	S.RESISTOR ERA3YHD 470V	T
R1522	7030009841	S.RESISTOR ERA3YHD 330V	T
R1523	7030009851	S.RESISTOR ERA3YED 271V	T
R1524	7030011050	S.RESISTOR ERA3YHD 100V	T
R1525	7030007230	S.RESISTOR ERA3YED 102V	B
R1526	7030003460	S.RESISTOR ERJ3GGEYJ 152 V (1.5 kΩ)	B
R1527	7030007230	S.RESISTOR ERA3YED 102V	T
R1528	7030007230	S.RESISTOR ERA3YED 102V	T
R1529	7030007230	S.RESISTOR ERA3YED 102V	T
R1530	7030003380	S.RESISTOR ERJ3GGEYJ 331 V (330 Ω)	T
R1531	7030003380	S.RESISTOR ERJ3GGEYJ 331 V (330 Ω)	T
R1532	7030005321	S.RESISTOR ERA3YED 103V	T
R1533	7030005321	S.RESISTOR ERA3YED 103V	T
R1534	7030005321	S.RESISTOR ERA3YED 103V	T
R1535	7030005321	S.RESISTOR ERA3YED 103V	T
R1536	7030005321	S.RESISTOR ERA3YED 103V	T
R1537	7030003320	S.RESISTOR ERJ3GGEYJ 101 V (100 Ω)	T
R1538	7030003320	S.RESISTOR ERJ3GGEYJ 101 V (100 Ω)	T
R1539	7030008061	S.RESISTOR ERA3YED 222V	B
R1540	7030010390	S.RESISTOR ERA3YED 821V	T
R1541	7030003320	S.RESISTOR ERJ3GGEYJ 101 V (100 Ω)	T
R1542	7030003320	S.RESISTOR ERJ3GGEYJ 101 V (100 Ω)	T
R1543	7030009691	S.RESISTOR ERA3YED 101V (100 Ω)	T
R1651	7030003380	S.RESISTOR ERJ3GGEYJ 331 V (330 Ω)	B
R1652	7030003220	S.RESISTOR ERJ3GGEYJ 150 V (15 Ω)	B
R1653	7030003380	S.RESISTOR ERJ3GGEYJ 331 V (330 Ω)	B
R1654	7030010980	S.RESISTOR ERA3YHD 470V	B
R1655	7030009861	S.RESISTOR ERA3YED 471V	B
R1656	7030003630	S.RESISTOR ERJ3GGEYJ 393 V (39 kΩ)	B
R1657	7030005871	S.RESISTOR ERA3YKD 104V (100 kΩ)	T
R1658	7030003320	S.RESISTOR ERJ3GGEYJ 101 V (100 Ω)	T
R1659	7030009691	S.RESISTOR ERA3YED 101V (100 Ω)	T
R1660	7030009691	S.RESISTOR ERA3YED 101V (100 Ω)	T
R1661	7030005321	S.RESISTOR ERA3YED 103V	T
R1662	7030005321	S.RESISTOR ERA3YED 103V	T
R1663	7030005321	S.RESISTOR ERA3YED 103V	T

[RXPLL-A UNIT]

REF NO.	ORDER NO.	DESCRIPTION	M.
R1664	7030005321	S.RESISTOR ERA3YED 103V	T
R1665	7030003320	S.RESISTOR ERJ3GGEYJ 101 V (100 Ω)	T
R1667	7030003360	S.RESISTOR ERJ3GGEYJ 221 V (220 Ω)	T
R1668	7030003360	S.RESISTOR ERJ3GGEYJ 221 V (220 Ω)	T
R1670	7030003800	S.RESISTOR ERJ3GGEYJ 105 V (1 MΩ)	T
R1673	7030007230	S.RESISTOR ERA3YED 102V	B
R1674	7030009591	S.RESISTOR ERA3YED 472V	B
R1675	7030009591	S.RESISTOR ERA3YED 472V	T
R1677	7030009591	S.RESISTOR ERA3YED 472V	T
R1701	7030003360	S.RESISTOR ERJ3GGEYJ 221 V (220 Ω)	T
R1703	7030003360	S.RESISTOR ERJ3GGEYJ 221 V (220 Ω)	T
R1704	7030003360	S.RESISTOR ERJ3GGEYJ 221 V (220 Ω)	T
R1706	7030003360	S.RESISTOR ERJ3GGEYJ 221 V (220 Ω)	T
R1707	7030003360	S.RESISTOR ERJ3GGEYJ 221 V (220 Ω)	T
R1708	7030003360	S.RESISTOR ERJ3GGEYJ 221 V (220 Ω)	T
R1709	7030003480	S.RESISTOR ERJ3GGEYJ 222 V (2.2 kΩ)	T
R1710	7030003480	S.RESISTOR ERJ3GGEYJ 222 V (2.2 kΩ)	T
R1711	7030003540	S.RESISTOR ERJ3GGEYJ 682 V (6.8 kΩ)	T
R1712	7030003540	S.RESISTOR ERJ3GGEYJ 682 V (6.8 kΩ)	T
R1713	7030003660	S.RESISTOR ERJ3GGEYJ 683 V (68 kΩ)	T
R1714	7030003660	S.RESISTOR ERJ3GGEYJ 683 V (68 kΩ)	T
R1716	7030007230	S.RESISTOR ERA3YED 102V	T
R1717	7030007230	S.RESISTOR ERA3YED 102V	T
R1718	7030007230	S.RESISTOR ERA3YED 102V	T
C1	4030011600	S.CERAMIC C1608 JB 1E 104K-T	T
C2	4030006880	S.CERAMIC C1608 JB 1H 472K-T	T
C14	4030006880	S.CERAMIC C1608 JB 1H 472K-T	T
C15	4030006880	S.CERAMIC C1608 JB 1H 472K-T	T
C16	4030006880	S.CERAMIC C1608 JB 1H 472K-T	T
C17	4030006880	S.CERAMIC C1608 JB 1H 472K-T	T
C18	4030006880	S.CERAMIC C1608 JB 1H 472K-T	T
C19	4030006880	S.CERAMIC C1608 JB 1H 472K-T	T
C20	4030006880	S.CERAMIC C1608 JB 1H 472K-T	T
C21	4030006880	S.CERAMIC C1608 JB 1H 472K-T	T
C22	4030006880	S.CERAMIC C1608 JB 1H 472K-T	T
C30	4030011600	S.CERAMIC C1608 JB 1E 104K-T	T
C31	4030011600	S.CERAMIC C1608 JB 1E 104K-T	T
C32	4030011600	S.CERAMIC C1608 JB 1E 104K-T	T
C51	4510004640	S.ELECTROLYTIC ECEV1CA470SP	T
C52	4030011600	S.CERAMIC C1608 JB 1E 104K-T	T
C53	4030011600	S.CERAMIC C1608 JB 1E 104K-T	T
C54	4510006220	S.ELECTROLYTIC ECEV1CA101UP	T
C61	4510004640	S.ELECTROLYTIC ECEV1CA470SP	T
C62	4030011600	S.CERAMIC C1608 JB 1E 104K-T	B
C63	4030011600	S.CERAMIC C1608 JB 1E 104K-T	B
C64	4510006220	S.ELECTROLYTIC ECEV1CA101UP	T
C101	4030006880	S.CERAMIC C1608 JB 1H 472K-T	T
C102	4030011600	S.CERAMIC C1608 JB 1E 104K-T	T
C103	4510004630	S.ELECTROLYTIC ECEV1CA100SR	T
C104	4030011600	S.CERAMIC C1608 JB 1E 104K-T	T
C105	4030011600	S.CERAMIC C1608 JB 1E 104K-T	T
C106	4030011600	S.CERAMIC C1608 JB 1E 104K-T	T
C107	4030011600	S.CERAMIC C1608 JB 1E 104K-T	T
C108	4030011600	S.CERAMIC C1608 JB 1E 104K-T	T
C109	4030011600	S.CERAMIC C1608 JB 1E 104K-T	T
C110	4030011600	S.CERAMIC C1608 JB 1E 104K-T	T
C111	4030011600	S.CERAMIC C1608 JB 1E 104K-T	T
C112	4030011600	S.CERAMIC C1608 JB 1E 104K-T	T
C114	4030011600	S.CERAMIC C1608 JB 1E 104K-T	T
C115	4030011600	S.CERAMIC C1608 JB 1E 104K-T	T
C116	4030011600	S.CERAMIC C1608 JB 1E 104K-T	T
C117	4030011600	S.CERAMIC C1608 JB 1E 104K-T	T
C118	4030011600	S.CERAMIC C1608 JB 1E 104K-T	T
C119	4030011600	S.CERAMIC C1608 JB 1E 104K-T	B
C120	4030006880	S.CERAMIC C1608 JB 1H 472K-T	T
C121	4030011600	S.CERAMIC C1608 JB 1E 104K-T	T
C125	4030011600	S.CERAMIC C1608 JB 1E 104K-T	T
C129	4030011600	S.CERAMIC C1608 JB 1E 104K-T	T
C130	4030017810	S.CERAMIC C1608 CH 1H 102J-T	B
C131	4030011600	S.CERAMIC C1608 JB 1E 104K-T	T
C132	4030011600	S.CERAMIC C1608 JB 1E 104K-T	T
C133	4030006880	S.CERAMIC C1608 JB 1H 472K-T	B
C134	4030006880	S.CERAMIC C1608 JB 1H 472K-T	B
C135	4030006880	S.CERAMIC C1608 JB 1H 472K-T	T
C136	4030006880	S.CERAMIC C1608 JB 1H 472K-T	T
C137	4030006880	S.CERAMIC C1608 JB 1H 472K-T	T
C138	4030006880	S.CERAMIC C1608 JB 1H 472K-T	T
C139	4030006880	S.CERAMIC C1608 JB 1H 472K-T	B
C140	4030006880	S.CERAMIC C1608 JB 1H 472K-T	B
C150	4030006880	S.CERAMIC C1608 JB 1H 472K-T	B
C151	4550006700	S.TANTALUM ECST1AY106R	B
C152	4030007070	S.CERAMIC C1608 CH 1H 330J-T	T
C153	4030009910	S.CERAMIC C1608 CH 1H 040B-T	T
C154	4610001850	S.TRIMMER TZB4R200AB10R00	T
C155	4030016550	S.CERAMIC CM105 CH 151G 50AT	T
C156	4030016550	S.CERAMIC CM105 CH 151G 50AT	T

M.=Mounted side (T: Mounted on the Top side, B: Mounted on the Bottom side)

S.=Surface mount

[RXPLL-A UNIT]

REF NO.	ORDER NO.	DESCRIPTION	M.
C157	4030016550	S.CERAMIC CM105 CH 151 G 50AT	T
C158	4030006880	S.CERAMIC C1608 JB 1H 472K-T	T
C159	4030006880	S.CERAMIC C1608 JB 1H 472K-T	B
C161	4510004630	S.ELECTROLYTIC ECEV1CA100SR	T
C162	4030009920	S.CERAMIC C1608 CH 1H 050B-T	B
C163	4030011600	S.CERAMIC C1608 JB 1E 104K-T	B
C164	4030006880	S.CERAMIC C1608 JB 1H 472K-T	B
C165	4030006880	S.CERAMIC C1608 JB 1H 472K-T	B
C166	4030011600	S.CERAMIC C1608 JB 1E 104K-T	B
C167	4030006880	S.CERAMIC C1608 JB 1H 472K-T	B
C201	4030011340	S.CERAMIC C1608 CH 1H 471J-T	T
C202	4510004650	S.ELECTROLYTIC ECEV1EA4R7SR	T
C203	4030006900	S.CERAMIC C1608 JB 1H 103K-T	T
C204	4030006880	S.CERAMIC C1608 JB 1H 472K-T	T
C205	4030006880	S.CERAMIC C1608 JB 1H 472K-T	T
C206	4030006880	S.CERAMIC C1608 JB 1H 472K-T	T
C207	4030007030	S.CERAMIC C1608 CH 1H 150J-T	B
C208	4030007030	S.CERAMIC C1608 CH 1H 150J-T	T
C210	4550006590	S.TANTALUM ECST1CY684R	T
C213	4030006880	S.CERAMIC C1608 JB 1H 472K-T	T
C214	4030006900	S.CERAMIC C1608 JB 1H 103K-T	T
C215	4510004630	S.ELECTROLYTIC ECEV1CA100SR	T
C216	4550006300	S.TANTALUM ECST1AY475R	T
C217	4550006300	S.TANTALUM ECST1AY475R	T
C220	4030007120	S.CERAMIC C1608 CH 1H 820J-T	T
C221	4030007010	S.CERAMIC C1608 CH 1H 100D-T	T
C222	4610001160	S.TRIMMER ECR-JA010 A11W	T
C223	4030007080	S.CERAMIC C1608 CH 1H 390J-T	T
C224	4030007030	S.CERAMIC C1608 CH 1H 150J-T	T
C225	4030007010	S.CERAMIC C1608 CH 1H 100D-T	T
C226	4030006880	S.CERAMIC C1608 JB 1H 472K-T	T
C227	4030009520	S.CERAMIC C1608 CH 1H 020B-T	T
C228	4510004630	S.ELECTROLYTIC ECEV1CA100SR	T
C230	4030007090	S.CERAMIC C1608 CH 1H 470J-T	T
C231	4030009920	S.CERAMIC C1608 CH 1H 050B-T	T
C232	4610001160	S.TRIMMER ECR-JA010 A11W	T
C233	4030007070	S.CERAMIC C1608 CH 1H 330J-T	T
C234	4030007020	S.CERAMIC C1608 CH 1H 120J-T	T
C235	4030009920	S.CERAMIC C1608 CH 1H 050B-T	T
C236	4030006880	S.CERAMIC C1608 JB 1H 472K-T	T
C237	4030009520	S.CERAMIC C1608 CH 1H 020B-T	T
C238	4510004630	S.ELECTROLYTIC ECEV1CA100SR	T
C240	4030007080	S.CERAMIC C1608 CH 1H 390J-T	T
C241	4030009920	S.CERAMIC C1608 CH 1H 050B-T	T
C242	4540000090	S.TRIMMER ECR-JA006A11W	T
C243	4030007060	S.CERAMIC C1608 CH 1H 270J-T	T
C244	4030007010	S.CERAMIC C1608 CH 1H 100D-T	T
C245	4030006980	S.CERAMIC C1608 CH 1H 070D-T	T
C246	4030006880	S.CERAMIC C1608 JB 1H 472K-T	T
C247	4030009520	S.CERAMIC C1608 CH 1H 020B-T	T
C248	4510004630	S.ELECTROLYTIC ECEV1CA100SR	T
C250	4030007070	S.CERAMIC C1608 CH 1H 330J-T	T
C251	4030009510	S.CERAMIC C1608 CH 1H 010B-T	T
C252	4540000090	S.TRIMMER ECR-JA006A11W	T
C253	4030007080	S.CERAMIC C1608 CH 1H 390J-T	T
C254	4030009920	S.CERAMIC C1608 CH 1H 050B-T	T
C255	4030009530	S.CERAMIC C1608 CH 1H 030B-T	T
C256	4030006880	S.CERAMIC C1608 JB 1H 472K-T	T
C257	4030009520	S.CERAMIC C1608 CH 1H 020B-T	T
C258	4510004630	S.ELECTROLYTIC ECEV1CA100SR	T
C260	4030007110	S.CERAMIC C1608 CH 1H 680J-T	T
C261	4030009910	S.CERAMIC C1608 CH 1H 040B-T	T
C262	4540000090	S.TRIMMER ECR-JA006A11W	T
C263	4030007080	S.CERAMIC C1608 CH 1H 390J-T	T
C264	4030009920	S.CERAMIC C1608 CH 1H 050B-T	T
C265	4030007010	S.CERAMIC C1608 CH 1H 100D-T	T
C266	4030006880	S.CERAMIC C1608 JB 1H 472K-T	T
C267	4030009920	S.CERAMIC C1608 CH 1H 050B-T	T
C268	4510004630	S.ELECTROLYTIC ECEV1CA100SR	T
C270	4030007080	S.CERAMIC C1608 CH 1H 390J-T	T
C272	4540000090	S.TRIMMER ECR-JA006A11W	T
C273	4030007070	S.CERAMIC C1608 CH 1H 330J-T	T
C274	4030006980	S.CERAMIC C1608 CH 1H 070D-T	T
C275	4030009530	S.CERAMIC C1608 CH 1H 030B-T	T
C276	4030006880	S.CERAMIC C1608 JB 1H 472K-T	T
C277	4030009530	S.CERAMIC C1608 CH 1H 030B-T	T
C278	4510004630	S.ELECTROLYTIC ECEV1CA100SR	T
C283	4030017810	S.CERAMIC C1608 CH 1H 102J-T	T
C284	4030006880	S.CERAMIC C1608 JB 1H 472K-T	T
C285	4030017810	S.CERAMIC C1608 CH 1H 102J-T	T
C286	4030006880	S.CERAMIC C1608 JB 1H 472K-T	T
C287	4030017810	S.CERAMIC C1608 CH 1H 102J-T	T
C288	4030006880	S.CERAMIC C1608 JB 1H 472K-T	T
C289	4030017810	S.CERAMIC C1608 CH 1H 102J-T	T
C290	4030006880	S.CERAMIC C1608 JB 1H 472K-T	T
C291	4030017810	S.CERAMIC C1608 CH 1H 102J-T	T
C292	4030006880	S.CERAMIC C1608 JB 1H 472K-T	T
C293	4030017810	S.CERAMIC C1608 CH 1H 102J-T	T

M.=Mounted side (T: Mounted on the Top side, B: Mounted on the Bottom side)

[RXPLL-A UNIT]

REF NO.	ORDER NO.	DESCRIPTION	M.
C294	4030006880	S.CERAMIC C1608 JB 1H 472K-T	T
C301	4030006880	S.CERAMIC C1608 JB 1H 472K-T	T
C302	4030006880	S.CERAMIC C1608 JB 1H 472K-T	T
C303	4030006880	S.CERAMIC C1608 JB 1H 472K-T	B
C304	4030006880	S.CERAMIC C1608 JB 1H 472K-T	B
C305	4030006880	S.CERAMIC C1608 JB 1H 472K-T	B
C306	4030006880	S.CERAMIC C1608 JB 1H 472K-T	B
C309	4030017810	S.CERAMIC C1608 CH 1H 102J-T	T
C310	4030011600	S.CERAMIC C1608 JB 1E 104K-T	T
C311	4510004640	S.ELECTROLYTIC ECEV1CA470SP	T
C331	4030007110	S.CERAMIC C1608 CH 1H 680J-T	T
C332	4030007160	S.CERAMIC C1608 CH 1H 181J-T	T
C333	4030007110	S.CERAMIC C1608 CH 1H 680J-T	T
C334	4030007050	S.CERAMIC C1608 CH 1H 220J-T	T
C335	4030006980	S.CERAMIC C1608 CH 1H 070D-T	T
C336	4030007030	S.CERAMIC C1608 CH 1H 150J-T	T
C337	4030007050	S.CERAMIC C1608 CH 1H 220J-T	T
C341	4030006880	S.CERAMIC C1608 JB 1H 472K-T	T
C342	4030006880	S.CERAMIC C1608 JB 1H 472K-T	T
C344	4030011600	S.CERAMIC C1608 JB 1E 104K-T	T
C351	4030017810	S.CERAMIC C1608 CH 1H 102J-T	T
C352	4030011600	S.CERAMIC C1608 JB 1E 104K-T	T
C353	4510004640	S.ELECTROLYTIC ECEV1CA470SP	T
C354	4030006880	S.CERAMIC C1608 JB 1H 472K-T	T
C355	4030006880	S.CERAMIC C1608 JB 1H 472K-T	T
C356	4030006880	S.CERAMIC C1608 JB 1H 472K-T	T
C357	4030006880	S.CERAMIC C1608 JB 1H 472K-T	T
C358	4030006880	S.CERAMIC C1608 JB 1H 472K-T	B
C359	4030006880	S.CERAMIC C1608 JB 1H 472K-T	B
C360	4030006880	S.CERAMIC C1608 JB 1H 472K-T	B
C361	4030006880	S.CERAMIC C1608 JB 1H 472K-T	T
C363	4030006880	S.CERAMIC C1608 JB 1H 472K-T	T
C364	4030017810	S.CERAMIC C1608 CH 1H 102J-T	T
C365	4030006880	S.CERAMIC C1608 JB 1H 472K-T	T
C421	4030006880	S.CERAMIC C1608 JB 1H 472K-T	T
C422	4030006880	S.CERAMIC C1608 JB 1H 472K-T	T
C423	4030006880	S.CERAMIC C1608 JB 1H 472K-T	T
C424	4030006880	S.CERAMIC C1608 JB 1H 472K-T	T
C425	4030006880	S.CERAMIC C1608 JB 1H 472K-T	T
C426	4030006880	S.CERAMIC C1608 JB 1H 472K-T	B
C427	4030006880	S.CERAMIC C1608 JB 1H 472K-T	T
C428	4030006880	S.CERAMIC C1608 JB 1H 472K-T	T
C441	4030007040	S.CERAMIC C1608 CH 1H 180J-T	T
C442	4030007040	S.CERAMIC C1608 CH 1H 180J-T	T
C443	4030007020	S.CERAMIC C1608 CH 1H 120J-T	T
C444	4030007080	S.CERAMIC C1608 CH 1H 390J-T	T
C445	4030011770	S.CERAMIC C1608 CH 1H 060B-T	T
C446	4030007060	S.CERAMIC C1608 CH 1H 270J-T	T
C447	4030007110	S.CERAMIC C1608 CH 1H 680J-T	T
C448	4030006880	S.CERAMIC C1608 JB 1H 472K-T	T
C449	4030006880	S.CERAMIC C1608 JB 1H 472K-T	T
C451	4030007110	S.CERAMIC C1608 CH 1H 680J-T	T
C452	4030007160	S.CERAMIC C1608 CH 1H 181J-T	T
C453	4030011600	S.CERAMIC C1608 JB 1E 104K-T	T
C501	4030006880	S.CERAMIC C1608 JB 1H 472K-T	T
C502	4030011600	S.CERAMIC C1608 JB 1E 104K-T	T
C503	4510004630	S.ELECTROLYTIC ECEV1CA100SR	T
C504	4030011600	S.CERAMIC C1608 JB 1E 104K-T	T
C506	4030011600	S.CERAMIC C1608 JB 1E 104K-T	T
C507	4030011600	S.CERAMIC C1608 JB 1E 104K-T	T
C509	4030011600	S.CERAMIC C1608 JB 1E 104K-T	T
C510	4030011600	S.CERAMIC C1608 JB 1E 104K-T	T
C511	4030011600	S.CERAMIC C1608 JB 1E 104K-T	T
C512	4030011600	S.CERAMIC C1608 JB 1E 104K-T	T
C513	4030011600	S.CERAMIC C1608 JB 1E 104K-T	T
C514	4030011600	S.CERAMIC C1608 JB 1E 104K-T	T
C515	4030011600	S.CERAMIC C1608 JB 1E 104K-T	T
C516	4030011600	S.CERAMIC C1608 JB 1E 104K-T	T
C517	4030011600	S.CERAMIC C1608 JB 1E 104K-T	T
C518	4030011600	S.CERAMIC C1608 JB 1E 104K-T	T
C519	4030011600	S.CERAMIC C1608 JB 1E 104K-T	T
C520	4030011600	S.CERAMIC C1608 JB 1E 104K-T	T
C521	4030011600	S.CERAMIC C1608 JB 1E 104K-T	T
C525	4030006880	S.CERAMIC C1608 JB 1H 472K-T	T
C526	4030011600	S.CERAMIC C1608 JB 1E 104K-T	T
C531	4030006880	S.CERAMIC C1608 JB 1H 472K-T	T
C532	4030007070	S.CERAMIC C1608 CH 1H 330J-T	T
C533	4030007110	S.CERAMIC C1608 CH 1H 680J-T	T
C534	4030007110	S.CERAMIC C1608 CH 1H 680J-T	T
C535	4030007070	S.CERAMIC C1608 CH 1H 330J-T	T
C536	4030006880	S.CERAMIC C1608 JB 1H 472K-T	T
C537	4030006880	S.CERAMIC C1608 JB 1H 472K-T	T
C540	4030006880	S.CERAMIC C1608 JB 1H 472K-T	B
C541	4510004630	S.ELECTROLYTIC ECEV1CA100SR	T
C542	4340000260	S.MYLAR ECPU 1C 104MA5	B
C543	4030007050	S.CERAMIC C1608 CH 1H 220J-T	T
C545	4030007060	S.CERAMIC C1608 CH 1H 270J-T	T
C546	4610001160	S.TRIMMER ECR-JA010 A11W	T

S.=Surface mount

[RXPLL-A UNIT]

REF NO.	ORDER NO.	DESCRIPTION	M.
C547	4030007130	S.CERAMIC C1608 CH 1H 101J-T	T
C548	4030007030	S.CERAMIC C1608 CH 1H 150J-T	T
C549	4030007020	S.CERAMIC C1608 CH 1H 120J-T	T
C550	4030006880	S.CERAMIC C1608 JB 1H 472K-T	T
C551	4030009510	S.CERAMIC C1608 CH 1H 010B-T	T
C552	4030017810	S.CERAMIC C1608 CH 1H 102J-T	B
C553	4030006880	S.CERAMIC C1608 JB 1H 472K-T	B
C554	4510006220	S.ELECTROLYTIC ECEV1CA101UP	T
C555	4030006880	S.CERAMIC C1608 JB 1H 472K-T	B
C558	4550006300	S.TANTALUM ECST1AY475R	B
C559	4550006590	S.TANTALUM ECST1CY684R	B
C562	4030006880	S.CERAMIC C1608 JB 1H 472K-T	T
C563	4030017810	S.CERAMIC C1608 CH 1H 102J-T	T
C564	4030006880	S.CERAMIC C1608 JB 1H 472K-T	B
C565	4510004640	S.ELECTROLYTIC ECEV1CA470SP	T
C566	4030006880	S.CERAMIC C1608 JB 1H 472K-T	T
C571	4030006880	S.CERAMIC C1608 JB 1H 472K-T	B
C573	4030007040	S.CERAMIC C1608 CH 1H 180J-T	T
C574	4030009510	S.CERAMIC C1608 CH 1H 010B-T	T
C575	4030007040	S.CERAMIC C1608 CH 1H 180J-T	T
C580	4030006880	S.CERAMIC C1608 JB 1H 472K-T	T
C581	4030006880	S.CERAMIC C1608 JB 1H 472K-T	T
C591	4030006880	S.CERAMIC C1608 JB 1H 472K-T	T
C592	4030007060	S.CERAMIC C1608 CH 1H 270J-T	T
C593	4510004630	S.ELECTROLYTIC ECEV1CA100SR	T
C594	4030006880	S.CERAMIC C1608 JB 1H 472K-T	T
C596	4030006880	S.CERAMIC C1608 JB 1H 472K-T	B
C597	4030007050	S.CERAMIC C1608 CH 1H 220J-T	T
C604	4030011600	S.CERAMIC C1608 JB 1E 104K-T	B
C605	4510004630	S.ELECTROLYTIC ECEV1CA100SR	T
C651	4030006880	S.CERAMIC C1608 JB 1H 472K-T	T
C652	4030011600	S.CERAMIC C1608 JB 1E 104K-T	T
C653	4510004630	S.ELECTROLYTIC ECEV1CA100SR	T
C654	4030011600	S.CERAMIC C1608 JB 1E 104K-T	T
C655	4030011600	S.CERAMIC C1608 JB 1E 104K-T	T
C656	4030011600	S.CERAMIC C1608 JB 1E 104K-T	T
C657	4030011600	S.CERAMIC C1608 JB 1E 104K-T	T
C658	4030011600	S.CERAMIC C1608 JB 1E 104K-T	T
C659	4030011600	S.CERAMIC C1608 JB 1E 104K-T	T
C660	4030006880	S.CERAMIC C1608 JB 1H 472K-T	T
C661	4030011600	S.CERAMIC C1608 JB 1E 104K-T	T
C680	4030006880	S.CERAMIC C1608 JB 1H 472K-T	T
C681	4030011340	S.CERAMIC C1608 CH 1H 471J-T	T
C682	4030007120	S.CERAMIC C1608 CH 1H 820J-T	T
C683	4030017870	S.CERAMIC C1608 CH 1H 681J-T	T
C684	4030007070	S.CERAMIC C1608 CH 1H 330J-T	B
C685	4030017800	S.CERAMIC C1608 CH 1H 561J-T	B
C686	4030011280	S.CERAMIC C1608 CH 1H 271J-T	B
C687	4030017810	S.CERAMIC C1608 CH 1H 102J-T	T
C688	4030011280	S.CERAMIC C1608 CH 1H 271J-T	B
C689	4030011600	S.CERAMIC C1608 JB 1E 104K-T	T
C690	4030011600	S.CERAMIC C1608 JB 1E 104K-T	T
C691	4030011600	S.CERAMIC C1608 JB 1E 104K-T	T
C692	4030006880	S.CERAMIC C1608 JB 1H 472K-T	T
C693	4030006880	S.CERAMIC C1608 JB 1H 472K-T	B
C694	4030006880	S.CERAMIC C1608 JB 1H 472K-T	B
C703	4030017810	S.CERAMIC C1608 CH 1H 102J-T	T
C704	4030006880	S.CERAMIC C1608 JB 1H 472K-T	T
C705	4510006220	S.ELECTROLYTIC ECEV1CA101UP	T
C707	4030011600	S.CERAMIC C1608 JB 1E 104K-T	T
C708	4030011600	S.CERAMIC C1608 JB 1E 104K-T	T
C709	4030007070	S.CERAMIC C1608 CH 1H 330J-T	T
C710	4030006880	S.CERAMIC C1608 JB 1H 472K-T	T
C711	4030009540	S.CERAMIC C1608 CH 1H 1R5B-T	B
C712	4030007070	S.CERAMIC C1608 CH 1H 330J-T	T
C713	4030006880	S.CERAMIC C1608 JB 1H 472K-T	T
C801	4030006880	S.CERAMIC C1608 JB 1H 472K-T	T
C802	4030007030	S.CERAMIC C1608 CH 1H 150J-T	T
C803	4030006900	S.CERAMIC C1608 JB 1H 103K-T	T
C811	4030011600	S.CERAMIC C1608 JB 1E 104K-T	T
C812	4030011600	S.CERAMIC C1608 JB 1E 104K-T	T
C813	4030017800	S.CERAMIC C1608 CH 1H 561J-T	T
C831	4030009910	S.CERAMIC C1608 CH 1H 040B-T	T
C832	4030009510	S.CERAMIC C1608 CH 1H 010B-T	T
C834	4030007030	S.CERAMIC C1608 CH 1H 150J-T	T
C835	4030006900	S.CERAMIC C1608 JB 1H 103K-T	T
C836	4510004630	S.ELECTROLYTIC ECEV1CA100SR	T
C837	4030006880	S.CERAMIC C1608 JB 1H 472K-T	T
C838	4030007020	S.CERAMIC C1608 CH 1H 120J-T	T
C1000	4030007050	S.CERAMIC C1608 CH 1H 220J-T	B
C1001	4030007170	S.CERAMIC C1608 CH 1H 221J-T	T
C1002	4030006880	S.CERAMIC C1608 JB 1H 472K-T	B
C1003	4030012600	S.CERAMIC C2012 JB 1A 105M-T	T
C1004	4030011600	S.CERAMIC C1608 JB 1E 104K-T	B
C1005	4030011600	S.CERAMIC C1608 JB 1E 104K-T	T
C1006	4030010210	S.CERAMIC C3216 JB 1C 105M-T	T
C1007	4030006880	S.CERAMIC C1608 JB 1H 472K-T	T
C1008	4030006880	S.CERAMIC C1608 JB 1H 472K-T	T

M.-Mounted side (T: Mounted on the Top side, B: Mounted on the Bottom side)

[RXPLL-A UNIT]

REF NO.	ORDER NO.	DESCRIPTION	M.
C1009	4030006880	S.CERAMIC C1608 JB 1H 472K-T	T
C1010	4030012600	S.CERAMIC C2012 JB 1A 105M-T	T
C1011	4030012600	S.CERAMIC C2012 JB 1A 105M-T	T
C1012	4030010210	S.CERAMIC C3216 JB 1C 105M-T	T
C1013	4030012600	S.CERAMIC C2012 JB 1A 105M-T	T
C1014	4030018810	S.CERAMIC C3216 CH 1H 333J-T	B
C1015	4030012600	S.CERAMIC C2012 JB 1A 105M-T	T
C1016	4030012600	S.CERAMIC C2012 JB 1A 105M-T	T
C1017	4030012600	S.CERAMIC C2012 JB 1A 105M-T	T
C1018	4030012600	S.CERAMIC C2012 JB 1A 105M-T	T
C1019	4030012600	S.CERAMIC C2012 JB 1A 105M-T	T
C1020	4030012600	S.CERAMIC C2012 JB 1A 105M-T	B
C1021	4030012600	S.CERAMIC C2012 JB 1A 105M-T	B
C1022	4030006990	S.CERAMIC C1608 CH 1H 080D-T	B
C1023	4030006990	S.CERAMIC C1608 CH 1H 080D-T	B
C1024	4030010210	S.CERAMIC C3216 JB 1C 105M-T	B
C1025	4030010210	S.CERAMIC C3216 JB 1C 105M-T	B
C1026	4030010210	S.CERAMIC C3216 JB 1C 105M-T	T
C1027	4030010210	S.CERAMIC C3216 JB 1C 105M-T	T
C1028	4030006880	S.CERAMIC C1608 JB 1H 472K-T	B
C1029	4030006880	S.CERAMIC C1608 JB 1H 472K-T	T
C1030	4030010210	S.CERAMIC C3216 JB 1C 105M-T	T
C1031	4030012600	S.CERAMIC C2012 JB 1A 105M-T	B
C1032	4030011600	S.CERAMIC C1608 JB 1E 104K-T	B
C1033	4550006470	S.TANTALUM TEESVB2 1D 106M8L	B
C1034	4550006470	S.TANTALUM TEESVB2 1D 106M8L	B
C1035	4550006470	S.TANTALUM TEESVB2 1D 106M8L	B
C1036	4030007120	S.CERAMIC C1608 CH 1H 820J-T	T
C1037	4030007090	S.CERAMIC C1608 CH 1H 470J-T	B
C1038	4030017810	S.CERAMIC C1608 CH 1H 102J-T	T
C1039	4030017810	S.CERAMIC C1608 CH 1H 102J-T	T
C1040	4030017810	S.CERAMIC C1608 CH 1H 102J-T	T
C1041	4030006990	S.CERAMIC C1608 CH 1H 080D-T	B
C1048	4030017180	S.CERAMIC UMK107 B 102K Z-T	B
C1049	4030017180	S.CERAMIC UMK107 B 102K Z-T	B
C1050	4030017180	S.CERAMIC UMK107 B 102K Z-T	B
C1051	4030017180	S.CERAMIC UMK107 B 102K Z-T	B
C1052	4030007100	S.CERAMIC C1608 CH 1H 560J-T	T
C1053	4030007110	S.CERAMIC C1608 CH 1H 680J-T	T
C1054	4030007010	S.CERAMIC C1608 CH 1H 100D-T	B
C1055	4030007140	S.CERAMIC C1608 CH 1H 121J-T	B
C1056	4030007050	S.CERAMIC C1608 CH 1H 220J-T	T
C1057	4030007130	S.CERAMIC C1608 CH 1H 101J-T	T
C1060	4030017810	S.CERAMIC C1608 CH 1H 102J-T	T
C1061	4030007090	S.CERAMIC C1608 CH 1H 470J-T	B
C1062	4030007170	S.CERAMIC C1608 CH 1H 221J-T	B
C1063	4030007000	S.CERAMIC C1608 CH 1H 090D-T	B
C1064	4030007090	S.CERAMIC C1608 CH 1H 470J-T	T
C1066	4030007070	S.CERAMIC C1608 CH 1H 330J-T	T
C1067	4030007010	S.CERAMIC C1608 CH 1H 100D-T	T
C1071	4030007100	S.CERAMIC C1608 CH 1H 560J-T	B
C1072	4030007170	S.CERAMIC C1608 CH 1H 221J-T	B
C1073	4030007080	S.CERAMIC C1608 CH 1H 390J-T	T
C1081	4030006900	S.CERAMIC C1608 JB 1H 103K-T	B
C1082	4030006900	S.CERAMIC C1608 JB 1H 103K-T	B
C1083	4030006900	S.CERAMIC C1608 JB 1H 103K-T	B
C1084	4030006880	S.CERAMIC C1608 JB 1H 472K-T	B
C1085	4030006880	S.CERAMIC C1608 JB 1H 472K-T	B
C1091	4030006880	S.CERAMIC C1608 JB 1H 472K-T	T
C1092	4030006880	S.CERAMIC C1608 JB 1H 472K-T	T
C1093	4030006880	S.CERAMIC C1608 JB 1H 472K-T	T
C1101	4030006900	S.CERAMIC C1608 JB 1H 103K-T	T
C1102	4030006900	S.CERAMIC C1608 JB 1H 103K-T	T
C1103	4030011600	S.CERAMIC C1608 JB 1E 104K-T	T
C1104	4030011600	S.CERAMIC C1608 JB 1E 104K-T	T
C1106	4030011600	S.CERAMIC C1608 JB 1E 104K-T	T
C1107	4030011600	S.CERAMIC C1608 JB 1E 104K-T	B
C1109	4030007090	S.CERAMIC C1608 CH 1H 470J-T	T
C1110	4030006900	S.CERAMIC C1608 JB 1H 103K-T	T
C1111	4030011600	S.CERAMIC C1608 JB 1E 104K-T	T
C1112	4030006900	S.CERAMIC C1608 JB 1H 103K-T	T
C1113	4030007010	S.CERAMIC C1608 CH 1H 100D-T	T
C1114	4030006900	S.CERAMIC C1608 CH 1H 103K-T	B
C1115	4030011600	S.CERAMIC C1608 JB 1E 104K-T	T
C1116	4030006900	S.CERAMIC C1608 JB 1H 103K-T	T
C1117	4030007010	S.CERAMIC C1608 CH 1H 100D-T	T
C1118	4030011600	S.CERAMIC C1608 JB 1E 104K-T	T
C1119	4030006880	S.CERAMIC C1608 JB 1H 472K-T	T
C1120	4030006880	S.CERAMIC C1608 JB 1H 472K-T	T
C1121	4030011600	S.CERAMIC C1608 JB 1E 104K-T	T
C1122	4030009530	S.CERAMIC C1608 CH 1H 030B-T	T
C1123	4030006900	S.CERAMIC C1608 JB 1H 103K-T	T
C1124	4030006900	S.CERAMIC C1608 JB 1H 103K-T	T
C1125	4030006900	S.CERAMIC C1608 JB 1H 103K-T	T
C1126	4030011600	S.CERAMIC C1608 JB 1E 104K-T	T
C1207	4030006880	S.CERAMIC C1608 JB 1H 472K-T	B
C1214	4030007170	S.CERAMIC C1608 CH 1H 221J-T	T
C1215	4030011600	S.CERAMIC C1608 JB 1E 104K-T	T

S.-Surface mount

[RXPLL-A UNIT]

REF NO.	ORDER NO.	DESCRIPTION	M.
C1231	4030006900	S.CERAMIC C1608 JB 1H 103K-T	T
C1232	4030006900	S.CERAMIC C1608 JB 1H 103K-T	T
C1233	4030006900	S.CERAMIC C1608 JB 1H 103K-T	T
C1234	4030006900	S.CERAMIC C1608 JB 1H 103K-T	B
C1235	4030006880	S.CERAMIC C1608 JB 1H 472K-T	T
C1236	4030006900	S.CERAMIC C1608 JB 1H 103K-T	T
C1237	4030006900	S.CERAMIC C1608 JB 1H 103K-T	T
C1238	4030006900	S.CERAMIC C1608 JB 1H 103K-T	B
C1239	4030006880	S.CERAMIC C1608 JB 1H 472K-T	B
C1240	4030006900	S.CERAMIC C1608 JB 1H 103K-T	T
C1241	4030006900	S.CERAMIC C1608 JB 1H 103K-T	T
C1243	4030006880	S.CERAMIC C1608 JB 1H 472K-T	T
C1244	4030007080	S.CERAMIC C1608 CH 1H 390J-T	T
C1245	4030007130	S.CERAMIC C1608 CH 1H 101J-T	T
C1246	4030007120	S.CERAMIC C1608 CH 1H 820J-T	T
C1247	4030007090	S.CERAMIC C1608 CH 1H 470J-T	T
C1248	4030007130	S.CERAMIC C1608 CH 1H 101J-T	T
C1249	4030007020	S.CERAMIC C1608 CH 1H 120J-T	T
C1250	4030007100	S.CERAMIC C1608 CH 1H 560J-T	B
C1251	4030006900	S.CERAMIC C1608 JB 1H 103K-T	T
C1252	4030006900	S.CERAMIC C1608 JB 1H 103K-T	T
C1253	4030006900	S.CERAMIC C1608 JB 1H 103K-T	B
C1254	4030006900	S.CERAMIC C1608 CH 1H 080D-T	T
C1255	4030006900	S.CERAMIC C1608 JB 1H 103K-T	B
C1264	4030007110	S.CERAMIC C1608 CH 1H 680J-T	T
C1265	4610001160	S.TRIMMER ECR-JA010 A11W	T
C1266	4030007020	S.CERAMIC C1608 CH 1H 120J-T	T
C1267	4030006880	S.CERAMIC C1608 JB 1H 472K-T	B
C1268	4030006980	S.CERAMIC C1608 CH 1H 070D-T	T
C1301	4030006990	S.CERAMIC C1608 CH 1H 080D-T	T
C1302	4030007060	S.CERAMIC C1608 CH 1H 270J-T	T
C1303	4030006980	S.CERAMIC C1608 CH 1H 070D-T	T
C1304	4030007070	S.CERAMIC C1608 CH 1H 330J-T	T
C1305	4030007010	S.CERAMIC C1608 CH 1H 100D-T	T
C1306	4030009650	S.CERAMIC C1608 CH 1H 240J-T	T
C1307	4030007030	S.CERAMIC C1608 CH 1H 150J-T	T
C1308	4030006900	S.CERAMIC C1608 JB 1H 103K-T	T
C1309	4030007080	S.CERAMIC C1608 CH 1H 390J-T	T
C1310	4030007080	S.CERAMIC C1608 CH 1H 390J-T	T
C1311	4030006900	S.CERAMIC C1608 JB 1H 103K-T	B
C1312	4030007060	S.CERAMIC C1608 CH 1H 270J-T	T
C1313	4030007060	S.CERAMIC C1608 CH 1H 270J-T	T
C1355	4030006880	S.CERAMIC C1608 JB 1H 472K-T	T
C1357	4030007000	S.CERAMIC C1608 CH 1H 090D-T	B
C1358	4030011600	S.CERAMIC C1608 JB 1E 104K-T	B
C1360	4030011600	S.CERAMIC C1608 JB 1E 104K-T	B
C1361	4030007020	S.CERAMIC C1608 CH 1H 120J-T	B
C1362	4030011600	S.CERAMIC C1608 JB 1E 104K-T	T
C1405	4030006900	S.CERAMIC C1608 JB 1H 103K-T	T
C1406	4030017810	S.CERAMIC C1608 CH 1H 102J-T	T
C1407	4030017810	S.CERAMIC C1608 CH 1H 102J-T	T
C1408	4030006900	S.CERAMIC C1608 JB 1H 103K-T	T
C1409	4030006900	S.CERAMIC C1608 JB 1H 103K-T	T
C1410	4030007030	S.CERAMIC C1608 CH 1H 150J-T	T
C1411	4030006990	S.CERAMIC C1608 CH 1H 080D-T	T
C1412	4030007030	S.CERAMIC C1608 CH 1H 150J-T	T
C1413	4030007020	S.CERAMIC C1608 CH 1H 120J-T	T
C1414	4030006990	S.CERAMIC C1608 CH 1H 080D-T	T
C1415	4030007020	S.CERAMIC C1608 CH 1H 120J-T	T
C1416	4030006900	S.CERAMIC C1608 JB 1H 103K-T	T
C1417	4030006900	S.CERAMIC C1608 JB 1H 103K-T	T
C1418	4030017810	S.CERAMIC C1608 CH 1H 102J-T	T
C1419	4030017810	S.CERAMIC C1608 CH 1H 102J-T	T
C1420	4030007120	S.CERAMIC C1608 CH 1H 820J-T	B
C1421	4030007150	S.CERAMIC C1608 CH 1H 151J-T	B
C1423	4030010750	S.CERAMIC C1608 CH 1H 201J-T	T
C1424	4030007010	S.CERAMIC C1608 CH 1H 100D-T	T
C1425	4030011600	S.CERAMIC C1608 JB 1E 104K-T	T
C1426	4030011600	S.CERAMIC C1608 JB 1E 104K-T	T
C1427	4030006900	S.CERAMIC C1608 JB 1H 103K-T	T
C1428	4030006980	S.CERAMIC C1608 CH 1H 070D-T	T
C1429	4030006900	S.CERAMIC C1608 JB 1H 103K-T	T
C1430	4030007040	S.CERAMIC C1608 CH 1H 180J-T	B
C1431	4030017810	S.CERAMIC C1608 CH 1H 102J-T	T
C1432	4030009980	S.CERAMIC C1608 JB 1H 152K-T	T
C1433	4030011600	S.CERAMIC C1608 JB 1E 104K-T	T
C1434	4030009920	S.CERAMIC C1608 CH 1H 050B-T	B
C1435	4030009920	S.CERAMIC C1608 CH 1H 050B-T	B
C1436	4030011600	S.CERAMIC C1608 JB 1E 104K-T	B
C1437	4030009920	S.CERAMIC C1608 CH 1H 050B-T	T
C1438	4030009920	S.CERAMIC C1608 CH 1H 050B-T	T
C1439	4030009920	S.CERAMIC C1608 CH 1H 050B-T	T
C1441	4030006880	S.CERAMIC C1608 JB 1H 472K-T	T
C1501	4030018530	S.CERAMIC C3216 CH 1H 103J-T	T
C1502	4550003220	S.TANTALUM TEESVA 1E 105M8L	T
C1503	4030006900	S.CERAMIC C1608 JB 1H 103K-T	T
C1504	4030012610	S.CERAMIC C2012 JB 1C 474K-T	T
C1505	4030007010	S.CERAMIC C1608 CH 1H 100D-T	T

[RXPLL-A UNIT]

REF NO.	ORDER NO.	DESCRIPTION	M.
C1506	4030010760	S.CERAMIC C1608 CH 1H 331J-T	T
C1507	4510004630	S.ELECTROLYTIC ECEV1CA100SR	T
C1508	4030011600	S.CERAMIC C1608 JB 1E 104K-T	B
C1509	4030018800	S.CERAMIC C3216 CH 1H 223J-T	T
C1510	4030007110	S.CERAMIC C1608 CH 1H 680J-T	T
C1511	4510004630	S.ELECTROLYTIC ECEV1CA100SR	T
C1512	4030011600	S.CERAMIC C1608 JB 1E 104K-T	T
C1513	4030011600	S.CERAMIC C1608 JB 1E 104K-T	T
C1514	4510004630	S.ELECTROLYTIC ECEV1CA100SR	T
C1515	4030007160	S.CERAMIC C1608 CH 1H 181J-T	T
C1516	4030009350	S.CERAMIC C1608 CH 1H 3R5B-T	T
C1517	4030007110	S.CERAMIC C1608 CH 1H 680J-T	T
C1518	4030018530	S.CERAMIC C3216 CH 1H 103J-T	T
C1519	4550003220	S.TANTALUM TEESVA 1E 105M8L	T
C1520	4030006900	S.CERAMIC C1608 JB 1H 103K-T	T
C1521	4030012610	S.CERAMIC C2012 JB 1C 474K-T	T
C1522	4030007010	S.CERAMIC C1608 CH 1H 100D-T	T
C1523	4030010760	S.CERAMIC C1608 CH 1H 331J-T	T
C1524	4030018800	S.CERAMIC C3216 CH 1H 223J-T	T
C1525	4510004630	S.ELECTROLYTIC ECEV1CA100SR	T
C1526	4030011600	S.CERAMIC C1608 JB 1E 104K-T	T
C1527	4030011600	S.CERAMIC C1608 JB 1E 104K-T	T
C1528	4510004630	S.ELECTROLYTIC ECEV1CA100SR	T
C1529	4030017870	S.CERAMIC C1608 CH 1H 681J-T	T
C1530	4030011330	S.CERAMIC C1608 CH 1H 391J-T	T
C1531	4510006220	S.ELECTROLYTIC ECEV1CA101UP	T
C1532	4030011600	S.CERAMIC C1608 JB 1E 104K-T	T
C1533	4030011600	S.CERAMIC C1608 JB 1E 104K-T	T
C1534	4510006220	S.ELECTROLYTIC ECEV1CA101UP	T
C1535	4030011600	S.CERAMIC C1608 JB 1E 104K-T	T
C1536	4030017870	S.CERAMIC C1608 CH 1H 681J-T	T
C1537	4510006220	S.ELECTROLYTIC ECEV1CA101UP	T
C1538	4030011600	S.CERAMIC C1608 JB 1E 104K-T	T
C1539	4030011600	S.CERAMIC C1608 JB 1E 104K-T	T
C1540	4510006220	S.ELECTROLYTIC ECEV1CA101UP	T
C1541	4030007050	S.CERAMIC C1608 CH 1H 220J-T	T
C1651	4030006880	S.CERAMIC C1608 JB 1H 472K-T	B
C1653	4030006880	S.CERAMIC C1608 JB 1H 472K-T	B
C1654	4030017810	S.CERAMIC C1608 CH 1H 102J-T	B
C1655	4030009530	S.CERAMIC C1608 CH 1H 030B-T	T
C1656	4610001970	S.TRIMMER TZC3P200A110R00	T
C1657	4030010220	S.CERAMIC C2012 CH 1H 102J-T	T
C1658	4030010220	S.CERAMIC C2012 CH 1H 102J-T	T
C1659	4030011600	S.CERAMIC C1608 JB 1E 104K-T	T
C1660	4030011600	S.CERAMIC C1608 JB 1E 104K-T	B
C1661	4030011600	S.CERAMIC C1608 JB 1E 104K-T	B
C1662	4030011600	S.CERAMIC C1608 JB 1E 104K-T	T
C1663	4030011600	S.CERAMIC C1608 JB 1E 104K-T	T
C1665	4030006900	S.CERAMIC C1608 JB 1H 103K-T	T
C1666	4030006880	S.CERAMIC C1608 CH 1H 472K-T	B
C1701	4030011600	S.CERAMIC C1608 JB 1E 104K-T	T
C1702	4030011600	S.CERAMIC C1608 JB 1E 104K-T	T
C1703	4510004600	ELECTROLYTIC 16 MV 1000 HC	T
C1704	4030011600	S.CERAMIC C1608 JB 1E 104K-T	B
C1705	4030011600	S.CERAMIC C1608 JB 1E 104K-T	B
C1706	4510004640	S.ELECTROLYTIC ECEV1CA470SP	T
C1707	4030011600	S.CERAMIC C1608 JB 1E 104K-T	T
C1708	4030006880	S.CERAMIC C1608 JB 1H 472K-T	T
C1709	4030006880	S.CERAMIC C1608 JB 1H 472K-T	T
C1710	4030006880	S.CERAMIC C1608 JB 1H 472K-T	T
C1711	4030011340	S.CERAMIC C1608 CH 1H 471J-T	T
C1712	4030011340	S.CERAMIC C1608 CH 1H 471J-T	T
C1713	4030006880	S.CERAMIC C1608 JB 1H 472K-T	B
C1714	4030006880	S.CERAMIC C1608 JB 1H 472K-T	B
C1716	4030006880	S.CERAMIC C1608 JB 1H 472K-T	B
C1717	4030006880	S.CERAMIC C1608 JB 1H 472K-T	B
C1719	4030006880	S.CERAMIC C1608 JB 1H 472K-T	B
C1720	4030006880	S.CERAMIC C1608 JB 1H 472K-T	B
C1721	4030006880	S.CERAMIC C1608 JB 1H 472K-T	B
RL1001	6330001750	RELAY FTR-B4CA012Z	T
RL1002	6330001750	RELAY FTR-B4CA012Z	T
RL1003	6330001750	RELAY FTR-B4CA012Z	T
RL1004	6330001750	RELAY FTR-B4CA012Z	T
RL1005	6330001750	RELAY FTR-B4CA012Z	T
RL1006	6330001750	RELAY FTR-B4CA012Z	T
RL1203	6330001750	RELAY FTR-B4CA012Z	T
RL1206	6330001750	RELAY FTR-B4CA012Z	T
J2	6510019990	S.CONNECTOR 52808-2291	T
J10	6510007020	CONNECTOR TMP-J01X-V6	T
J351	6510007020	CONNECTOR TMP-J01X-V6	T
J421	6510007020	CONNECTOR TMP-J01X-V6	T
J561	6510007020	CONNECTOR TMP-J01X-V6	T
J601	6510007020	CONNECTOR TMP-J01X-V6	T
J681	6510007020	CONNECTOR TMP-J01X-V6	T

M.=Mounted side (T: Mounted on the Top side, B: Mounted on the Bottom side)

S.=Surface mount

[RXPLL-A UNIT]

REF NO.	ORDER NO.	DESCRIPTION		M.
J831	6510007020	CONNECTOR	TMP-J01X-V6	T
J1001	6510007020	CONNECTOR	TMP-J01X-V6	T
J1002	6510007020	CONNECTOR	TMP-J01X-V6	T
J1101	6510007020	CONNECTOR	TMP-J01X-V6	T
J1201	6510007020	CONNECTOR	TMP-J01X-V6	T
J1301	6510007020	CONNECTOR	TMP-J01X-V6	T
J1501	6510018960	S.CONNECTOR	B2B-PH-SM3-TB	T
J1701	6510019980	S.CONNECTOR	52808-1691	T
W1052	9016201006	JUMPER	73/98/025/X98/X98	
W1401	9029495075	JUMPER	73/98/020/X98/X98	
W1411	7120000480	S.JUMPER	MJP-0.4-T	T
EP1	0910057614	PCB	B 5967D	
EP20	6910012350	S.BEAD	MMZ1608Y 102BT	T
EP21	6910012350	S.BEAD	MMZ1608Y 102BT	T
EP22	6910012350	S.BEAD	MMZ1608Y 102BT	T
EP101	6910012350	S.BEAD	MMZ1608Y 102BT	B
EP102	6910012350	S.BEAD	MMZ1608Y 102BT	B
EP103	6910012350	S.BEAD	MMZ1608Y 102BT	T
EP104	6910012350	S.BEAD	MMZ1608Y 102BT	T
EP105	6910012350	S.BEAD	MMZ1608Y 102BT	T
EP106	6910012350	S.BEAD	MMZ1608Y 102BT	T
EP107	6910012350	S.BEAD	MMZ1608Y 102BT	B
EP108	6910012350	S.BEAD	MMZ1608Y 102BT	B
EP1701	6910012350	S.BEAD	MMZ1608Y 102BT	T
EP1702	6910012350	S.BEAD	MMZ1608Y 102BT	T
EP1801	6910012350	S.BEAD	MMZ1608Y 102BT	B
EP1802	6910012350	S.BEAD	MMZ1608Y 102BT	B
EP1804	6910012350	S.BEAD	MMZ1608Y 102BT	B
EP1805	6910012350	S.BEAD	MMZ1608Y 102BT	B
EP1806	6910012350	S.BEAD	MMZ1608Y 102BT	B
EP1807	6910012350	S.BEAD	MMZ1608Y 102BT	B
EP1808	6910012350	S.BEAD	MMZ1608Y 102BT	B
EP1809	6910012350	S.BEAD	MMZ1608Y 102BT	B
EP1810	6910012350	S.BEAD	MMZ1608Y 102BT	B
EP1811	6910012350	S.BEAD	MMZ1608Y 102BT	B
EP1812	6910012350	S.BEAD	MMZ1608Y 102BT	B
EP1813	6910012350	S.BEAD	MMZ1608Y 102BT	B
EP1814	6910012350	S.BEAD	MMZ1608Y 102BT	B
EP1815	6910012350	S.BEAD	MMZ1608Y 102BT	B
EP1816	6910012350	S.BEAD	MMZ1608Y 102BT	B
EP1817	6910012350	S.BEAD	MMZ1608Y 102BT	B
EP1818	6910012350	S.BEAD	MMZ1608Y 102BT	B
EP1819	6910012350	S.BEAD	MMZ1608Y 102BT	B
EP1820	6910012350	S.BEAD	MMZ1608Y 102BT	B
EP1821	6910012350	S.BEAD	MMZ1608Y 102BT	B
EP1825	6910012350	S.BEAD	MMZ1608Y 102BT	B
EP1826	6910012350	S.BEAD	MMZ1608Y 102BT	B
EP1830	6910012350	S.BEAD	MMZ1608Y 102BT	B
EP1831	6910012350	S.BEAD	MMZ1608Y 102BT	B
EP1832	6910012350	S.BEAD	MMZ1608Y 102BT	B
EP1833	6910012350	S.BEAD	MMZ1608Y 102BT	B
EP1834	6910012350	S.BEAD	MMZ1608Y 102BT	B
EP1835	6910012350	S.BEAD	MMZ1608Y 102BT	B
EP1836	6910012350	S.BEAD	MMZ1608Y 102BT	T

[RXPLL-B UNIT]

REF NO.	ORDER NO.	DESCRIPTION		M.
IC1503	1110006100	S.IC	NJM5534MD-TE1	T
IC1504	1110006100	S.IC	NJM5534MD-TE1	T
IC1505	1110006190	S.IC	NJM074M-TE1	T
IC1506	1110006100	S.IC	NJM5534MD-TE1	T
IC1651	1130011920	S.IC	TC74LCX00F (EL)	T
IC1652	1110005420	S.IC	BA15532F-E2	T
IC1653	1110005100	S.IC	NJM072BM-TE2	B
IC1701	1130011530	S.IC	CD74HC4094M96	B
IC1702	1130011530	S.IC	CD74HC4094M96	T
IC1703	1160000130	S.IC	TD62783AF (S,EL)	T
IC1704	1180000790	S.IC	AN78L10M (E1)	B
Q1	1590001050	S.TRANSISTOR	DTC114TUA T106	B
Q30	1530002060	S.TRANSISTOR	2SC4081 T106 R	T
Q41	1590000680	S.TRANSISTOR	DTC114EUA T106	T
Q150	1560000330	S.FET	2SK210-GR (TE85R)	T
Q151	1530002280	S.TRANSISTOR	2SC4081 T106 S	B
Q152	1530002280	S.TRANSISTOR	2SC4081 T106 S	B
Q201	1590001330	S.TRANSISTOR	DTA114EUA T106	T
Q202	1560000530	S.FET	2SK880-GR (TE85R)	B
Q203	1530002490	S.TRANSISTOR	2SC3324-GR (TE85R)	T
Q204	1530002490	S.TRANSISTOR	2SC3324-GR (TE85R)	T
Q220	1560000330	S.FET	2SK210-GR (TE85R)	T
Q221	1530002060	S.TRANSISTOR	2SC4081 T106 R	T
Q230	1560000330	S.FET	2SK210-GR (TE85R)	T
Q240	1560000330	S.FET	2SK210-GR (TE85R)	T
Q250	1560000330	S.FET	2SK210-GR (TE85R)	T
Q260	1560000330	S.FET	2SK210-GR (TE85R)	T
Q270	1560000330	S.FET	2SK210-GR (TE85R)	T
Q280	1590000680	S.TRANSISTOR	DTC114EUA T106	T
Q281	1590000680	S.TRANSISTOR	DTC114EUA T106	T
Q282	1590000680	S.TRANSISTOR	DTC114EUA T106	T
Q283	1590000680	S.TRANSISTOR	DTC114EUA T106	T
Q284	1590000680	S.TRANSISTOR	DTC114EUA T106	T
Q285	1590000680	S.TRANSISTOR	DTC114EUA T106	T
Q301	1530003430	S.TRANSISTOR	2SC5226-4-TL	T
Q302	1530003430	S.TRANSISTOR	2SC5226-4-TL	B
Q341	1590000680	S.TRANSISTOR	DTC114EUA T106	T
Q351	1580000750	S.FET	3SK294 (TE85L)	T
Q352	1530003430	S.TRANSISTOR	2SC5226-4-TL	B
Q363	1590000680	S.TRANSISTOR	DTC114EUA T106	T
Q364	1590001330	S.TRANSISTOR	DTA114EUA T106	T
Q441	1590000680	S.TRANSISTOR	DTC114EUA T106	T
Q502	1590000680	S.TRANSISTOR	DTC114EUA T106	T
Q540	1530002060	S.TRANSISTOR	2SC4081 T106 R	B
Q541	1560000330	S.FET	2SK210-GR (TE85R)	T
Q561	1530003430	S.TRANSISTOR	2SC5226-4-TL	T
Q580	1530003430	S.TRANSISTOR	2SC5226-4-TL	T
Q591	1530003150	S.TRANSISTOR	2SC4673D-TD	T
Q592	1520000560	S.TRANSISTOR	2SB1123T-TD	B
Q593	1590000680	S.TRANSISTOR	DTC114EUA T106	B
Q601	1530002600	S.TRANSISTOR	2SC4215-O (TE85R)	T
Q680	1530002060	S.TRANSISTOR	2SC4081 T106 R	T
Q702	1530002600	S.TRANSISTOR	2SC4215-O (TE85R)	T
Q1001	1530003850	S.TRANSISTOR	2SC5551-F-TD	B
Q1004	1590001960	S.TRANSISTOR	XP4311 (TX)	T
Q1005	1590001960	S.TRANSISTOR	XP4311 (TX)	T
Q1006	1530003850	S.TRANSISTOR	2SC5551-F-TD	B
Q1007	1530003850	S.TRANSISTOR	2SC5551-F-TD	B
Q1008	1530003850	S.TRANSISTOR	2SC5551-F-TD	B
Q1101	1530003860	TRANSISTOR	2SC3950D	T
Q1102	1590000680	S.TRANSISTOR	DTC114EUA T106	T
Q1103	1520000560	S.TRANSISTOR	2SB1123T-TD	B
Q1104	1530003860	TRANSISTOR	2SC3950D	T
Q1105	1530003840	S.TRANSISTOR	2SC5501-4-TR	T
Q1205	1590001960	S.TRANSISTOR	XP4311 (TX)	T
Q1209	1530003850	S.TRANSISTOR	2SC5551-F-TD	B
Q1210	1530003850	S.TRANSISTOR	2SC5551-F-TD	B
Q1211	1560001310	S.FET	MMBFU310LT1	T
Q1212	1560001310	S.FET	MMBFU310LT1	T
Q1213	1590000680	S.TRANSISTOR	DTC114EUA T106	B
Q1214	1520000560	S.TRANSISTOR	2SB1123T-TD	B
Q1301	1530003150	S.TRANSISTOR	2SC4673D-TD	T
Q1352	1530003850	S.TRANSISTOR	2SC5551-F-TD	T
Q1401	1530003840	S.TRANSISTOR	2SC5501-4-TR	B
Q1402	1530003020	S.TRANSISTOR	2SC4402-3-TL	T
Q1403	1530003020	S.TRANSISTOR	2SC4402-3-TL	T
Q1501	1530003450	S.TRANSISTOR	2SC4835-R (TX)	T
Q1502	1530003450	S.TRANSISTOR	2SC4835-R (TX)	T
Q1651	1530002600	S.TRANSISTOR	2SC4215-O (TE85R)	B
Q1701	1590001960	S.TRANSISTOR	XP4311 (TX)	T
Q1702	1590001960	S.TRANSISTOR	XP4311 (TX)	T
Q1703	1590001960	S.TRANSISTOR	XP4311 (TX)	T
D101	1750000520	S.DIODE	DAN222TL	T
D152	1720000590	S.VARICAP	MA357 (TX)	T

[RXPLL-B UNIT]

REF NO.	ORDER NO.	DESCRIPTION		M.
IC1	1130011530	S.IC	CD74HC4094M96	T
IC2	1130009690	S.IC	TC74HCT7007AF	T
IC51	1180001250	S.IC	TA7808F (TE16L)	T
IC61	1180000420	S.IC	TA78L05F (TE12R)	B
IC101	1140007880	S.IC	TC190G08AF-0046-Z/SC-1246A	T
IC102	1130003830	S.IC	TC7S04F (TE85R)	T
IC104	1130003830	S.IC	TC7S04F (TE85R)	T
IC201	1130009230	S.IC	LMX2306TMX	T
IC501	1140007880	S.IC	TC190G08AF-0046-Z/SC-1246A	T
IC502	1130003830	S.IC	TC7S04F (TE85R)	T
IC503	1130003830	S.IC	TC7S04F (TE85R)	T
IC651	1140004550	S.IC	M65343FP/SC1287	T
IC652	1130003830	S.IC	TC7S04F (TE85R)	T
IC1051	1190002010	S.IC	SD5400CY <I>	T
IC1081	1110006180	S.IC	UPG2009TB-E3	B
IC1402	1110006180	S.IC	UPG2009TB-E3	T
IC1403	1110006180	S.IC	UPG2009TB-E3	T
IC1501	1110006120	S.IC	DBM9A41-TR	T
IC1502	1110006120	S.IC	DBM9A41-TR	T

M.-Mounted side (T: Mounted on the Top side, B: Mounted on the Bottom side)

S.-Surface mount

[RXPLL-B UNIT]

REF NO.	ORDER NO.	DESCRIPTION	M.
D153	1790000490	S.DIODE HSM88AS-TR	T
D154	1790000490	S.DIODE HSM88AS-TR	T
D201	1750000520	S.DIODE DAN222TL	T
D220	1720000590	S.VARICAP MA357 (TX)	T
D221	1720000590	S.VARICAP MA357 (TX)	T
D222	1790000620	S.DIODE MA77 (TX)	T
D230	1720000590	S.VARICAP MA357 (TX)	T
D231	1720000590	S.VARICAP MA357 (TX)	T
D232	1790000620	S.DIODE MA77 (TX)	T
D240	1720000590	S.VARICAP MA357 (TX)	T
D241	1720000590	S.VARICAP MA357 (TX)	T
D242	1790000620	S.DIODE MA77 (TX)	T
D250	1720000590	S.VARICAP MA357 (TX)	T
D251	1720000590	S.VARICAP MA357 (TX)	T
D252	1790000620	S.DIODE MA77 (TX)	T
D261	1720000590	S.VARICAP MA357 (TX)	T
D262	1790000620	S.DIODE MA77 (TX)	T
D271	1720000590	S.VARICAP MA357 (TX)	T
D272	1790000620	S.DIODE MA77 (TX)	T
D341	1790000620	S.DIODE MA77 (TX)	T
D342	1750000520	S.DIODE DAN222TL	B
D362	1790000620	S.DIODE MA77 (TX)	T
D363	1790000620	S.DIODE MA77 (TX)	T
D421	1790000620	S.DIODE MA77 (TX)	T
D441	1790000620	S.DIODE MA77 (TX)	T
D501	1750000520	S.DIODE DAN222TL	T
D541	1720000590	S.VARICAP MA357 (TX)	T
D542	1720000590	S.VARICAP MA357 (TX)	T
D1101	1790000620	S.DIODE MA77 (TX)	T
D1102	1790000620	S.DIODE MA77 (TX)	T
D1351	1750000580	S.DIODE 1SV307 (TPH3)	T
D1653	1750000550	S.DIODE 1S3355 TE-17	T
D1654	1750000550	S.DIODE 1S3355 TE-17	T
D1701	1790001670	S.DIODE RB706F-40T106	T
FI101	2020002090	S.CERAMIC SFECV10M7FD00-R0	T
FI1401	2030000320	S.MONOLITH FL-359 (64.555 MHz)	T
FI1402	2030000310	S.MONOLITH FL-360 (64.555 MHz)	T
L1	6200003260	S.COIL NL 322522T-101J	T
L2	6200003260	S.COIL NL 322522T-101J	T
L10	6200003950	S.COIL HF50ACC 322513-T	T
L11	6200003950	S.COIL HF50ACC 322513-T	T
L12	6200003950	S.COIL HF50ACC 322513-T	T
L13	6200003950	S.COIL HF50ACC 322513-T	T
L20	6200003320	S.COIL NL 322522T-3R3J-3	T
L30	6200005490	S.COIL NL 322522T-331J	T
L101	6200001830	S.COIL NL 322522T-100J	T
L151	6130002970	COIL LB-343	T
L152	6200001830	S.COIL NL 322522T-100J	T
L201	6200005010	S.COIL NL 252018T-100J	T
L220	6200010790	S.COIL C2520C-3R9G-A	T
L221	6190001420	COIL E526GN-110502	T
L222	6200010790	S.COIL C2520C-3R9G-A	T
L230	6200010830	S.COIL C2520C-3R3G-A	T
L231	6190001420	COIL E526GN-110502	T
L232	6200010830	S.COIL C2520C-3R3G-A	T
L240	6200010830	S.COIL C2520C-3R3G-A	T
L241	6190001420	COIL E526GN-110502	T
L242	6200010830	S.COIL C2520C-3R3G-A	T
L250	6200010820	S.COIL C2520C-2R7G-A	T
L251	6190001420	COIL E526GN-110502	T
L252	6200010820	S.COIL C2520C-2R7G-A	T
L260	6200010820	S.COIL C2520C-2R7G-A	T
L261	6190001410	COIL E526GN-110501	T
L262	6200010820	S.COIL C2520C-2R7G-A	T
L270	6200010810	S.COIL C2520C-2R2G-A	T
L271	6190001410	COIL E526GN-110501	T
L272	6200010810	S.COIL C2520C-2R2G-A	T
L280	6200005010	S.COIL NL 252018T-100J	T
L302	6200001830	S.COIL NL 322522T-100J	T
L331	6200002640	S.COIL NL 252018T-R15J	T
L332	6200002410	S.COIL NL 252018T-056J	B
L341	6200003260	S.COIL NL 322522T-101J	T
L351	6200001830	S.COIL NL 322522T-100J	T
L421	6200008640	S.COIL NL 322522T-391J	T
L441	6200002600	S.COIL NL 252018T-047J	T
L442	6200010730	S.COIL C2520C-68NG-A	T
L451	6200002640	S.COIL NL 252018T-R15J	T
L452	6200003260	S.COIL NL 322522T-101J	T
L501	6200001830	S.COIL NL 322522T-100J	T
L530	6200003170	S.COIL NL 322522T-330J	T
L531	6200003170	S.COIL NL 322522T-330J	T
L532	6200003170	S.COIL NL 322522T-330J	T
L541	6200010790	S.COIL C2520C-3R9G-A	T
L542	6190001420	COIL E526GN-110502	T

[RXPLL-B UNIT]

REF NO.	ORDER NO.	DESCRIPTION	M.
L543	6200010790	S.COIL C2520C-3R9G-A	T
L544	6200003260	S.COIL NL 322522T-101J	B
L545	6200003260	S.COIL NL 322522T-101J	B
L561	6200003260	S.COIL NL 322522T-101J	B
L562	6200001830	S.COIL NL 322522T-100J	T
L565	6150004250	COIL LS-471A (C-14922)	T
L566	6150004250	COIL LS-471A (C-14922)	T
L591	6200007790	S.COIL LQW2BHNRI5J01L (LQN21A R15J04)	T
L601	6200001830	S.COIL NL 322522T-100J	T
L602	6200002640	S.COIL NL 252018T-R15J	T
L603	6200002840	S.COIL NL 252018T-R22J	T
L651	6200001830	S.COIL NL 322522T-100J	T
L681	6200002980	S.COIL NL 322522T-R56J-3	T
L682	6200003040	S.COIL NL 322522T-R68J-3	T
L683	6200003050	S.COIL NL 322522T-R82J-3	T
L701	6200003260	S.COIL NL 322522T-101J	T
L702	6150004970	S.COIL LS-522	T
L703	6150004970	S.COIL LS-522	T
L1001	6190001650	COIL ELC06D102E	T
L1002	6140004400	COIL LR-499	T
L1004	6140003890	COIL LR-488	T
L1005	6180001000	COIL LAL 04NA 102K	T
L1006	6140003900	COIL LR-489	T
L1007	6140003800	COIL LR-439	T
L1008	6190001650	COIL ELC06D102E	T
L1009	6190001650	COIL ELC06D102E	T
L1010	6140003880	S.COIL LR-486	T
L1011	6140003880	S.COIL LR-486	T
L1012	6140003800	COIL LR-439	T
L1013	6200010680	S.COIL C2520C-R22G (0.22U)	T
L1014	6200010680	S.COIL C2520C-R22G (0.22U)	T
L1015	6200007790	S.COIL LQW2BHNRI5J01L (LQN21A R15J04)	B
L1052	6200010740	S.COIL C2520C-R27G-A	T
L1053	6200010740	S.COIL C2520C-R27G-A	T
L1054	6200010740	S.COIL C2520C-R27G-A	T
L1055	6140003960	COIL LR-495	T
L1056	6200010730	S.COIL C2520C-68NG-A	T
L1058	6190001630	COIL E544EN-100021	T
L1059	6200010650	S.COIL C2520C-R12G (0.12U)	T
L1060	6200010870	S.COIL C2520C-R33G (0.33U)	T
L1062	6200010660	S.COIL C2520C-R15G (0.15U)	T
L1071	6200007780	S.COIL LQW2BHNRI2J01L (LQN21A R12J04)	B
L1072	6200007780	S.COIL LQW2BHNRI2J01L (LQN21A R12J04)	B
L1091	6200003950	S.COIL HF50ACC 322513-T	T
L1092	6200003950	S.COIL HF50ACC 322513-T	T
L1093	6200003950	S.COIL HF50ACC 322513-T	T
L1101	6140003920	COIL LR-491	T
L1102	6200010670	S.COIL C2520C-R18G (0.18U)	T
L1103	6180001250	COIL LAL 04NA 3R3K	T
L1104	6200010680	S.COIL C2520C-R22G (0.22U)	T
L1105	6140003910	COIL LR-490	T
L1208	6140003800	COIL LR-439	T
L1209	6200001830	S.COIL NL 322522T-100J	T
L1210	6140003870	COIL LR-487	T
L1211	6200009690	S.COIL LQH43CN101K01L (LQH 4C 101K04)	T
L1212	6200001830	S.COIL NL 322522T-100J	T
L1213	6140003870	COIL LR-487	T
L1214	6200009690	S.COIL LQH43CN101K01L (LQH 4C 101K04)	T
L1216	6140003800	COIL LR-439	T
L1217	6200007750	S.COIL LQW2BHN56NJ01L (LQN21A 56NJ04)	T
L1218	6200007770	S.COIL LQW2BHNRI0J01L (LQN21A R10J04)	T
L1219	6200007790	S.COIL LQW2BHNRI5J01L (LQN21A R15J04)	T
L1220	6140000930	COIL LR-116	T
L1221	6200003260	S.COIL NL 322522T-101J	B
L1222	6150001770	COIL LS-198	T
L1228	6200010870	S.COIL C2520C-R33G (0.33U)	T
L1229	6200003950	S.COIL HF50ACC 322513-T	B
L1301	6200008090	S.COIL LQW2BHN68NJ01L (LQN21A 68NJ04)	T
L1302	6200008090	S.COIL LQW2BHN68NJ01L (LQN21A 68NJ04)	T
L1303	6200008090	S.COIL LQW2BHN68NJ01L (LQN21A 68NJ04)	T
L1304	6200010870	S.COIL C2520C-R33G (0.33U)	T
L1305	6200003000	S.COIL NL 322522T-R22J-3	T
L1306	6200001830	S.COIL NL 322522T-100J	B
L1307	6200003000	S.COIL NL 322522T-R22J-3	T
L1351	6200001830	S.COIL NL 322522T-100J	T
L1353	6200010740	S.COIL C2520C-R27G-A	T
L1354	6200001830	S.COIL NL 322522T-100J	T
L1401	6150004280	COIL LS-484B (C-14927)	T
L1402	6150004280	COIL LS-484B (C-14927)	T
L1403	6150004280	COIL LS-484B (C-14927)	T
L1404	6150004280	COIL LS-484B (C-14927)	T
L1405	6200007770	S.COIL LQW2BHNRI0J01L (LQN21A R10J04)	B
L1406	6200007750	S.COIL LQW2BHN56NJ01L (LQN21A 56NJ04)	B
L1407	6140003930	COIL LR-492	T
L1408	6190001620	COIL E544EN-100028	T
L1409	6200003190	S.COIL NL 322522T-470J	B
L1501	6200003520	S.COIL ELJFB 102K-F	T
L1652	6200002520	S.COIL ELJNC R18K-F	T

M.=Mounted side (T: Mounted on the Top side, B: Mounted on the Bottom side)

S.=Surface mount

[RXPLL-B UNIT]

REF NO.	ORDER NO.	DESCRIPTION	M.
L1653	6200001830	S.COIL NL 322522T-100J	B
L1654	6200001830	S.COIL NL 322522T-100J	B
L1655	6200001830	S.COIL NL 322522T-100J	B
L1701	6200001830	S.COIL NL 322522T-100J	T
L1702	6200003950	S.COIL HF50ACC 322513-T	T
L1703	6200003950	S.COIL HF50ACC 322513-T	T
L1704	6200003950	S.COIL HF50ACC 322513-T	T
L1705	6200003950	S.COIL HF50ACC 322513-T	T
L1803	6200003950	S.COIL HF50ACC 322513-T	B
L1804	6200003950	S.COIL HF50ACC 322513-T	B
L1805	6200003950	S.COIL HF50ACC 322513-T	B
L1807	6200003950	S.COIL HF50ACC 322513-T	B
L1808	6200003950	S.COIL HF50ACC 322513-T	B
L1809	6200003950	S.COIL HF50ACC 322513-T	B
R1	7030005871	S.RESISTOR ERA3YKD 104V (100 kΩ)	T
R2	7030005321	S.RESISTOR ERA3YED 103V	T
R3	7030003550	S.RESISTOR ERJ3GEYJ 822 V (8.2 kΩ)	T
R4	7030003550	S.RESISTOR ERJ3GEYJ 822 V (8.2 kΩ)	T
R5	7030003550	S.RESISTOR ERJ3GEYJ 822 V (8.2 kΩ)	T
R6	7030003550	S.RESISTOR ERJ3GEYJ 822 V (8.2 kΩ)	T
R10	7030003360	S.RESISTOR ERJ3GEYJ 221 V (220 Ω)	T
R11	7030003360	S.RESISTOR ERJ3GEYJ 221 V (220 Ω)	T
R12	7030003360	S.RESISTOR ERJ3GEYJ 221 V (220 Ω)	T
R13	7030003360	S.RESISTOR ERJ3GEYJ 221 V (220 Ω)	T
R14	7030003360	S.RESISTOR ERJ3GEYJ 221 V (220 Ω)	T
R15	7030003360	S.RESISTOR ERJ3GEYJ 221 V (220 Ω)	T
R16	7030003360	S.RESISTOR ERJ3GEYJ 221 V (220 Ω)	T
R17	7030003360	S.RESISTOR ERJ3GEYJ 221 V (220 Ω)	T
R30	7030003240	S.RESISTOR ERJ3GEYJ 220 V (22 Ω)	T
R31	7030003600	S.RESISTOR ERJ3GEYJ 223 V (22 kΩ)	T
R32	7030003320	S.RESISTOR ERJ3GEYJ 101 V (100 Ω)	T
R33	7030003340	S.RESISTOR ERJ3GEYJ 151 V (150 Ω)	T
R51	7030011030	S.RESISTOR ERJ1TYJ 270U (27 Ω)	T
R61	7030011030	S.RESISTOR ERJ1TYJ 270U (27 Ω)	T
R101	7030003800	S.RESISTOR ERJ3GEYJ 105 V (1 MΩ)	T
R102	7030003860	S.RESISTOR ERJ3GE JPW V	B
R103	7030007230	S.RESISTOR ERA3YED 102V	T
R104	7030007230	S.RESISTOR ERA3YED 102V	T
R105	7030007230	S.RESISTOR ERA3YED 102V	T
R106	7030003360	S.RESISTOR ERJ3GEYJ 221 V (220 Ω)	T
R107	7030003320	S.RESISTOR ERJ3GEYJ 101 V (100 Ω)	T
R108	7030007230	S.RESISTOR ERA3YED 102V	T
R109	7030007230	S.RESISTOR ERA3YED 102V	T
R110	7030007220	S.RESISTOR ERA3YED 202V	T
R111	7030007220	S.RESISTOR ERA3YED 202V	T
R112	7030007220	S.RESISTOR ERA3YED 202V	T
R113	7030007220	S.RESISTOR ERA3YED 202V	T
R114	7030007220	S.RESISTOR ERA3YED 202V	T
R115	7030007220	S.RESISTOR ERA3YED 202V	T
R116	7030007220	S.RESISTOR ERA3YED 202V	T
R117	7030007220	S.RESISTOR ERA3YED 202V	T
R118	7030007200	S.RESISTOR ERA3YEB 202V	T
R119	7030007200	S.RESISTOR ERA3YEB 202V	T
R120	7030007200	S.RESISTOR ERA3YEB 202V	T
R121	7030007200	S.RESISTOR ERA3YEB 202V	T
R122	7030007200	S.RESISTOR ERA3YEB 202V	T
R123	7030007230	S.RESISTOR ERA3YED 102V	T
R124	7030007230	S.RESISTOR ERA3YED 102V	T
R125	7030007230	S.RESISTOR ERA3YED 102V	T
R126	7030007230	S.RESISTOR ERA3YED 102V	T
R127	7030007230	S.RESISTOR ERA3YED 102V	T
R128	7030007230	S.RESISTOR ERA3YED 102V	T
R129	7030007210	S.RESISTOR ERA3YEB 102V	T
R130	7030007210	S.RESISTOR ERA3YEB 102V	T
R131	7030007210	S.RESISTOR ERA3YEB 102V	T
R132	7030007210	S.RESISTOR ERA3YEB 102V	T
R133	7030007210	S.RESISTOR ERA3YEB 102V	T
R134	7030009861	S.RESISTOR ERA3YED 471V	T
R135	7030003860	S.RESISTOR ERJ3GE JPW V	T
R136	7030003800	S.RESISTOR ERJ3GEYJ 105 V (1 MΩ)	T
R137	7030003200	S.RESISTOR ERJ3GEYJ 100 V (10 Ω)	T
R138	7030003860	S.RESISTOR ERJ3GE JPW V	T
R139	7030003860	S.RESISTOR ERJ3GE JPW V	T
R150	7030003330	S.RESISTOR ERJ3GEYJ 121 V (120 Ω)	B
R151	7030003220	S.RESISTOR ERJ3GEYJ 150 V (15 Ω)	B
R152	7030005321	S.RESISTOR ERA3YED 103V	B
R153	7030005321	S.RESISTOR ERA3YED 103V	B
R154	7030003320	S.RESISTOR ERJ3GEYJ 101 V (100 Ω)	B
R155	7030003350	S.RESISTOR ERJ3GEYJ 181 V (180 Ω)	B
R156	7030005871	S.RESISTOR ERA3YKD 104V (100 kΩ)	T
R157	7030005871	S.RESISTOR ERA3YKD 104V (100 kΩ)	T
R158	7030003340	S.RESISTOR ERJ3GEYJ 151 V (150 Ω)	T
R159	7030003320	S.RESISTOR ERJ3GEYJ 101 V (100 Ω)	B
R160	7030003360	S.RESISTOR ERJ3GEYJ 221 V (220 Ω)	B
R161	7030003640	S.RESISTOR ERJ3GEYJ 473 V (47 kΩ)	B
R163	7030003220	S.RESISTOR ERJ3GEYJ 150 V (15 Ω)	B

[RXPLL-B UNIT]

REF NO.	ORDER NO.	DESCRIPTION	M.
R164	7030003310	S.RESISTOR ERJ3GEYJ 820 V (82 Ω)	B
R165	7030003320	S.RESISTOR ERJ3GEYJ 101 V (100 Ω)	B
R166	7030003320	S.RESISTOR ERJ3GEYJ 101 V (100 Ω)	B
R167	7030003240	S.RESISTOR ERJ3GEYJ 220 V (22 Ω)	B
R168	7030003360	S.RESISTOR ERJ3GEYJ 221 V (220 Ω)	B
R169	7030003640	S.RESISTOR ERJ3GEYJ 473 V (47 kΩ)	B
R202	7030007230	S.RESISTOR ERA3YED 102V	T
R203	7030007230	S.RESISTOR ERA3YED 102V	T
R204	7030003360	S.RESISTOR ERJ3GEYJ 221 V (220 Ω)	T
R205	7030005321	S.RESISTOR ERA3YED 103V	T
R206	7030003220	S.RESISTOR ERJ3GEYJ 150 V (15 Ω)	T
R210	7030007230	S.RESISTOR ERA3YED 102V	T
R211	7030009591	S.RESISTOR ERA3YED 472V	T
R212	7030007230	S.RESISTOR ERA3YED 102V	T
R213	7030007230	S.RESISTOR ERA3YED 102V	T
R214	7030007230	S.RESISTOR ERA3YED 102V	T
R215	7030009861	S.RESISTOR ERA3YED 471V	T
R216	7030009861	S.RESISTOR ERA3YED 471V	T
R219	7030003860	S.RESISTOR ERJ3GE JPW V	T
R220	7030005871	S.RESISTOR ERA3YKD 104V (100 kΩ)	T
R221	7030005871	S.RESISTOR ERA3YKD 104V (100 kΩ)	T
R222	7030003360	S.RESISTOR ERJ3GEYJ 221 V (220 Ω)	T
R223	7030007230	S.RESISTOR ERA3YED 102V	T
R224	7030003320	S.RESISTOR ERJ3GEYJ 101 V (100 Ω)	T
R230	7030005871	S.RESISTOR ERA3YKD 104V (100 kΩ)	T
R231	7030005871	S.RESISTOR ERA3YKD 104V (100 kΩ)	T
R232	7030003360	S.RESISTOR ERJ3GEYJ 221 V (220 Ω)	T
R233	7030007230	S.RESISTOR ERA3YED 102V	T
R234	7030003320	S.RESISTOR ERJ3GEYJ 101 V (100 Ω)	T
R240	7030005871	S.RESISTOR ERA3YKD 104V (100 kΩ)	T
R241	7030005871	S.RESISTOR ERA3YKD 104V (100 kΩ)	T
R242	7030003360	S.RESISTOR ERJ3GEYJ 221 V (220 Ω)	T
R243	7030007230	S.RESISTOR ERA3YED 102V	T
R244	7030003320	S.RESISTOR ERJ3GEYJ 101 V (100 Ω)	T
R250	7030005871	S.RESISTOR ERA3YKD 104V (100 kΩ)	T
R251	7030005871	S.RESISTOR ERA3YKD 104V (100 kΩ)	T
R252	7030003360	S.RESISTOR ERJ3GEYJ 221 V (220 Ω)	T
R253	7030007230	S.RESISTOR ERA3YED 102V	T
R254	7030003320	S.RESISTOR ERJ3GEYJ 101 V (100 Ω)	T
R260	7030005871	S.RESISTOR ERA3YKD 104V (100 kΩ)	T
R261	7030005871	S.RESISTOR ERA3YKD 104V (100 kΩ)	T
R262	7030003360	S.RESISTOR ERJ3GEYJ 221 V (220 Ω)	T
R263	7030007230	S.RESISTOR ERA3YED 102V	T
R264	7030003320	S.RESISTOR ERJ3GEYJ 101 V (100 Ω)	T
R270	7030005871	S.RESISTOR ERA3YKD 104V (100 kΩ)	T
R271	7030005871	S.RESISTOR ERA3YKD 104V (100 kΩ)	T
R272	7030003360	S.RESISTOR ERJ3GEYJ 221 V (220 Ω)	T
R273	7030007230	S.RESISTOR ERA3YED 102V	T
R274	7030003320	S.RESISTOR ERJ3GEYJ 101 V (100 Ω)	T
R301	7030003200	S.RESISTOR ERJ3GEYJ 100 V (10 Ω)	T
R302	7030007230	S.RESISTOR ERA3YED 102V	T
R303	7030003360	S.RESISTOR ERJ3GEYJ 221 V (220 Ω)	T
R304	7030003490	S.RESISTOR ERA3YED 272 V (2.7 kΩ)	T
R305	7030003510	S.RESISTOR ERJ3GEYJ 392 V (3.9 kΩ)	T
R306	7030003360	S.RESISTOR ERJ3GEYJ 221 V (220 Ω)	T
R307	7030009841	S.RESISTOR ERA3YHD 330V	T
R308	7030009851	S.RESISTOR ERA3YED 271V	B
R309	7030003540	S.RESISTOR ERJ3GEYJ 682 V (6.8 kΩ)	B
R310	7030003500	S.RESISTOR ERJ3GEYJ 332 V (3.3 kΩ)	B
R311	7030003350	S.RESISTOR ERJ3GEYJ 181 V (180 Ω)	B
R317	7030006270	S.RESISTOR ERJ12YJ221U (220 Ω)	B
R318	7030009841	S.RESISTOR ERA3YHD 330V	B
R341	7030007230	S.RESISTOR ERA3YED 102V	T
R342	7030005321	S.RESISTOR ERA3YED 103V	T
R343	7030007230	S.RESISTOR ERA3YED 102V	T
R351	7030003200	S.RESISTOR ERJ3GEYJ 100 V (10 Ω)	B
R352	7030010980	S.RESISTOR ERA3YHD 470V	T
R353	7030009591	S.RESISTOR ERA3YED 472V	T
R354	7030009591	S.RESISTOR ERA3YED 472V	T
R355	7030009591	S.RESISTOR ERA3YED 472V	T
R356	7030003320	S.RESISTOR ERJ3GEYJ 101 V (100 Ω)	T
R357	7310002720	S.TRIMMER RV-148 (RH03A3AS3X0DA) 472	T
R358	7030010980	S.RESISTOR ERA3YHD 470V	T
R359	7030003320	S.RESISTOR ERJ3GEYJ 101 V (100 Ω)	T
R360	7030003320	S.RESISTOR ERJ3GEYJ 101 V (100 Ω)	B
R361	7030003490	S.RESISTOR ERJ3GEYJ 272 V (2.7 kΩ)	B
R362	7030003510	S.RESISTOR ERJ3GEYJ 392 V (3.9 kΩ)	B
R363	7030003320	S.RESISTOR ERJ3GEYJ 101 V (100 Ω)	B
R364	7030003410	S.RESISTOR ERJ3GEYJ 561 V (560 Ω)	T
R365	7030007860	S.RESISTOR ERJ3GEYJ 8R2V (8.2 Ω)	T
R366	7030003410	S.RESISTOR ERJ3GEYJ 561 V (560 Ω)	T
R368	7030005321	S.RESISTOR ERA3YED 103V	T
R369	7030008240	S.RESISTOR ERJ12YJ0R00U	B
R421	7030007230	S.RESISTOR ERA3YED 102V	T
R425	7030003410	S.RESISTOR ERJ3GEYJ 561 V (560 Ω)	T
R427	7030003320	S.RESISTOR ERJ3GEYJ 101 V (100 Ω)	B
R428	7030009861	S.RESISTOR ERA3YED 471V	B
R441	7030007230	S.RESISTOR ERA3YED 102V	T

M.—Mounted side (T: Mounted on the Top side, B: Mounted on the Bottom side)

S.—Surface mount

[RXPLL-B UNIT]

REF NO.	ORDER NO.	DESCRIPTION	M.
R442	7030005321	S.RESISTOR ERA3YED 103V	T
R443	7030007230	S.RESISTOR ERA3YED 102V	T
R501	7030003360	S.RESISTOR ERJ3GEYJ 221 V (220 Ω)	T
R502	7030007230	S.RESISTOR ERA3YED 102V	T
R503	7030007230	S.RESISTOR ERA3YED 102V	T
R504	7030007230	S.RESISTOR ERA3YED 102V	T
R506	7030003800	S.RESISTOR ERJ3GEYJ 105 V (1 MΩ)	T
R509	7030007230	S.RESISTOR ERA3YED 102V	T
R510	7030007220	S.RESISTOR ERA3YED 202V	T
R511	7030007220	S.RESISTOR ERA3YED 202V	T
R512	7030007220	S.RESISTOR ERA3YED 202V	T
R513	7030007220	S.RESISTOR ERA3YED 202V	T
R514	7030007220	S.RESISTOR ERA3YED 202V	T
R515	7030007220	S.RESISTOR ERA3YED 202V	T
R516	7030007220	S.RESISTOR ERA3YED 202V	T
R517	7030007220	S.RESISTOR ERA3YED 202V	T
R518	7030007200	S.RESISTOR ERA3YEB 202V	T
R519	7030007200	S.RESISTOR ERA3YEB 202V	T
R520	7030007200	S.RESISTOR ERA3YEB 202V	T
R521	7030007200	S.RESISTOR ERA3YEB 202V	T
R522	7030007200	S.RESISTOR ERA3YEB 202V	T
R523	7030007230	S.RESISTOR ERA3YED 102V	T
R524	7030007230	S.RESISTOR ERA3YED 102V	T
R525	7030007230	S.RESISTOR ERA3YED 102V	T
R526	7030007230	S.RESISTOR ERA3YED 102V	T
R527	7030007230	S.RESISTOR ERA3YED 102V	T
R528	7030007230	S.RESISTOR ERA3YED 102V	T
R529	7030007210	S.RESISTOR ERA3YEB 102V	T
R530	7030007210	S.RESISTOR ERA3YEB 102V	T
R531	7030007210	S.RESISTOR ERA3YEB 102V	T
R532	7030007210	S.RESISTOR ERA3YEB 102V	T
R533	7030007210	S.RESISTOR ERA3YEB 102V	T
R534	7030003860	S.RESISTOR ERJ3GE JPW V	T
R535	7030003800	S.RESISTOR ERJ3GEYJ 105 V (1 MΩ)	T
R536	7030003200	S.RESISTOR ERJ3GEYJ 100 V (10 Ω)	T
R537	7030007230	S.RESISTOR ERA3YED 102V	T
R538	7030003360	S.RESISTOR ERJ3GEYJ 221 V (220 Ω)	B
R540	7030007230	S.RESISTOR ERA3YED 102V	T
R544	7030005871	S.RESISTOR ERA3YKD 104V (100 kΩ)	T
R545	7030005871	S.RESISTOR ERA3YKD 104V (100 kΩ)	T
R546	7030009861	S.RESISTOR ERA3YED 471V	T
R548	7030009591	S.RESISTOR ERA3YED 472V	T
R550	7030009691	S.RESISTOR ERA3YED 101V (100 Ω)	B
R554	7030009691	S.RESISTOR ERA3YED 101V (100 Ω)	B
R555	7030003380	S.RESISTOR ERJ3GEYJ 331 V (330 Ω)	B
R556	7030003800	S.RESISTOR ERJ3GEYJ 105 V (1 MΩ)	B
R561	7030003200	S.RESISTOR ERJ3GEYJ 100 V (10 Ω)	T
R562	7030003360	S.RESISTOR ERJ3GEYJ 221 V (220 Ω)	T
R563	7030003490	S.RESISTOR ERJ3GEYJ 272 V (2.7 kΩ)	T
R564	7030003510	S.RESISTOR ERJ3GEYJ 392 V (3.9 kΩ)	T
R565	7030003360	S.RESISTOR ERJ3GEYJ 221 V (220 Ω)	T
R570	7030003230	S.RESISTOR ERJ3GEYJ 180 V (18 Ω)	T
R571	7030003230	S.RESISTOR ERJ3GEYJ 180 V (18 Ω)	T
R572	7030003290	S.RESISTOR ERJ3GEYJ 560 V (56 Ω)	B
R573	7030003270	S.RESISTOR ERJ3GEYJ 390 V (39 Ω)	T
R574	7030003240	S.RESISTOR ERJ3GEYJ 220 V (22 Ω)	T
R575	7030003270	S.RESISTOR ERJ3GEYJ 390 V (39 Ω)	T
R580	7030009861	S.RESISTOR ERA3YED 471V	T
R581	7030003360	S.RESISTOR ERJ3GEYJ 221 V (220 Ω)	T
R582	7030003600	S.RESISTOR ERJ3GEYJ 223 V (22 kΩ)	T
R587	7030003300	S.RESISTOR ERJ3GEYJ 680 V (68 Ω)	T
R588	7030003340	S.RESISTOR ERJ3GEYJ 151 V (150 Ω)	T
R589	7030003300	S.RESISTOR ERJ3GEYJ 680 V (68 Ω)	T
R591	7030003320	S.RESISTOR ERJ3GEYJ 101 V (100 Ω)	T
R592	7030005321	S.RESISTOR ERA3YED 103V	T
R593	7030003480	S.RESISTOR ERJ3GEYJ 222 V (2.2 kΩ)	T
R594	7030003320	S.RESISTOR ERJ3GEYJ 101 V (100 Ω)	B
R595	7030003640	S.RESISTOR ERJ3GEYJ 473 V (47 kΩ)	B
H596	7030003540	S.RESISTOR ERJ3GEYJ 682 V (6.8 kΩ)	B
R601	7030009851	S.RESISTOR ERA3YED 271V	T
R602	7030003470	S.RESISTOR ERJ3GEYJ 182 V (1.8 kΩ)	T
R606	7030003360	S.RESISTOR ERJ3GEYJ 221 V (220 Ω)	T
R607	7030003480	S.RESISTOR ERJ3GEYJ 222 V (2.2 kΩ)	T
R608	7030007230	S.RESISTOR ERA3YED 102V	T
R651	7030007230	S.RESISTOR ERA3YED 102V	B
R652	7030003360	S.RESISTOR ERJ3GEYJ 221 V (220 Ω)	T
R653	7030007230	S.RESISTOR ERA3YED 102V	T
R654	7030007230	S.RESISTOR ERA3YED 102V	T
R656	7030003800	S.RESISTOR ERJ3GEYJ 105 V (1 MΩ)	T
R657	7030003320	S.RESISTOR ERJ3GEYJ 101 V (100 Ω)	T
R661	7030007220	S.RESISTOR ERA3YED 202V	T
R662	7030007220	S.RESISTOR ERA3YED 202V	T
R663	7030007220	S.RESISTOR ERA3YED 202V	T
R664	7030007220	S.RESISTOR ERA3YED 202V	T
R665	7030007220	S.RESISTOR ERA3YED 202V	T
R666	7030007220	S.RESISTOR ERA3YED 202V	T
R667	7030007220	S.RESISTOR ERA3YED 202V	T
R668	7030007220	S.RESISTOR ERA3YED 202V	T

[RXPLL-B UNIT]

REF NO.	ORDER NO.	DESCRIPTION	M.
R669	7030007200	S.RESISTOR ERA3YEB 202V	T
R670	7030007200	S.RESISTOR ERA3YEB 202V	T
R671	7030007200	S.RESISTOR ERA3YEB 202V	T
R673	7030007230	S.RESISTOR ERA3YED 102V	T
R674	7030007230	S.RESISTOR ERA3YED 102V	T
R675	7030007230	S.RESISTOR ERA3YED 102V	T
R676	7030007230	S.RESISTOR ERA3YED 102V	T
R677	7030007230	S.RESISTOR ERA3YED 102V	T
R678	7030007230	S.RESISTOR ERA3YED 102V	T
R679	7030007210	S.RESISTOR ERA3YEB 102V	T
R680	7030007210	S.RESISTOR ERA3YEB 102V	T
R681	7030007210	S.RESISTOR ERA3YEB 102V	T
R683	7030003860	S.RESISTOR ERJ3GE JPW V	B
R685	7030003460	S.RESISTOR ERJ3GEYJ 152 V (1.5 kΩ)	T
R686	7030003320	S.RESISTOR ERJ3GEYJ 101 V (100 Ω)	T
R687	7030003470	S.RESISTOR ERJ3GEYJ 182 V (1.8 kΩ)	T
R688	7030003480	S.RESISTOR ERJ3GEYJ 222 V (2.2 kΩ)	T
R689	7030003360	S.RESISTOR ERJ3GEYJ 221 V (220 Ω)	T
R690	7030009851	S.RESISTOR ERA3YED 271V	T
R691	7030003230	S.RESISTOR ERJ3GEYJ 180 V (18 Ω)	T
R692	7030009851	S.RESISTOR ERA3YED 271V	T
R693	7030003360	S.RESISTOR ERJ3GEYJ 221 V (220 Ω)	T
R704	7030009841	S.RESISTOR ERA3YHD 330V	T
R705	7030003600	S.RESISTOR ERJ3GEYJ 223 V (22 kΩ)	T
R706	7030005321	S.RESISTOR ERA3YED 103V	T
R707	7030009861	S.RESISTOR ERA3YED 471V	T
R708	7030003410	S.RESISTOR ERJ3GEYJ 561 V (560 Ω)	T
R709	7030007860	S.RESISTOR ERJ3GEYJ 8R2V (8.2 Ω)	T
R710	7030003410	S.RESISTOR ERJ3GEYJ 561 V (560 Ω)	T
R711	7030003320	S.RESISTOR ERJ3GEYJ 101 V (100 Ω)	T
R1000	7030003320	S.RESISTOR ERJ3GEYJ 101 V (100 Ω)	B
R1003	7030010980	S.RESISTOR ERA3YHD 470V	T
R1004	7030007230	S.RESISTOR ERA3YED 102V	B
R1005	7030003550	S.RESISTOR ERJ3GEYJ 822 V (8.2 kΩ)	T
R1006	7030007230	S.RESISTOR ERA3YED 102V	T
R1007	7030004030	S.RESISTOR ERJ3GEYJ 5R6 V (5.6 Ω)	B
R1008	7030003240	S.RESISTOR ERJ3GEYJ 220 V (22 Ω)	T
R1009	7030010980	S.RESISTOR ERA3YHD 470V	T
R1010	7030010980	S.RESISTOR ERA3YHD 470V	T
R1011	7030003320	S.RESISTOR ERJ3GEYJ 101 V (100 Ω)	B
R1012	7030003320	S.RESISTOR ERJ3GEYJ 101 V (100 Ω)	B
R1013	7030007230	S.RESISTOR ERA3YED 102V	B
R1014	7030007230	S.RESISTOR ERA3YED 102V	B
R1015	7030003530	S.RESISTOR ERJ3GEYJ 562 V (5.6 kΩ)	B
R1016	7030003530	S.RESISTOR ERJ3GEYJ 562 V (5.6 kΩ)	B
R1017	7030003530	S.RESISTOR ERJ3GEYJ 562 V (5.6 kΩ)	B
R1020	7030003390	S.RESISTOR ERJ3GEYJ 391 V (390 Ω)	T
R1021	7030003220	S.RESISTOR ERJ3GEYJ 150 V (15 Ω)	T
R1022	7030003390	S.RESISTOR ERJ3GEYJ 391 V (390 Ω)	T
R1023	7030010980	S.RESISTOR ERA3YHD 470V	B
R1024	7030003200	S.RESISTOR ERJ3GEYJ 100 V (10 Ω)	B
R1025	7030003300	S.RESISTOR ERJ3GEYJ 680 V (68 Ω)	T
R1026	7030003480	S.RESISTOR ERJ3GEYJ 222 V (2.2 kΩ)	B
R1051	7030003800	S.RESISTOR ERJ3GEYJ 105 V (1 MΩ)	T
R1054	7030010980	S.RESISTOR ERA3YHD 470V	T
R1055	7030000010	S.RESISTOR MCR10EZJ JPW (000)	T
R1056	7030000010	S.RESISTOR MCR10EZJ JPW (000)	T
R1071	7030010980	S.RESISTOR ERA3YHD 470V	B
R1101	7310004860	S.TRIMMER EVM-3YSX50 B53 (502)	T
R1102	7030005871	S.RESISTOR ERA3YKD 104V (100 kΩ)	B
R1103	7030007680	S.RESISTOR ERJ8ENF 47R0V (47 Ω)	T
R1104	7030007680	S.RESISTOR ERJ8ENF 47R0V (47 Ω)	T
R1105	7030003500	S.RESISTOR ERJ3GEYJ 332 V (3.3 kΩ)	T
R1106	7030009620	S.RESISTOR ERJ12YJ120U (12 Ω)	B
R1107	7030010980	S.RESISTOR ERA3YHD 470V	T
R1109	7030007180	S.RESISTOR ERJ12YJ150U (15 Ω)	B
R1110	7030003480	S.RESISTOR ERJ3GEYJ 222 V (2.2 kΩ)	B
R1111	7030003480	S.RESISTOR ERJ3GEYJ 222 V (2.2 kΩ)	T
R1113	7030003480	S.RESISTOR ERJ3GEYJ 222 V (2.2 kΩ)	T
R1114	7030004040	S.RESISTOR ERJ3GEYJ 4R7 V (4.7 Ω)	T
R1115	7030006240	S.RESISTOR ERJ12YJ181U (180 Ω)	B
R1116	7030007230	S.RESISTOR ERA3YED 102V	T
R1117	7030004040	S.RESISTOR ERJ3GEYJ 4R7 V (4.7 Ω)	T
R1118	7030003480	S.RESISTOR ERJ3GEYJ 222 V (2.2 kΩ)	T
R1119	7030003470	S.RESISTOR ERJ3GEYJ 182 V (1.8 kΩ)	T
R1120	7030006070	S.RESISTOR ERJ12YJ101U (100 Ω)	B
R1121	7030003240	S.RESISTOR ERJ3GEYJ 220 V (22 Ω)	T
R1122	7030010980	S.RESISTOR ERA3YHD 470V	T
R1123	7030003480	S.RESISTOR ERJ3GEYJ 222 V (2.2 kΩ)	T
R1124	7030003460	S.RESISTOR ERJ3GEYJ 152 V (1.5 kΩ)	T
R1125	7030003420	S.RESISTOR ERJ3GEYJ 681 V (680 Ω)	B
R1126	7030003200	S.RESISTOR ERJ3GEYJ 100 V (10 Ω)	T
R1127	7030010980	S.RESISTOR ERA3YHD 470V	T
R1128	7030003470	S.RESISTOR ERJ3GEYJ 182 V (1.8 kΩ)	T
R1129	7030003470	S.RESISTOR ERJ3GEYJ 182 V (1.8 kΩ)	T
R1130	7030003480	S.RESISTOR ERJ3GEYJ 222 V (2.2 kΩ)	T
R1131	7030003640	S.RESISTOR ERJ3GEYJ 473 V (47 kΩ)	B
R1132	7310004860	S.TRIMMER EVM-3YSX50 B53 (502)	T

M.=Mounted side (T: Mounted on the Top side, B: Mounted on the Bottom side)

S.=Surface mount

[RXPLL-B UNIT]

REF NO.	ORDER NO.	DESCRIPTION	M.
R1133	7030003500	S.RESISTOR ERJ3GEYJ 332 V (3.3 kΩ)	T
R1134	7030003640	S.RESISTOR ERJ3GEYJ 473 V (47 kΩ)	T
R1135	7030005871	S.RESISTOR ERA3YKD 104V (100 kΩ)	T
R1203	7030000010	S.RESISTOR MCR10EZJH JPW (000)	T
R1211	7030003860	S.RESISTOR ERJ3GE JPW V	T
R1212	7030003860	S.RESISTOR ERJ3GE JPW V	T
R1220	7030010980	S.RESISTOR ERA3YHD 470V	T
R1221	7030007230	S.RESISTOR ERA3YED 102V	T
R1222	7030003530	S.RESISTOR ERJ3GEYJ 562 V (5.6 kΩ)	T
R1223	7030010980	S.RESISTOR ERA3YHD 470V	T
R1224	7030007230	S.RESISTOR ERA3YED 102V	T
R1225	7030003530	S.RESISTOR ERJ3GEYJ 562 V (5.6 kΩ)	T
R1226	7030003410	S.RESISTOR ERJ3GEYJ 561 V (560 Ω)	T
R1227	7030003410	S.RESISTOR ERJ3GEYJ 561 V (560 Ω)	T
R1228	7310004860	S.TRIMMER EVM-3YSX50 B53 (502)	T
R1229	7030003480	S.RESISTOR ERJ3GEYJ 222 V (2.2 kΩ)	B
R1230	7030003480	S.RESISTOR ERJ3GEYJ 222 V (2.2 kΩ)	B
R1231	7030003480	S.RESISTOR ERJ3GEYJ 222 V (2.2 kΩ)	B
R1232	7030003600	S.RESISTOR ERJ3GEYJ 223 V (22 kΩ)	T
R1233	7030010980	S.RESISTOR ERA3YHD 470V	B
R1301	7030010980	S.RESISTOR ERA3YHD 470V	B
R1302	7030003860	S.RESISTOR ERJ3GE JPW V	T
R1304	7030003620	S.RESISTOR ERJ3GEYJ 333 V (33 kΩ)	T
R1306	7030006230	S.RESISTOR ERJ12YJ151U (150 Ω)	B
R1307	7030003300	S.RESISTOR ERJ3GEYJ 680 V (68 Ω)	T
R1357	7030007230	S.RESISTOR ERA3YED 102V	B
R1358	7030003530	S.RESISTOR ERJ3GEYJ 562 V (5.6 kΩ)	B
R1359	7030010980	S.RESISTOR ERA3YHD 470V	T
R1360	7030007230	S.RESISTOR ERA3YED 102V	B
R1361	7030003380	S.RESISTOR ERJ3GEYJ 331 V (330 Ω)	T
R1362	7030005871	S.RESISTOR ERA3YKD 104V (100 kΩ)	B
R1401	7030003200	S.RESISTOR ERJ3GEYJ 100 V (10 Ω)	T
R1402	7030003300	S.RESISTOR ERJ3GEYJ 680 V (68 Ω)	T
R1403	7030007230	S.RESISTOR ERA3YED 102V	T
R1404	7030009861	S.RESISTOR ERA3YED 471V	T
R1405	7030003340	S.RESISTOR ERJ3GEYJ 151 V (150 Ω)	T
R1406	7030009591	S.RESISTOR ERA3YED 472V	T
R1407	7030003550	S.RESISTOR ERJ3GEYJ 822 V (8.2 kΩ)	T
R1408	7030003200	S.RESISTOR ERJ3GEYJ 100 V (10 Ω)	T
R1409	7030009591	S.RESISTOR ERA3YED 472V	T
R1410	7030006091	S.RESISTOR ERA3YED 822V	T
R1411	7030005871	S.RESISTOR ERA3YKD 104V (100 kΩ)	T
R1412	7030003200	S.RESISTOR ERJ3GEYJ 100 V (10 Ω)	T
R1413	7030003200	S.RESISTOR ERJ3GEYJ 100 V (10 Ω)	T
R1414	7030005871	S.RESISTOR ERA3YKD 104V (100 kΩ)	B
R1415	7030010980	S.RESISTOR ERA3YHD 470V	T
R1416	7030003320	S.RESISTOR ERJ3GEYJ 101 V (100 Ω)	B
R1417	7030000010	S.RESISTOR MCR10EZJH JPW (000)	B
R1418	7030000010	S.RESISTOR MCR10EZJH JPW (000)	B
R1419	7030003860	S.RESISTOR ERJ3GE JPW V	T
R1501	7030010980	S.RESISTOR ERA3YHD 470V	T
R1502	7030009841	S.RESISTOR ERA3YHD 330V	T
R1503	7030009851	S.RESISTOR ERA3YED 271V	T
R1504	7030011050	S.RESISTOR ERA3YHD 100V	T
R1505	7030006091	S.RESISTOR ERA3YED 822V	B
R1506	7030007230	S.RESISTOR ERA3YED 102V	T
R1507	7030007230	S.RESISTOR ERA3YED 102V	T
R1508	7030007230	S.RESISTOR ERA3YED 102V	T
R1509	7030007230	S.RESISTOR ERA3YED 102V	T
R1510	7030005321	S.RESISTOR ERA3YED 103V	T
R1511	7030009861	S.RESISTOR ERA3YED 471V	T
R1512	7030003380	S.RESISTOR ERJ3GEYJ 331 V (330 Ω)	T
R1513	7030003380	S.RESISTOR ERJ3GEYJ 331 V (330 Ω)	T
R1514	7030005321	S.RESISTOR ERA3YED 103V	T
R1515	7030005321	S.RESISTOR ERA3YED 103V	T
R1516	7310002690	S.TRIMMER RV-145 (RH03A3A13X0CA) 102	T
R1517	7030005321	S.RESISTOR ERA3YED 103V	T
R1518	7030005321	S.RESISTOR ERA3YED 103V	T
R1519	7030005321	S.RESISTOR ERA3YED 103V	T
R1520	7030005321	S.RESISTOR ERA3YED 103V	T
R1521	7030010980	S.RESISTOR ERA3YHD 470V	T
R1522	7030009841	S.RESISTOR ERA3YHD 330V	T
R1523	7030009851	S.RESISTOR ERA3YED 271V	T
R1524	7030011050	S.RESISTOR ERA3YHD 100V	T
R1525	7030007230	S.RESISTOR ERA3YED 102V	T
R1526	7030003460	S.RESISTOR ERJ3GEYJ 152 V (1.5 kΩ)	B
R1527	7030007230	S.RESISTOR ERA3YED 102V	T
R1528	7030007230	S.RESISTOR ERA3YED 102V	T
R1529	7030007230	S.RESISTOR ERA3YED 102V	T
R1530	7030003380	S.RESISTOR ERJ3GEYJ 331 V (330 Ω)	T
R1531	7030003380	S.RESISTOR ERJ3GEYJ 331 V (330 Ω)	T
R1532	7030005321	S.RESISTOR ERA3YED 103V	T
R1533	7030005321	S.RESISTOR ERA3YED 103V	T
R1534	7030005321	S.RESISTOR ERA3YED 103V	T
R1535	7030005321	S.RESISTOR ERA3YED 103V	T
R1536	7030005321	S.RESISTOR ERA3YED 103V	T
R1537	7030003320	S.RESISTOR ERJ3GEYJ 101 V (100 Ω)	T
R1538	7030003320	S.RESISTOR ERJ3GEYJ 101 V (100 Ω)	T

M.=Mounted side (T: Mounted on the Top side, B: Mounted on the Bottom side)

[RXPLL-B UNIT]

REF NO.	ORDER NO.	DESCRIPTION	M.
R1539	7030008061	S.RESISTOR ERA3YED 222V	B
R1540	7030010390	S.RESISTOR ERA3YED 821V	B
R1541	7030003320	S.RESISTOR ERJ3GEYJ 101 V (100 Ω)	T
R1542	7030003320	S.RESISTOR ERJ3GEYJ 101 V (100 Ω)	T
R1543	7030009691	S.RESISTOR ERA3YED 101V (100 Ω)	B
R1651	7030003380	S.RESISTOR ERJ3GEYJ 331 V (330 Ω)	B
R1652	7030003220	S.RESISTOR ERJ3GEYJ 150 V (15 Ω)	B
R1653	7030003380	S.RESISTOR ERJ3GEYJ 331 V (330 Ω)	B
R1654	7030010980	S.RESISTOR ERA3YHD 470V	B
R1655	7030009861	S.RESISTOR ERA3YED 471V	B
R1656	7030003630	S.RESISTOR ERJ3GEYJ 393 V (39 kΩ)	B
R1657	7030005871	S.RESISTOR ERA3YKD 104V (100 kΩ)	T
R1658	7030003320	S.RESISTOR ERJ3GEYJ 101 V (100 Ω)	T
R1659	7030009691	S.RESISTOR ERA3YED 101V (100 Ω)	T
R1660	7030009691	S.RESISTOR ERA3YED 101V (100 Ω)	T
R1661	7030005321	S.RESISTOR ERA3YED 103V	T
R1662	7030005321	S.RESISTOR ERA3YED 103V	T
R1663	7030005321	S.RESISTOR ERA3YED 103V	T
R1664	7030005321	S.RESISTOR ERA3YED 103V	T
R1665	7030003320	S.RESISTOR ERJ3GEYJ 101 V (100 Ω)	T
R1667	7030003360	S.RESISTOR ERJ3GEYJ 221 V (220 Ω)	T
R1668	7030003360	S.RESISTOR ERJ3GEYJ 221 V (220 Ω)	T
R1670	7030003800	S.RESISTOR ERJ3GEYJ 105 V (1 MΩ)	T
R1673	7030007230	S.RESISTOR ERA3YED 102V	B
R1674	7030009851	S.RESISTOR ERA3YED 271V	B
R1675	7030009591	S.RESISTOR ERA3YED 472V	T
R1677	7030009591	S.RESISTOR ERA3YED 472V	T
R1701	7030003360	S.RESISTOR ERJ3GEYJ 221 V (220 Ω)	T
R1703	7030003360	S.RESISTOR ERJ3GEYJ 221 V (220 Ω)	T
R1704	7030003360	S.RESISTOR ERJ3GEYJ 221 V (220 Ω)	T
R1706	7030003360	S.RESISTOR ERJ3GEYJ 221 V (220 Ω)	T
R1707	7030003360	S.RESISTOR ERJ3GEYJ 221 V (220 Ω)	T
R1708	7030003360	S.RESISTOR ERJ3GEYJ 221 V (220 Ω)	T
R1709	7030003480	S.RESISTOR ERJ3GEYJ 222 V (2.2 kΩ)	T
R1710	7030003480	S.RESISTOR ERJ3GEYJ 222 V (2.2 kΩ)	T
R1711	7030003540	S.RESISTOR ERJ3GEYJ 682 V (6.8 kΩ)	T
R1712	7030003540	S.RESISTOR ERJ3GEYJ 682 V (6.8 kΩ)	T
R1713	7030003660	S.RESISTOR ERJ3GEYJ 683 V (68 kΩ)	T
R1714	7030003660	S.RESISTOR ERJ3GEYJ 683 V (68 kΩ)	T
R1716	7030007230	S.RESISTOR ERA3YED 102V	T
R1717	7030007230	S.RESISTOR ERA3YED 102V	T
R1718	7030007230	S.RESISTOR ERA3YED 102V	T
C1	4030011600	S.CERAMIC C1608 JB 1E 104K-T	T
C2	4030006880	S.CERAMIC C1608 JB 1H 472K-T	T
C14	4030006880	S.CERAMIC C1608 JB 1H 472K-T	T
C15	4030006880	S.CERAMIC C1608 JB 1H 472K-T	T
C16	4030006880	S.CERAMIC C1608 JB 1H 472K-T	T
C17	4030006880	S.CERAMIC C1608 JB 1H 472K-T	T
C18	4030006880	S.CERAMIC C1608 JB 1H 472K-T	T
C19	4030006880	S.CERAMIC C1608 JB 1H 472K-T	T
C20	4030006880	S.CERAMIC C1608 JB 1H 472K-T	T
C21	4030006880	S.CERAMIC C1608 JB 1H 472K-T	T
C22	4030006880	S.CERAMIC C1608 JB 1H 472K-T	T
C30	4030011600	S.CERAMIC C1608 JB 1E 104K-T	T
C31	4030011600	S.CERAMIC C1608 JB 1E 104K-T	T
C32	4030011600	S.CERAMIC C1608 JB 1E 104K-T	T
C51	4510004640	S.ELECTROLYTIC ECEV1CA470SP	T
C52	4030011600	S.CERAMIC C1608 JB 1E 104K-T	T
C53	4030011600	S.CERAMIC C1608 JB 1E 104K-T	T
C54	4510006220	S.ELECTROLYTIC ECEV1CA101UP	T
C61	4510004640	S.ELECTROLYTIC ECEV1CA470SP	T
C62	4030011600	S.CERAMIC C1608 JB 1E 104K-T	B
C63	4030011600	S.CERAMIC C1608 JB 1E 104K-T	B
C64	4510006220	S.ELECTROLYTIC ECEV1CA101UP	T
C101	4030006880	S.CERAMIC C1608 JB 1H 472K-T	T
C102	4030011600	S.CERAMIC C1608 JB 1E 104K-T	T
C103	4510004630	S.ELECTROLYTIC ECEV1CA100SH	T
C104	4030011600	S.CERAMIC C1608 JB 1E 104K-T	T
C105	4030011600	S.CERAMIC C1608 JB 1E 104K-T	T
C106	4030011600	S.CERAMIC C1608 JB 1E 104K-T	T
C107	4030011600	S.CERAMIC C1608 JB 1E 104K-T	T
C108	4030011600	S.CERAMIC C1608 JB 1E 104K-T	T
C109	4030011600	S.CERAMIC C1608 JB 1E 104K-T	T
C110	4030011600	S.CERAMIC C1608 JB 1E 104K-T	T
C111	4030011600	S.CERAMIC C1608 JB 1E 104K-T	T
C112	4030011600	S.CERAMIC C1608 JB 1E 104K-T	T
C114	4030011600	S.CERAMIC C1608 JB 1E 104K-T	T
C115	4030011600	S.CERAMIC C1608 JB 1E 104K-T	T
C116	4030011600	S.CERAMIC C1608 JB 1E 104K-T	T
C117	4030011600	S.CERAMIC C1608 JB 1E 104K-T	T
C118	4030011600	S.CERAMIC C1608 JB 1E 104K-T	T
C120	4030006880	S.CERAMIC C1608 JB 1H 472K-T	T
C121	4030011600	S.CERAMIC C1608 JB 1E 104K-T	T
C125	4030011600	S.CERAMIC C1608 JB 1E 104K-T	T
C129	4030011600	S.CERAMIC C1608 JB 1E 104K-T	T
C130	4030017810	S.CERAMIC C1608 CH 1H 102J-T	B

S.=Surface mount

[RXPLL-B UNIT]

REF NO.	ORDER NO.	DESCRIPTION	M.
C131	4030011600	S.CERAMIC C1608 JB 1E 104K-T	T
C132	4030011600	S.CERAMIC C1608 JB 1E 104K-T	T
C133	4030006880	S.CERAMIC C1608 JB 1H 472K-T	B
C134	4030006880	S.CERAMIC C1608 JB 1H 472K-T	B
C135	4030006880	S.CERAMIC C1608 JB 1H 472K-T	T
C136	4030006880	S.CERAMIC C1608 JB 1H 472K-T	T
C137	4030006880	S.CERAMIC C1608 JB 1H 472K-T	T
C138	4030006880	S.CERAMIC C1608 JB 1H 472K-T	T
C139	4030006880	S.CERAMIC C1608 JB 1H 472K-T	B
C150	4030006880	S.CERAMIC C1608 JB 1H 472K-T	B
C151	4550006700	S.TANTALUM ECST1AY106R	B
C152	4030007070	S.CERAMIC C1608 CH 1H 330J-T	T
C153	4030009910	S.CERAMIC C1608 CH 1H 040B-T	T
C154	4610001850	S.TRIMMER TZB4R200AB10R00	T
C155	4030016550	S.CERAMIC CM105 CH 151G 50AT	T
C156	4030016550	S.CERAMIC CM105 CH 151G 50AT	T
C157	4030016550	S.CERAMIC CM105 CH 151G 50AT	T
C158	4030006880	S.CERAMIC C1608 JB 1H 472K-T	T
C159	4030006880	S.CERAMIC C1608 JB 1H 472K-T	B
C161	4510004630	S.ELECTROLYTIC ECEV1CA100SR	T
C162	4030009920	S.CERAMIC C1608 CH 1H 050B-T	B
C163	4030011600	S.CERAMIC C1608 JB 1E 104K-T	B
C164	4030006880	S.CERAMIC C1608 JB 1H 472K-T	B
C165	4030006880	S.CERAMIC C1608 JB 1H 472K-T	B
C166	4030011600	S.CERAMIC C1608 JB 1E 104K-T	B
C167	4030006880	S.CERAMIC C1608 JB 1H 472K-T	B
C201	4030011340	S.CERAMIC C1608 CH 1H 471J-T	T
C202	4510004650	S.ELECTROLYTIC ECEV1EA4R7SR	T
C203	4030006900	S.CERAMIC C1608 JB 1H 103K-T	T
C204	4030006880	S.CERAMIC C1608 JB 1H 472K-T	T
C205	4030006880	S.CERAMIC C1608 JB 1H 472K-T	T
C206	4030006880	S.CERAMIC C1608 JB 1H 472K-T	T
C207	4030007030	S.CERAMIC C1608 CH 1H 150J-T	B
C208	4030007030	S.CERAMIC C1608 CH 1H 150J-T	T
C210	4550006590	S.TANTALUM ECST1CY684R	T
C213	4030006880	S.CERAMIC C1608 JB 1H 472K-T	T
C214	4030006900	S.CERAMIC C1608 JB 1H 103K-T	T
C215	4510004630	S.ELECTROLYTIC ECEV1CA100SR	T
C216	4550006300	S.TANTALUM ECST1AY475R	T
C217	4550006300	S.TANTALUM ECST1AY475R	T
C220	4030007120	S.CERAMIC C1608 CH 1H 820J-T	T
C221	4030007010	S.CERAMIC C1608 CH 1H 100D-T	T
C222	4610001160	S.TRIMMER ECR-JA010 A11W	T
C223	4030007080	S.CERAMIC C1608 CH 1H 390J-T	T
C224	4030007030	S.CERAMIC C1608 CH 1H 150J-T	T
C225	4030007010	S.CERAMIC C1608 CH 1H 100D-T	T
C226	4030006880	S.CERAMIC C1608 JB 1H 472K-T	T
C227	4030009520	S.CERAMIC C1608 CH 1H 020B-T	T
C228	4510004630	S.ELECTROLYTIC ECEV1CA100SR	T
C230	4030007090	S.CERAMIC C1608 CH 1H 470J-T	T
C231	4030009920	S.CERAMIC C1608 CH 1H 050B-T	T
C232	4610001160	S.TRIMMER ECR-JA010 A11W	T
C233	4030007070	S.CERAMIC C1608 CH 1H 330J-T	T
C234	4030007020	S.CERAMIC C1608 CH 1H 120J-T	T
C235	4030009920	S.CERAMIC C1608 CH 1H 050B-T	T
C236	4030006880	S.CERAMIC C1608 JB 1H 472K-T	T
C237	4030009520	S.CERAMIC C1608 CH 1H 020B-T	T
C238	4510004630	S.ELECTROLYTIC ECEV1CA100SR	T
C240	4030007080	S.CERAMIC C1608 CH 1H 390J-T	T
C241	4030009920	S.CERAMIC C1608 CH 1H 050B-T	T
C242	4540000090	S.TRIMMER ECR-JA006A11W	T
C243	4030007060	S.CERAMIC C1608 CH 1H 270J-T	T
C244	4030007010	S.CERAMIC C1608 CH 1H 100D-T	T
C245	4030006980	S.CERAMIC C1608 CH 1H 070D-T	T
C246	4030006880	S.CERAMIC C1608 JB 1H 472K-T	T
C247	4030009520	S.CERAMIC C1608 CH 1H 020B-T	T
C248	4510004630	S.ELECTROLYTIC ECEV1CA100SR	T
C250	4030007070	S.CERAMIC C1608 CH 1H 330J-T	T
C251	4030009510	S.CERAMIC C1608 CH 1H 010B-T	T
C252	4540000090	S.TRIMMER ECR-JA006A11W	T
C253	4030007080	S.CERAMIC C1608 CH 1H 390J-T	T
C254	4030009920	S.CERAMIC C1608 CH 1H 050B-T	T
C255	4030009530	S.CERAMIC C1608 CH 1H 030B-T	T
C256	4030006880	S.CERAMIC C1608 JB 1H 472K-T	T
C257	4030009520	S.CERAMIC C1608 CH 1H 020B-T	T
C258	4510004630	S.ELECTROLYTIC ECEV1CA100SR	T
C260	4030007110	S.CERAMIC C1608 CH 1H 680J-T	T
C261	4030009910	S.CERAMIC C1608 CH 1H 040B-T	T
C262	4540000090	S.TRIMMER ECR-JA006A11W	T
C263	4030007080	S.CERAMIC C1608 CH 1H 390J-T	T
C264	4030009920	S.CERAMIC C1608 CH 1H 050B-T	T
C265	4030007010	S.CERAMIC C1608 CH 1H 100D-T	T
C266	4030006880	S.CERAMIC C1608 JB 1H 472K-T	T
C267	4030009920	S.CERAMIC C1608 CH 1H 050B-T	T
C268	4510004630	S.ELECTROLYTIC ECEV1CA100SR	T
C270	4030007080	S.CERAMIC C1608 CH 1H 390J-T	T
C272	4540000090	S.TRIMMER ECR-JA006A11W	T
C273	4030007070	S.CERAMIC C1608 CH 1H 330J-T	T

[RXPLL-B UNIT]

REF NO.	ORDER NO.	DESCRIPTION	M.
C274	4030006980	S.CERAMIC C1608 CH 1H 070D-T	T
C275	4030009530	S.CERAMIC C1608 CH 1H 030B-T	T
C276	4030006880	S.CERAMIC C1608 JB 1H 472K-T	T
C277	4030009530	S.CERAMIC C1608 CH 1H 030B-T	T
C278	4510004630	S.ELECTROLYTIC ECEV1CA100SR	T
C283	4030017810	S.CERAMIC C1608 CH 1H 102J-T	T
C284	4030006880	S.CERAMIC C1608 JB 1H 472K-T	T
C285	4030017810	S.CERAMIC C1608 CH 1H 102J-T	T
C286	4030006880	S.CERAMIC C1608 JB 1H 472K-T	T
C287	4030017810	S.CERAMIC C1608 CH 1H 102J-T	T
C288	4030006880	S.CERAMIC C1608 JB 1H 472K-T	T
C289	4030017810	S.CERAMIC C1608 CH 1H 102J-T	T
C290	4030006880	S.CERAMIC C1608 JB 1H 472K-T	T
C291	4030017810	S.CERAMIC C1608 CH 1H 102J-T	T
C292	4030006880	S.CERAMIC C1608 JB 1H 472K-T	T
C293	4030017810	S.CERAMIC C1608 CH 1H 102J-T	T
C294	4030006880	S.CERAMIC C1608 JB 1H 472K-T	T
C301	4030006880	S.CERAMIC C1608 JB 1H 472K-T	T
C302	4030006880	S.CERAMIC C1608 JB 1H 472K-T	T
C303	4030006880	S.CERAMIC C1608 JB 1H 472K-T	B
C304	4030006880	S.CERAMIC C1608 JB 1H 472K-T	B
C305	4030006880	S.CERAMIC C1608 JB 1H 472K-T	B
C306	4030006880	S.CERAMIC C1608 JB 1H 472K-T	B
C309	4030017810	S.CERAMIC C1608 CH 1H 102J-T	T
C310	4030011600	S.CERAMIC C1608 JB 1E 104K-T	T
C311	4510004640	S.ELECTROLYTIC ECEV1CA470SP	T
C331	4030007110	S.CERAMIC C1608 CH 1H 680J-T	T
C332	4030007160	S.CERAMIC C1608 CH 1H 181J-T	T
C333	4030007110	S.CERAMIC C1608 CH 1H 680J-T	T
C334	4030007050	S.CERAMIC C1608 CH 1H 220J-T	T
C335	4030006980	S.CERAMIC C1608 CH 1H 070D-T	T
C336	4030007030	S.CERAMIC C1608 CH 1H 150J-T	T
C337	4030007050	S.CERAMIC C1608 CH 1H 220J-T	T
C341	4030006880	S.CERAMIC C1608 JB 1H 472K-T	T
C342	4030006880	S.CERAMIC C1608 JB 1H 472K-T	T
C344	4030011600	S.CERAMIC C1608 JB 1E 104K-T	T
C351	4030017810	S.CERAMIC C1608 CH 1H 102J-T	T
C352	4030011600	S.CERAMIC C1608 JB 1E 104K-T	T
C353	4510004640	S.ELECTROLYTIC ECEV1CA470SP	T
C354	4030006880	S.CERAMIC C1608 JB 1H 472K-T	T
C355	4030006880	S.CERAMIC C1608 JB 1H 472K-T	T
C356	4030006880	S.CERAMIC C1608 JB 1H 472K-T	T
C357	4030006880	S.CERAMIC C1608 JB 1H 472K-T	T
C358	4030006880	S.CERAMIC C1608 JB 1H 472K-T	B
C359	4030006880	S.CERAMIC C1608 JB 1H 472K-T	B
C360	4030006880	S.CERAMIC C1608 JB 1H 472K-T	B
C361	4030006880	S.CERAMIC C1608 JB 1H 472K-T	T
C363	4030006880	S.CERAMIC C1608 JB 1H 472K-T	T
C364	4030017810	S.CERAMIC C1608 CH 1H 102J-T	T
C365	4030006880	S.CERAMIC C1608 JB 1H 472K-T	T
C421	4030006880	S.CERAMIC C1608 JB 1H 472K-T	T
C423	4030006880	S.CERAMIC C1608 JB 1H 472K-T	T
C426	4030006880	S.CERAMIC C1608 JB 1H 472K-T	B
C427	4030006880	S.CERAMIC C1608 JB 1H 472K-T	T
C441	4030007040	S.CERAMIC C1608 CH 1H 180J-T	T
C442	4030007040	S.CERAMIC C1608 CH 1H 180J-T	T
C443	4030007020	S.CERAMIC C1608 CH 1H 120J-T	T
C444	4030007080	S.CERAMIC C1608 CH 1H 390J-T	T
C445	4030011770	S.CERAMIC C1608 CH 1H 060B-T	T
C446	4030007060	S.CERAMIC C1608 CH 1H 270J-T	T
C447	4030007110	S.CERAMIC C1608 CH 1H 680J-T	T
C448	4030006880	S.CERAMIC C1608 JB 1H 472K-T	T
C449	4030006880	S.CERAMIC C1608 JB 1H 472K-T	T
C451	4030007110	S.CERAMIC C1608 CH 1H 680J-T	T
C452	4030007160	S.CERAMIC C1608 CH 1H 181J-T	T
C453	4030011600	S.CERAMIC C1608 JB 1E 104K-T	T
C501	4030006880	S.CERAMIC C1608 JB 1H 472K-T	T
C502	4030011600	S.CERAMIC C1608 JB 1E 104K-T	T
C503	4510004630	S.ELECTROLYTIC ECEV1CA100SR	T
C504	4030011600	S.CERAMIC C1608 JB 1E 104K-T	T
C506	4030011600	S.CERAMIC C1608 JB 1E 104K-T	T
C507	4030011600	S.CERAMIC C1608 JB 1E 104K-T	T
C509	4030011600	S.CERAMIC C1608 JB 1E 104K-T	T
C510	4030011600	S.CERAMIC C1608 JB 1E 104K-T	T
C511	4030011600	S.CERAMIC C1608 JB 1E 104K-T	T
C512	4030011600	S.CERAMIC C1608 JB 1E 104K-T	T
C513	4030011600	S.CERAMIC C1608 JB 1E 104K-T	T
C514	4030011600	S.CERAMIC C1608 JB 1E 104K-T	T
C515	4030011600	S.CERAMIC C1608 JB 1E 104K-T	T
C516	4030011600	S.CERAMIC C1608 JB 1E 104K-T	T
C517	4030011600	S.CERAMIC C1608 JB 1E 104K-T	T
C518	4030011600	S.CERAMIC C1608 JB 1E 104K-T	T
C519	4030011600	S.CERAMIC C1608 JB 1E 104K-T	T
C520	4030011600	S.CERAMIC C1608 JB 1E 104K-T	T
C521	4030011600	S.CERAMIC C1608 JB 1E 104K-T	T
C525	4030006880	S.CERAMIC C1608 JB 1H 472K-T	T
C526	4030011600	S.CERAMIC C1608 JB 1E 104K-T	T
C531	4030006880	S.CERAMIC C1608 JB 1H 472K-T	T

M.=Mounted side (T: Mounted on the Top side, B: Mounted on the Bottom side)

S.=Surface mount

[RXPLL-B UNIT]

REF NO.	ORDER NO.	DESCRIPTION	M.
C532	4030007070	S.CERAMIC C1608 CH 1H 330J-T	T
C533	4030007110	S.CERAMIC C1608 CH 1H 680J-T	T
C534	4030007110	S.CERAMIC C1608 CH 1H 680J-T	T
C535	4030007070	S.CERAMIC C1608 CH 1H 330J-T	T
C536	4030006880	S.CERAMIC C1608 JB 1H 472K-T	T
C537	4030006880	S.CERAMIC C1608 JB 1H 472K-T	T
C540	4030006880	S.CERAMIC C1608 JB 1H 472K-T	B
C541	4510004630	S.ELECTROLYTIC ECEV1CA100SR	T
C542	4340000260	S.MYLAR ECPU 1C 104MA5	B
C543	4030007050	S.CERAMIC C1608 CH 1H 220J-T	T
C545	4030007060	S.CERAMIC C1608 CH 1H 270J-T	T
C546	4610001160	S.TRIMMER ECR-JA010 A11W	T
C547	4030007130	S.CERAMIC C1608 CH 1H 101J-T	T
C548	4030007030	S.CERAMIC C1608 CH 1H 150J-T	T
C549	4030007020	S.CERAMIC C1608 CH 1H 120J-T	T
C550	4030006880	S.CERAMIC C1608 JB 1H 472K-T	T
C551	4030009510	S.CERAMIC C1608 CH 1H 010B-T	T
C552	4030017810	S.CERAMIC C1608 CH 1H 102J-T	B
C553	4030006880	S.CERAMIC C1608 JB 1H 472K-T	B
C554	4510006220	S.ELECTROLYTIC ECEV1CA101UP	T
C555	4030006880	S.CERAMIC C1608 JB 1H 472K-T	T
C558	4550006300	S.TANTALUM ECST1AY475R	B
C559	4550006590	S.TANTALUM ECST1CY684R	B
C562	4030006880	S.CERAMIC C1608 JB 1H 472K-T	T
C563	4030017810	S.CERAMIC C1608 CH 1H 102J-T	B
C564	4030006880	S.CERAMIC C1608 JB 1H 472K-T	B
C565	4510004640	S.ELECTROLYTIC ECEV1CA470SP	T
C566	4030006880	S.CERAMIC C1608 JB 1H 472K-T	T
C571	4030006880	S.CERAMIC C1608 JB 1H 472K-T	B
C573	4030007040	S.CERAMIC C1608 CH 1H 180J-T	B
C574	4030009510	S.CERAMIC C1608 CH 1H 010B-T	T
C575	4030007040	S.CERAMIC C1608 CH 1H 180J-T	T
C580	4030006880	S.CERAMIC C1608 JB 1H 472K-T	T
C581	4030006880	S.CERAMIC C1608 JB 1H 472K-T	T
C591	4030006880	S.CERAMIC C1608 JB 1H 472K-T	T
C592	4030007060	S.CERAMIC C1608 CH 1H 270J-T	T
C593	4510004630	S.ELECTROLYTIC ECEV1CA100SR	T
C594	4030006880	S.CERAMIC C1608 JB 1H 472K-T	T
C596	4030006880	S.CERAMIC C1608 JB 1H 472K-T	B
C597	4030007050	S.CERAMIC C1608 CH 1H 220J-T	T
C601	4030006880	S.CERAMIC C1608 JB 1H 472K-T	T
C602	4030006880	S.CERAMIC C1608 JB 1H 472K-T	T
C607	4030006880	S.CERAMIC C1608 JB 1H 472K-T	T
C608	4030006880	S.CERAMIC C1608 JB 1H 472K-T	T
C609	4030007100	S.CERAMIC C1608 CH 1H 560J-T	T
C610	4030008750	S.CERAMIC C1608 CH 1H 360J-T	T
C611	4030007140	S.CERAMIC C1608 CH 1H 121J-T	T
C612	4030007020	S.CERAMIC C1608 CH 1H 120J-T	T
C613	4030007110	S.CERAMIC C1608 CH 1H 680J-T	T
C651	4030006880	S.CERAMIC C1608 JB 1H 472K-T	T
C652	4030011600	S.CERAMIC C1608 JB 1E 104K-T	T
C653	4510004630	S.ELECTROLYTIC ECEV1CA100SR	T
C654	4030011600	S.CERAMIC C1608 JB 1E 104K-T	T
C655	4030011600	S.CERAMIC C1608 JB 1E 104K-T	T
C656	4030011600	S.CERAMIC C1608 JB 1E 104K-T	T
C657	4030011600	S.CERAMIC C1608 JB 1E 104K-T	T
C658	4030011600	S.CERAMIC C1608 JB 1E 104K-T	T
C659	4030011600	S.CERAMIC C1608 JB 1E 104K-T	T
C660	4030006880	S.CERAMIC C1608 JB 1H 472K-T	T
C661	4030011600	S.CERAMIC C1608 JB 1E 104K-T	T
C680	4030006880	S.CERAMIC C1608 JB 1H 472K-T	T
C681	4030007160	S.CERAMIC C1608 CH 1H 181J-T	T
C682	4030007140	S.CERAMIC C1608 CH 1H 121J-T	T
C683	4030011330	S.CERAMIC C1608 CH 1H 391J-T	T
C684	4030007080	S.CERAMIC C1608 CH 1H 390J-T	B
C685	4030011280	S.CERAMIC C1608 CH 1H 271J-T	B
C686	4030010760	S.CERAMIC C1608 CH 1H 331J-T	B
C687	4030018580	S.CERAMIC C1608 CH 1H 821J-T	T
C688	4030010760	S.CERAMIC C1608 CH 1H 331J-T	B
C689	4030011600	S.CERAMIC C1608 JB 1E 104K-T	T
C690	4030011600	S.CERAMIC C1608 JB 1E 104K-T	T
C691	4030011600	S.CERAMIC C1608 JB 1E 104K-T	T
C692	4030006880	S.CERAMIC C1608 JB 1H 472K-T	T
C693	4030006880	S.CERAMIC C1608 JB 1H 472K-T	B
C694	4030006880	S.CERAMIC C1608 JB 1H 472K-T	T
C703	4030017810	S.CERAMIC C1608 CH 1H 102J-T	B
C704	4030006880	S.CERAMIC C1608 JB 1H 472K-T	T
C705	4510006220	S.ELECTROLYTIC ECEV1CA101UP	T
C707	4030011600	S.CERAMIC C1608 JB 1E 104K-T	T
C708	4030011600	S.CERAMIC C1608 JB 1E 104K-T	T
C709	4030007070	S.CERAMIC C1608 CH 1H 330J-T	T
C710	4030006880	S.CERAMIC C1608 JB 1H 472K-T	T
C711	4030009540	S.CERAMIC C1608 CH 1H 1R5B-T	B
C712	4030007070	S.CERAMIC C1608 CH 1H 330J-T	T
C713	4030006880	S.CERAMIC C1608 JB 1H 472K-T	T
C1000	4030007050	S.CERAMIC C1608 CH 1H 220J-T	B
C1002	4030006880	S.CERAMIC C1608 JB 1H 472K-T	B
C1003	4030012600	S.CERAMIC C2012 JB 1A 105M-T	T

[RXPLL-B UNIT]

REF NO.	ORDER NO.	DESCRIPTION	M.
C1004	4030011600	S.CERAMIC C1608 JB 1E 104K-T	B
C1005	4030011600	S.CERAMIC C1608 JB 1E 104K-T	T
C1006	4030010210	S.CERAMIC C3216 JB 1C 105M-T	T
C1007	4030006880	S.CERAMIC C1608 JB 1H 472K-T	T
C1008	4030006880	S.CERAMIC C1608 JB 1H 472K-T	T
C1009	4030006880	S.CERAMIC C1608 JB 1H 472K-T	T
C1010	4030012600	S.CERAMIC C2012 JB 1A 105M-T	T
C1011	4030012600	S.CERAMIC C2012 JB 1A 105M-T	T
C1012	4030010210	S.CERAMIC C3216 JB 1C 105M-T	T
C1013	4030012600	S.CERAMIC C2012 JB 1A 105M-T	T
C1014	4030018810	S.CERAMIC C3216 CH 1H 333J-T	B
C1015	4030012600	S.CERAMIC C2012 JB 1A 105M-T	T
C1016	4030012600	S.CERAMIC C2012 JB 1A 105M-T	T
C1017	4030012600	S.CERAMIC C2012 JB 1A 105M-T	T
C1018	4030012600	S.CERAMIC C2012 JB 1A 105M-T	T
C1019	4030012600	S.CERAMIC C2012 JB 1A 105M-T	T
C1020	4030012600	S.CERAMIC C2012 JB 1A 105M-T	B
C1021	4030012600	S.CERAMIC C2012 JB 1A 105M-T	B
C1022	4030006990	S.CERAMIC C1608 CH 1H 080D-T	B
C1023	4030006990	S.CERAMIC C1608 CH 1H 080D-T	B
C1024	4030010210	S.CERAMIC C3216 JB 1C 105M-T	B
C1025	4030010210	S.CERAMIC C3216 JB 1C 105M-T	B
C1026	4030010210	S.CERAMIC C3216 JB 1C 105M-T	T
C1027	4030010210	S.CERAMIC C3216 JB 1C 105M-T	T
C1028	4030006880	S.CERAMIC C1608 JB 1H 472K-T	B
C1029	4030006880	S.CERAMIC C1608 JB 1H 472K-T	T
C1030	4030010210	S.CERAMIC C3216 JB 1C 105M-T	T
C1031	4030012600	S.CERAMIC C2012 JB 1A 105M-T	B
C1033	4550006470	S.TANTALUM TEESVB2 1D 106M8L	B
C1034	4550006470	S.TANTALUM TEESVB2 1D 106M8L	B
C1035	4550006470	S.TANTALUM TEESVB2 1D 106M8L	B
C1036	4030007120	S.CERAMIC C1608 CH 1H 820J-T	T
C1037	4030007090	S.CERAMIC C1608 CH 1H 470J-T	T
C1038	4030017810	S.CERAMIC C1608 CH 1H 102J-T	T
C1039	4030017810	S.CERAMIC C1608 CH 1H 102J-T	T
C1040	4030017810	S.CERAMIC C1608 CH 1H 102J-T	T
C1041	4030006990	S.CERAMIC C1608 CH 1H 080D-T	B
C1048	4030017180	S.CERAMIC UMK107 B 102K Z-T	B
C1049	4030017180	S.CERAMIC UMK107 B 102K Z-T	B
C1050	4030017180	S.CERAMIC UMK107 B 102K Z-T	B
C1051	4030017180	S.CERAMIC UMK107 B 102K Z-T	B
C1052	4030007100	S.CERAMIC C1608 CH 1H 560J-T	T
C1053	4030007110	S.CERAMIC C1608 CH 1H 680J-T	T
C1054	4030007010	S.CERAMIC C1608 CH 1H 100D-T	B
C1055	4030007140	S.CERAMIC C1608 CH 1H 121J-T	T
C1056	4030007050	S.CERAMIC C1608 CH 1H 220J-T	T
C1057	4030007130	S.CERAMIC C1608 CH 1H 101J-T	T
C1060	4030017810	S.CERAMIC C1608 CH 1H 102J-T	T
C1061	4030007090	S.CERAMIC C1608 CH 1H 470J-T	B
C1062	4030007170	S.CERAMIC C1608 CH 1H 221J-T	B
C1063	4030007000	S.CERAMIC C1608 CH 1H 090D-T	B
C1064	4030007090	S.CERAMIC C1608 CH 1H 470J-T	T
C1066	4030007070	S.CERAMIC C1608 CH 1H 330J-T	T
C1067	4030007010	S.CERAMIC C1608 CH 1H 100D-T	T
C1071	4030007100	S.CERAMIC C1608 CH 1H 560J-T	B
C1072	4030007170	S.CERAMIC C1608 CH 1H 221J-T	B
C1073	4030007080	S.CERAMIC C1608 CH 1H 390J-T	B
C1081	4030006990	S.CERAMIC C1608 JB 1H 103K-T	B
C1082	4030006990	S.CERAMIC C1608 JB 1H 103K-T	B
C1083	4030006990	S.CERAMIC C1608 JB 1H 103K-T	B
C1084	4030006880	S.CERAMIC C1608 JB 1H 472K-T	B
C1085	4030006880	S.CERAMIC C1608 JB 1H 472K-T	B
C1091	4030006880	S.CERAMIC C1608 JB 1H 472K-T	T
C1092	4030006880	S.CERAMIC C1608 JB 1H 472K-T	T
C1093	4030006880	S.CERAMIC C1608 JB 1H 472K-T	T
C1101	4030006900	S.CERAMIC C1608 JB 1H 103K-T	T
C1102	4030006900	S.CERAMIC C1608 JB 1H 103K-T	T
C1103	4030011600	S.CERAMIC C1608 JB 1E 104K-T	T
C1104	4030011600	S.CERAMIC C1608 JB 1E 104K-T	T
C1106	4030011600	S.CERAMIC C1608 JB 1E 104K-T	T
C1107	4030011600	S.CERAMIC C1608 JB 1E 104K-T	B
C1109	4030007090	S.CERAMIC C1608 CH 1H 470J-T	T
C1110	4030006900	S.CERAMIC C1608 JB 1H 103K-T	T
C1111	4030011600	S.CERAMIC C1608 JB 1E 104K-T	T
C1112	4030006900	S.CERAMIC C1608 JB 1H 103K-T	T
C1113	4030007010	S.CERAMIC C1608 CH 1H 100D-T	T
C1114	4030006900	S.CERAMIC C1608 JB 1H 103K-T	B
C1115	4030011600	S.CERAMIC C1608 JB 1E 104K-T	T
C1116	4030006900	S.CERAMIC C1608 JB 1H 103K-T	T
C1117	4030007010	S.CERAMIC C1608 CH 1H 100D-T	T
C1118	4030011600	S.CERAMIC C1608 JB 1E 104K-T	T
C1119	4030006880	S.CERAMIC C1608 JB 1H 472K-T	T
C1120	4030006880	S.CERAMIC C1608 JB 1H 472K-T	T
C1121	4030011600	S.CERAMIC C1608 JB 1E 104K-T	T
C1122	4030009530	S.CERAMIC C1608 CH 1H 030B-T	T
C1123	4030006900	S.CERAMIC C1608 JB 1H 103K-T	T
C1124	4030006900	S.CERAMIC C1608 JB 1H 103K-T	T
C1125	4030006900	S.CERAMIC C1608 JB 1H 103K-T	T

M.-Mounted side (T: Mounted on the Top side, B: Mounted on the Bottom side)

S.-Surface mount

[RXPLL-B UNIT]

REF NO.	ORDER NO.	DESCRIPTION	M.
C1126	4030011600	S.CERAMIC C1608 JB 1E 104K-T	T
C1207	4030006880	S.CERAMIC C1608 JB 1H 472K-T	B
C1231	4030006900	S.CERAMIC C1608 JB 1H 103K-T	T
C1232	4030006900	S.CERAMIC C1608 JB 1H 103K-T	T
C1233	4030006900	S.CERAMIC C1608 JB 1H 103K-T	T
C1234	4030006900	S.CERAMIC C1608 JB 1H 103K-T	B
C1235	4030006880	S.CERAMIC C1608 JB 1H 472K-T	B
C1236	4030006900	S.CERAMIC C1608 JB 1H 103K-T	T
C1237	4030006900	S.CERAMIC C1608 JB 1H 103K-T	T
C1238	4030006900	S.CERAMIC C1608 JB 1H 103K-T	B
C1239	4030006880	S.CERAMIC C1608 JB 1H 472K-T	B
C1240	4030006900	S.CERAMIC C1608 JB 1H 103K-T	T
C1241	4030006900	S.CERAMIC C1608 JB 1H 103K-T	T
C1243	4030006880	S.CERAMIC C1608 JB 1H 472K-T	T
C1244	4030007080	S.CERAMIC C1608 CH 1H 390J-T	T
C1245	4030007130	S.CERAMIC C1608 CH 1H 101J-T	T
C1246	4030007120	S.CERAMIC C1608 CH 1H 820J-T	T
C1247	4030007090	S.CERAMIC C1608 CH 1H 470J-T	T
C1248	4030007130	S.CERAMIC C1608 CH 1H 101J-T	T
C1249	4030007020	S.CERAMIC C1608 CH 1H 120J-T	T
C1250	4030007100	S.CERAMIC C1608 CH 1H 560J-T	B
C1251	4030006900	S.CERAMIC C1608 JB 1H 103K-T	T
C1252	4030006900	S.CERAMIC C1608 JB 1H 103K-T	T
C1253	4030006900	S.CERAMIC C1608 JB 1H 103K-T	B
C1254	4030006900	S.CERAMIC C1608 CH 1H 080D-T	T
C1255	4030006900	S.CERAMIC C1608 JB 1H 103K-T	B
C1264	4030007110	S.CERAMIC C1608 CH 1H 680J-T	T
C1265	4610001160	S.TRIMMER ECR-JA010 A11W	T
C1266	4030007020	S.CERAMIC C1608 CH 1H 120J-T	T
C1267	4030006880	S.CERAMIC C1608 JB 1H 472K-T	B
C1268	4030006980	S.CERAMIC C1608 CH 1H 070D-T	T
C1301	4030006990	S.CERAMIC C1608 CH 1H 080D-T	T
C1302	4030007060	S.CERAMIC C1608 CH 1H 270J-T	T
C1303	4030006980	S.CERAMIC C1608 CH 1H 070D-T	T
C1304	4030007070	S.CERAMIC C1608 CH 1H 330J-T	T
C1305	4030007010	S.CERAMIC C1608 CH 1H 100D-T	T
C1306	4030009650	S.CERAMIC C1608 CH 1H 240J-T	T
C1307	4030007030	S.CERAMIC C1608 CH 1H 150J-T	T
C1308	4030006900	S.CERAMIC C1608 JB 1H 103K-T	B
C1309	4030007080	S.CERAMIC C1608 CH 1H 390J-T	T
C1310	4030007080	S.CERAMIC C1608 CH 1H 390J-T	T
C1311	4030006900	S.CERAMIC C1608 JB 1H 103K-T	B
C1355	4030006880	S.CERAMIC C1608 JB 1H 472K-T	T
C1357	4030007000	S.CERAMIC C1608 CH 1H 090D-T	B
C1358	4030011600	S.CERAMIC C1608 JB 1E 104K-T	B
C1360	4030011600	S.CERAMIC C1608 JB 1E 104K-T	B
C1361	4030007020	S.CERAMIC C1608 CH 1H 120J-T	B
C1362	4030011600	S.CERAMIC C1608 JB 1E 104K-T	T
C1405	4030006900	S.CERAMIC C1608 JB 1H 103K-T	T
C1406	4030017810	S.CERAMIC C1608 CH 1H 102J-T	T
C1407	4030017810	S.CERAMIC C1608 CH 1H 102J-T	T
C1408	4030006900	S.CERAMIC C1608 JB 1H 103K-T	T
C1409	4030006900	S.CERAMIC C1608 JB 1H 103K-T	T
C1410	4030007030	S.CERAMIC C1608 CH 1H 150J-T	T
C1411	4030006990	S.CERAMIC C1608 CH 1H 080D-T	T
C1412	4030007030	S.CERAMIC C1608 CH 1H 150J-T	T
C1413	4030007020	S.CERAMIC C1608 CH 1H 120J-T	T
C1414	4030006990	S.CERAMIC C1608 CH 1H 080D-T	T
C1415	4030007020	S.CERAMIC C1608 CH 1H 120J-T	T
C1416	4030006900	S.CERAMIC C1608 JB 1H 103K-T	T
C1417	4030006900	S.CERAMIC C1608 JB 1H 103K-T	T
C1418	4030017810	S.CERAMIC C1608 CH 1H 102J-T	T
C1419	4030017810	S.CERAMIC C1608 CH 1H 102J-T	T
C1420	4030007120	S.CERAMIC C1608 CH 1H 820J-T	B
C1421	4030007150	S.CERAMIC C1608 CH 1H 151J-T	B
C1423	4030010750	S.CERAMIC C1608 CH 1H 201J-T	T
C1424	4030007010	S.CERAMIC C1608 CH 1H 100D-T	T
C1425	4030011600	S.CERAMIC C1608 JB 1E 104K-T	T
C1426	4030011600	S.CERAMIC C1608 JB 1E 104K-T	T
C1427	4030006900	S.CERAMIC C1608 JB 1H 103K-T	T
C1428	4030006980	S.CERAMIC C1608 CH 1H 070D-T	T
C1429	4030006900	S.CERAMIC C1608 JB 1H 103K-T	T
C1430	4030007040	S.CERAMIC C1608 CH 1H 180J-T	B
C1431	4030017810	S.CERAMIC C1608 CH 1H 102J-T	T
C1432	4030009980	S.CERAMIC C1608 JB 1H 152K-T	T
C1433	4030011600	S.CERAMIC C1608 JB 1E 104K-T	T
C1434	4030009920	S.CERAMIC C1608 CH 1H 050B-T	B
C1435	4030009920	S.CERAMIC C1608 CH 1H 050B-T	B
C1436	4030011600	S.CERAMIC C1608 JB 1E 104K-T	B
C1437	4030009920	S.CERAMIC C1608 CH 1H 050B-T	T
C1438	4030009920	S.CERAMIC C1608 CH 1H 050B-T	T
C1439	4030009920	S.CERAMIC C1608 CH 1H 050B-T	T
C1441	4030006880	S.CERAMIC C1608 JB 1H 472K-T	T
C1501	4030018530	S.CERAMIC C3216 CH 1H 103J-T	T
C1502	4550003220	S.TANTALUM TEESVA 1E 105M8L	T
C1503	4030006900	S.CERAMIC C1608 JB 1H 103K-T	T
C1504	4030012610	S.CERAMIC C2012 JB 1C 474K-T	T
C1505	4030007010	S.CERAMIC C1608 CH 1H 100D-T	T

[RXPLL-B UNIT]

REF NO.	ORDER NO.	DESCRIPTION	M.
C1506	4030010760	S.CERAMIC C1608 CH 1H 331J-T	T
C1507	4510004630	S.ELECTROLYTIC ECEV1CA100SR	T
C1508	4030011600	S.CERAMIC C1608 JB 1E 104K-T	B
C1509	4030018800	S.CERAMIC C3216 CH 1H 223J-T	T
C1510	4030007110	S.CERAMIC C1608 CH 1H 680J-T	T
C1511	4510004630	S.ELECTROLYTIC ECEV1CA100SR	T
C1512	4030011600	S.CERAMIC C1608 JB 1E 104K-T	T
C1513	4030011600	S.CERAMIC C1608 JB 1E 104K-T	T
C1514	4510004630	S.ELECTROLYTIC ECEV1CA100SR	T
C1515	4030007160	S.CERAMIC C1608 CH 1H 181J-T	T
C1516	4030009350	S.CERAMIC C1608 CH 1H 3R5B-T	T
C1517	4030007110	S.CERAMIC C1608 CH 1H 680J-T	T
C1518	4030018530	S.CERAMIC C3216 CH 1H 103J-T	T
C1519	4550003220	S.TANTALUM TEESVA 1E 105M8L	T
C1520	4030006900	S.CERAMIC C1608 JB 1H 103K-T	T
C1521	4030012610	S.CERAMIC C2012 JB 1C 474K-T	T
C1522	4030007010	S.CERAMIC C1608 CH 1H 100D-T	T
C1523	4030010760	S.CERAMIC C1608 CH 1H 331J-T	T
C1524	4030018800	S.CERAMIC C3216 CH 1H 223J-T	T
C1525	4510004630	S.ELECTROLYTIC ECEV1CA100SR	T
C1526	4030011600	S.CERAMIC C1608 JB 1E 104K-T	T
C1527	4030011600	S.CERAMIC C1608 JB 1E 104K-T	T
C1528	4510004630	S.ELECTROLYTIC ECEV1CA100SR	T
C1529	4030017870	S.CERAMIC C1608 CH 1H 681J-T	T
C1530	4030011330	S.CERAMIC C1608 CH 1H 3R9J-T	T
C1531	4510006220	S.ELECTROLYTIC ECEV1CA101UP	T
C1532	4030011600	S.CERAMIC C1608 JB 1E 104K-T	T
C1533	4030011600	S.CERAMIC C1608 JB 1E 104K-T	T
C1534	4510006220	S.ELECTROLYTIC ECEV1CA101UP	T
C1535	4030011600	S.CERAMIC C1608 JB 1E 104K-T	T
C1536	4030017870	S.CERAMIC C1608 CH 1H 681J-T	T
C1537	4510006220	S.ELECTROLYTIC ECEV1CA101UP	T
C1538	4030011600	S.CERAMIC C1608 JB 1E 104K-T	T
C1539	4030011600	S.CERAMIC C1608 JB 1E 104K-T	T
C1540	4510006220	S.ELECTROLYTIC ECEV1CA101UP	T
C1541	4030007050	S.CERAMIC C1608 CH 1H 220J-T	T
C1651	4030006880	S.CERAMIC C1608 JB 1H 472K-T	B
C1653	4030006880	S.CERAMIC C1608 JB 1H 472K-T	B
C1654	4030017810	S.CERAMIC C1608 CH 1H 102J-T	B
C1655	4030009530	S.CERAMIC C1608 CH 1H 030B-T	T
C1656	4610001970	S.TRIMMER TZC3P200A110R00	T
C1657	4030010220	S.CERAMIC C2012 CH 1H 102J-T	T
C1658	4030010220	S.CERAMIC C2012 CH 1H 102J-T	T
C1659	4030011600	S.CERAMIC C1608 JB 1E 104K-T	T
C1660	4030011600	S.CERAMIC C1608 JB 1E 104K-T	B
C1661	4030011600	S.CERAMIC C1608 JB 1E 104K-T	B
C1662	4030011600	S.CERAMIC C1608 JB 1E 104K-T	T
C1663	4030011600	S.CERAMIC C1608 JB 1E 104K-T	T
C1665	4030006900	S.CERAMIC C1608 JB 1H 103K-T	T
C1666	4030006880	S.CERAMIC C1608 JB 1H 472K-T	B
C1701	4030011600	S.CERAMIC C1608 JB 1E 104K-T	T
C1702	4030011600	S.CERAMIC C1608 JB 1E 104K-T	T
C1703	4510004600	ELECTROLYTIC 16 MV 1000 HC	T
C1704	4030011600	S.CERAMIC C1608 JB 1E 104K-T	B
C1705	4030011600	S.CERAMIC C1608 JB 1E 104K-T	B
C1706	4510004640	S.ELECTROLYTIC ECEV1CA470SP	T
C1707	4030011600	S.CERAMIC C1608 JB 1E 104K-T	T
C1708	4030006880	S.CERAMIC C1608 JB 1H 472K-T	T
C1709	4030006880	S.CERAMIC C1608 JB 1H 472K-T	T
C1710	4030006880	S.CERAMIC C1608 JB 1H 472K-T	T
C1711	4030011340	S.CERAMIC C1608 CH 1H 471J-T	T
C1712	4030011340	S.CERAMIC C1608 CH 1H 471J-T	T
C1713	4030006880	S.CERAMIC C1608 JB 1H 472K-T	B
C1714	4030006880	S.CERAMIC C1608 JB 1H 472K-T	B
C1716	4030006880	S.CERAMIC C1608 JB 1H 472K-T	B
C1717	4030006880	S.CERAMIC C1608 JB 1H 472K-T	B
C1719	4030006880	S.CERAMIC C1608 JB 1H 472K-T	B
C1720	4030006880	S.CERAMIC C1608 JB 1H 472K-T	B
C1721	4030006880	S.CERAMIC C1608 JB 1H 472K-T	B
RL1001	6330001750	RELAY FTR-B4CA012Z	T
RL1002	6330001750	RELAY FTR-B4CA012Z	T
RL1003	6330001750	RELAY FTR-B4CA012Z	T
RL1004	6330001750	RELAY FTR-B4CA012Z	T
RL1005	6330001750	RELAY FTR-B4CA012Z	T
RL1006	6330001750	RELAY FTR-B4CA012Z	T
RL1203	6330001750	RELAY FTR-B4CA012Z	T
RL1206	6330001750	RELAY FTR-B4CA012Z	T
J2	6510019990	S.CONNECTOR 52808-2201	T
J10	6510007020	CONNECTOR TMP-J01X-V6	T
J351	6510007020	CONNECTOR TMP-J01X-V6	T
J561	6510007020	CONNECTOR TMP-J01X-V6	T
J601	6510007020	CONNECTOR TMP-J01X-V6	T

M.=Mounted side (T: Mounted on the Top side, B: Mounted on the Bottom side)

S.=Surface mount

[RXPLL-B UNIT]

REF NO.	ORDER NO.	DESCRIPTION		M.
J681	6510007020	CONNECTOR	TMP-J01X-V6	T
J831	6510007020	CONNECTOR	TMP-J01X-V6	T
J1002	6510007020	CONNECTOR	TMP-J01X-V6	T
J1101	6510007020	CONNECTOR	TMP-J01X-V6	T
J1201	6510007020	CONNECTOR	TMP-J01X-V6	T
J1301	6510007020	CONNECTOR	TMP-J01X-V6	T
J1501	6510018960	S.CONNECTOR	B2B-PH-SM3-TB	T
J1701	6510019980	S.CONNECTOR	52808-1691	T
W1052	9016201006	JUMPER	73/98/025/X98/X98	
W1401	9029495075	JUMPER	73/98/020/X98/X98	
W1411	7120000480	S.JUMPER	MJP-0.4-T	T
EP1	0910057634	PCB	B 5990D	
EP20	6910012350	S.BEAD	MMZ1608Y 102BT	T
EP21	6910012350	S.BEAD	MMZ1608Y 102BT	T
EP22	6910012350	S.BEAD	MMZ1608Y 102BT	T
EP101	6910012350	S.BEAD	MMZ1608Y 102BT	B
EP102	6910012350	S.BEAD	MMZ1608Y 102BT	B
EP103	6910012350	S.BEAD	MMZ1608Y 102BT	T
EP104	6910012350	S.BEAD	MMZ1608Y 102BT	T
EP105	6910012350	S.BEAD	MMZ1608Y 102BT	T
EP106	6910012350	S.BEAD	MMZ1608Y 102BT	T
EP107	6910012350	S.BEAD	MMZ1608Y 102BT	B
EP1701	6910012350	S.BEAD	MMZ1608Y 102BT	T
EP1702	6910012350	S.BEAD	MMZ1608Y 102BT	T
EP1801	6910012350	S.BEAD	MMZ1608Y 102BT	B
EP1802	6910012350	S.BEAD	MMZ1608Y 102BT	B
EP1804	6910012350	S.BEAD	MMZ1608Y 102BT	B
EP1805	6910012350	S.BEAD	MMZ1608Y 102BT	B
EP1806	6910012350	S.BEAD	MMZ1608Y 102BT	B
EP1807	6910012350	S.BEAD	MMZ1608Y 102BT	B
EP1808	6910012350	S.BEAD	MMZ1608Y 102BT	B
EP1809	6910012350	S.BEAD	MMZ1608Y 102BT	B
EP1810	6910012350	S.BEAD	MMZ1608Y 102BT	B
EP1811	6910012350	S.BEAD	MMZ1608Y 102BT	B
EP1812	6910012350	S.BEAD	MMZ1608Y 102BT	B
EP1813	6910012350	S.BEAD	MMZ1608Y 102BT	B
EP1814	6910012350	S.BEAD	MMZ1608Y 102BT	B
EP1815	6910012350	S.BEAD	MMZ1608Y 102BT	B
EP1816	6910012350	S.BEAD	MMZ1608Y 102BT	B
EP1817	6910012350	S.BEAD	MMZ1608Y 102BT	B
EP1818	6910012350	S.BEAD	MMZ1608Y 102BT	B
EP1819	6910012350	S.BEAD	MMZ1608Y 102BT	B
EP1820	6910012350	S.BEAD	MMZ1608Y 102BT	B
EP1821	6910012350	S.BEAD	MMZ1608Y 102BT	B
EP1825	6910012350	S.BEAD	MMZ1608Y 102BT	B
EP1826	6910012350	S.BEAD	MMZ1608Y 102BT	B
EP1830	6910012350	S.BEAD	MMZ1608Y 102BT	B
EP1831	6910012350	S.BEAD	MMZ1608Y 102BT	B
EP1832	6910012350	S.BEAD	MMZ1608Y 102BT	B
EP1833	6910012350	S.BEAD	MMZ1608Y 102BT	B
EP1834	6910012350	S.BEAD	MMZ1608Y 102BT	T
EP1835	6910012350	S.BEAD	MMZ1608Y 102BT	B
EP1836	6910012350	S.BEAD	MMZ1608Y 102BT	T

[BPF UNIT]

REF NO.	ORDER NO.	DESCRIPTION		M.
Q873	1530002840	S.TRANSISTOR	2SC4116-Y (TE85R)	B
Q874	1590000430	S.TRANSISTOR	DTC144EUA T106	T
Q900	1590001330	S.TRANSISTOR	DTA114EUA T106	B
Q901	1530003850	S.TRANSISTOR	2SC5551F-TD	T
Q902	1590001330	S.TRANSISTOR	DTA114EUA T106	T
Q903	1530003850	S.TRANSISTOR	2SC5551F-TD	T
Q950	1590001330	S.TRANSISTOR	DTA114EUA T106	B
Q951	1530003850	S.TRANSISTOR	2SC5551F-TD	T
Q952	1590001330	S.TRANSISTOR	DTA114EUA T106	B
Q953	1530003850	S.TRANSISTOR	2SC5551F-TD	T
D1	1790001250	S.DIODE	MA2S111-(TX)	T
D21	1790001250	S.DIODE	MA2S111-(TX)	B
D51	1790001250	S.DIODE	MA2S111-(TX)	T
D81	1790001250	S.DIODE	MA2S111-(TX)	B
D111	1790001250	S.DIODE	MA2S111-(TX)	T
D141	1790001250	S.DIODE	MA2S111-(TX)	T
D171	1790001250	S.DIODE	MA2S111-(TX)	B
D201	1790001250	S.DIODE	MA2S111-(TX)	B
D231	1790001250	S.DIODE	MA2S111-(TX)	T
D261	1790001250	S.DIODE	MA2S111-(TX)	B
D291	1790001250	S.DIODE	MA2S111-(TX)	B
D321	1790001250	S.DIODE	MA2S111-(TX)	T
D351	1790001250	S.DIODE	MA2S111-(TX)	T
D352	1790001250	S.DIODE	MA2S111-(TX)	T
D353	1790001250	S.DIODE	MA2S111-(TX)	T
D354	1790001250	S.DIODE	MA2S111-(TX)	T
D355	1790001250	S.DIODE	MA2S111-(TX)	T
D371	1790001250	S.DIODE	MA2S111-(TX)	T
D373	1790001250	S.DIODE	MA2S111-(TX)	B
D391	1790000620	S.DIODE	MA77 (TX)	B
D392	1790000620	S.DIODE	MA77 (TX)	B
D393	1750000850	S.DIODE	MMBV3700LT1	B
D401	1790001250	S.DIODE	MA2S111-(TX)	B
D402	1790000980	S.DIODE	MA742 (TX)	B
D501	1790001250	S.DIODE	MA2S111-(TX)	B
D531	1790001250	S.DIODE	MA2S111-(TX)	B
D561	1790001250	S.DIODE	MA2S111-(TX)	B
D591	1790001250	S.DIODE	MA2S111-(TX)	B
D621	1790001250	S.DIODE	MA2S111-(TX)	T
D651	1790001250	S.DIODE	MA2S111-(TX)	B
D681	1790001250	S.DIODE	MA2S111-(TX)	B
D711	1790001250	S.DIODE	MA2S111-(TX)	B
D741	1790001250	S.DIODE	MA2S111-(TX)	B
D771	1790001250	S.DIODE	MA2S111-(TX)	B
D801	1790001250	S.DIODE	MA2S111-(TX)	B
D831	1790001250	S.DIODE	MA2S111-(TX)	T
D851	1790001250	S.DIODE	MA2S111-(TX)	T
D852	1790001250	S.DIODE	MA2S111-(TX)	T
D853	1790001250	S.DIODE	MA2S111-(TX)	T
D854	1790001250	S.DIODE	MA2S111-(TX)	T
D855	1790001250	S.DIODE	MA2S111-(TX)	T
D871	1790001250	S.DIODE	MA2S111-(TX)	B
D872	1790000980	S.DIODE	MA742 (TX)	B
D873	1790001250	S.DIODE	MA2S111-(TX)	B
D900	1790001250	S.DIODE	MA2S111-(TX)	B
D901	1790001250	S.DIODE	MA2S111-(TX)	T
D902	1790001250	S.DIODE	MA2S111-(TX)	B
D903	1790001250	S.DIODE	MA2S111-(TX)	B
D950	1790001250	S.DIODE	MA2S111-(TX)	B
D951	1790001250	S.DIODE	MA2S111-(TX)	B
D952	1790001250	S.DIODE	MA2S111-(TX)	B
D953	1790001250	S.DIODE	MA2S111-(TX)	B
D954	1790001250	S.DIODE	MA2S111-(TX)	T
L1	6200005520	S.COIL	NL 252018T-470J	T
L2	6200005520	S.COIL	NL 252018T-470J	B
L3	6200010830	S.COIL	C2520C-3R3G-A	T
L4	6200010830	S.COIL	C2520C-3R3G-A	T
L5	6200010830	S.COIL	C2520C-3R3G-A	T
L6	6200010830	S.COIL	C2520C-3R3G-A	T
L21	6200005520	S.COIL	NL 252018T-470J	B
L22	6200005520	S.COIL	NL 252018T-470J	B
L23	6140004040	COIL	LR-443	T
L24	6140004050	COIL	LR-444	T
L25	6140004050	COIL	LR-444	T
L26	6140004050	COIL	LR-444	T
L27	6140004040	COIL	LR-443	T
L51	6200005520	S.COIL	NL 252018T-470J	B
L52	6200005520	S.COIL	NL 252018T-470J	B
L53	6140004060	COIL	LR-445	T
L54	6140004080	COIL	LR-446	T
L55	6140004080	COIL	LR-446	T
L56	6140004080	COIL	LR-446	T
L57	6140004060	COIL	LR-445	T
L81	6200005520	S.COIL	NL 252018T-470J	B

[BPF UNIT]

REF NO.	ORDER NO.	DESCRIPTION		M.
IC101	1130011510	S.IC	BU2099FV-E2	T
IC102	1130011510	S.IC	BU2099FV-E2	T
IC401	1130011510	S.IC	BU2099FV-E2	T
IC402	1130011510	S.IC	BU2099FV-E2	T
Q355	1590001330	S.TRANSISTOR	DTA114EUA T106	T
Q381	1590000430	S.TRANSISTOR	DTC144EUA T106	T
Q383	1590000430	S.TRANSISTOR	DTC144EUA T106	T
Q384	1590000430	S.TRANSISTOR	DTC144EUA T106	T
Q385	1590000430	S.TRANSISTOR	DTC144EUA T106	T
Q386	1590000430	S.TRANSISTOR	DTC144EUA T106	T
Q387	1590000430	S.TRANSISTOR	DTC144EUA T106	T
Q401	1530002840	S.TRANSISTOR	2SC4116-Y (TE85R)	T
Q402	1530002060	S.TRANSISTOR	2SC4081 T106 R	B
Q403	1590001330	S.TRANSISTOR	DTA114EUA T106	B
Q404	1590000430	S.TRANSISTOR	DTC144EUA T106	B
Q855	1590001330	S.TRANSISTOR	DTA114EUA T106	T
Q871	1590001330	S.TRANSISTOR	DTA114EUA T106	B
Q872	1530002060	S.TRANSISTOR	2SC4081 T106 R	B

M.-Mounted side (T: Mounted on the Top side, B: Mounted on the Bottom side)

S.-Surface mount

[BPF UNIT]

REF NO.	ORDER NO.	DESCRIPTION		M.
L82	6200005520	S.COIL	NL 252018T-470J	B
L83	6140004090	COIL	LR-447	T
L84	6140004230	COIL	LR-458	T
L85	6140004230	COIL	LR-458	T
L86	6140004230	COIL	LR-458	T
L87	6140004090	COIL	LR-447	T
L111	6200005520	S.COIL	NL 252018T-470J	B
L112	6200005520	S.COIL	NL 252018T-470J	B
L113	6140004090	COIL	LR-447	T
L114	6140004100	COIL	LR-448	T
L115	6140004100	COIL	LR-448	T
L116	6140004100	COIL	LR-448	T
L117	6140004090	COIL	LR-447	T
L141	6200005520	S.COIL	NL 252018T-470J	B
L142	6200005520	S.COIL	NL 252018T-470J	B
L143	6140004110	COIL	LR-449	T
L144	6140004120	COIL	LR-450	T
L145	6140004120	COIL	LR-450	T
L146	6140004120	COIL	LR-450	T
L147	6140004110	COIL	LR-449	T
L171	6200005520	S.COIL	NL 252018T-470J	B
L172	6200005520	S.COIL	NL 252018T-470J	B
L173	6140004140	COIL	LR-451	T
L174	6140004150	COIL	LR-452	T
L175	6140004150	COIL	LR-452	T
L176	6140004150	COIL	LR-452	T
L177	6140004140	COIL	LR-451	T
L201	6200007020	S.COIL	NL 252018T-270J	B
L202	6200007020	S.COIL	NL 252018T-270J	B
L203	6140004160	COIL	LR-453	T
L204	6140004180	COIL	LR-454	T
L205	6140004180	COIL	LR-454	T
L206	6140004180	COIL	LR-454	T
L207	6140004160	COIL	LR-453	T
L231	6200005010	S.COIL	NL 252018T-100J	B
L232	6200005010	S.COIL	NL 252018T-100J	B
L233	6140004190	COIL	LR-455	T
L234	6140004210	COIL	LR-456	T
L235	6140004210	COIL	LR-456	T
L236	6140004210	COIL	LR-456	T
L237	6140004190	COIL	LR-455	T
L261	6200009140	S.COIL	NL 252018T-6R8J	B
L262	6200009140	S.COIL	NL 252018T-6R8J	B
L263	6140004220	COIL	LR-457	T
L264	6140004160	COIL	LR-453	T
L265	6140004160	COIL	LR-453	T
L266	6140004160	COIL	LR-453	T
L267	6140004220	COIL	LR-457	T
L291	6200003280	S.COIL	NL 252018T-2R2J	B
L292	6200003280	S.COIL	NL 252018T-2R2J	B
L293	6200008090	S.COIL	LQW2BHN68NJ01L (LQN21A 68NJ04)	T
L294	6200003040	S.COIL	NL 322522T-R68J-3	T
L295	6200008090	S.COIL	LQW2BHN68NJ01L (LQN21A 68NJ04)	T
L296	6200010870	S.COIL	C2520C-R33G (0.33U)	T
L321	6200003280	S.COIL	NL 252018T-2R2J	B
L322	6200003280	S.COIL	NL 252018T-2R2J	B
L323	6200003010	S.COIL	NL 322522T-R27J-3	T
L324	6200003000	S.COIL	NL 322522T-R22J-3	T
L325	6200003010	S.COIL	NL 322522T-R27J-3	T
L371	6140004390	COIL	LR-459	T
L372	6140004390	COIL	LR-459	T
L373	6140003530	COIL	LR-395	T
L391	6200005490	S.COIL	NL 322522T-331J	T
L392	6200005490	S.COIL	NL 322522T-331J	T
L501	6200005520	S.COIL	NL 252018T-470J	B
L502	6200005520	S.COIL	NL 252018T-470J	B
L504	6200010830	S.COIL	C2520C-3R3G-A	T
L505	6200010830	S.COIL	C2520C-3R3G-A	T
L506	6200010830	S.COIL	C2520C-3R3G-A	T
L507	6200010830	S.COIL	C2520C-3R3G-A	T
L531	6200005520	S.COIL	NL 252018T-470J	B
L532	6200005520	S.COIL	NL 252018T-470J	B
L533	6140004040	COIL	LR-443	T
L534	6140004050	COIL	LR-444	T
L535	6140004050	COIL	LR-444	T
L536	6140004050	COIL	LR-444	T
L537	6140004040	COIL	LR-443	T
L561	6200005520	S.COIL	NL 252018T-470J	B
L562	6200005520	S.COIL	NL 252018T-470J	B
L563	6140004060	COIL	LR-445	T
L564	6140004080	COIL	LR-446	T
L565	6140004080	COIL	LR-446	T
L566	6140004080	COIL	LR-446	T
L567	6140004060	COIL	LR-445	T
L591	6200005520	S.COIL	NL 252018T-470J	B
L592	6200005520	S.COIL	NL 252018T-470J	B
L593	6140004090	COIL	LR-447	T
L594	6140004230	COIL	LR-458	T

M.=Mounted side (T: Mounted on the Top side, B: Mounted on the Bottom side)

[BPF UNIT]

REF NO.	ORDER NO.	DESCRIPTION		M.
L595	6140004230	COIL	LR-458	T
L596	6140004230	COIL	LR-458	T
L597	6140004090	COIL	LR-447	T
L621	6200005520	S.COIL	NL 252018T-470J	B
L622	6200005520	S.COIL	NL 252018T-470J	B
L623	6140004090	COIL	LR-447	T
L624	6140004100	COIL	LR-448	T
L625	6140004100	COIL	LR-448	T
L626	6140004100	COIL	LR-448	T
L627	6140004090	COIL	LR-447	T
L651	6200005520	S.COIL	NL 252018T-470J	B
L652	6200005520	S.COIL	NL 252018T-470J	B
L653	6140004110	COIL	LR-449	T
L654	6140004120	COIL	LR-450	T
L655	6140004120	COIL	LR-450	T
L656	6140004120	COIL	LR-450	T
L657	6140004110	COIL	LR-449	T
L681	6200005520	S.COIL	NL 252018T-470J	B
L682	6200005520	S.COIL	NL 252018T-470J	B
L683	6140004140	COIL	LR-451	T
L684	6140004150	COIL	LR-452	T
L685	6140004150	COIL	LR-452	T
L686	6140004150	COIL	LR-452	T
L687	6140004140	COIL	LR-451	T
L711	6200007020	S.COIL	NL 252018T-270J	B
L712	6200007020	S.COIL	NL 252018T-270J	B
L713	6140004160	COIL	LR-453	T
L714	6140004180	COIL	LR-454	T
L715	6140004180	COIL	LR-454	T
L716	6140004180	COIL	LR-454	T
L717	6140004160	COIL	LR-453	T
L741	6200005010	S.COIL	NL 252018T-100J	B
L742	6200005010	S.COIL	NL 252018T-100J	B
L743	6140004190	COIL	LR-455	T
L744	6140004210	COIL	LR-456	T
L745	6140004210	COIL	LR-456	T
L746	6140004210	COIL	LR-456	T
L747	6140004190	COIL	LR-455	T
L771	6200009140	S.COIL	NL 252018T-6R8J	B
L772	6200009140	S.COIL	NL 252018T-6R8J	B
L773	6140004220	COIL	LR-457	T
L774	6140004160	COIL	LR-453	T
L775	6140004160	COIL	LR-453	T
L776	6140004160	COIL	LR-453	T
L777	6140004220	COIL	LR-457	T
L801	6200003280	S.COIL	NL 252018T-2R2J	B
L802	6200003280	S.COIL	NL 252018T-2R2J	B
L805	6200008090	S.COIL	LQW2BHN68NJ01L (LQN21A 68NJ04)	T
L806	6200003040	S.COIL	NL 322522T-R68J-3	T
L807	6200008090	S.COIL	LQW2BHN68NJ01L (LQN21A 68NJ04)	T
L808	6200010870	S.COIL	C2520C-R33G (0.33U)	T
L831	6200003280	S.COIL	NL 252018T-2R2J	B
L832	6200003280	S.COIL	NL 252018T-2R2J	B
L833	6200003010	S.COIL	NL 322522T-R27J-3	T
L834	6200003000	S.COIL	NL 322522T-R22J-3	T
L835	6200003010	S.COIL	NL 322522T-R27J-3	T
L900	6200001830	S.COIL	NL 322522T-100J	B
L901	6200003950	S.COIL	HF50ACC 322513-T	B
L902	6200003950	S.COIL	HF50ACC 322513-T	B
L903	6200001830	S.COIL	NL 322522T-100J	T
L904	6200001830	S.COIL	NL 322522T-100J	T
L905	6140004380	COIL	LR-498	T
L906	6200009690	S.COIL	LQH43CN101K01L (LQH 4C 101K04)	T
L907	6200001830	S.COIL	NL 322522T-100J	B
L908	6140004380	COIL	LR-498	T
L909	6200009690	S.COIL	LQH43CN101K01L (LQH 4C 101K04)	T
L950	6200001830	S.COIL	NL 322522T-100J	B
L951	6140004380	COIL	LR-498	T
L952	6200009690	S.COIL	LQH43CN101K01L (LQH 4C 101K04)	T
L953	6200001830	S.COIL	NL 322522T-100J	B
L954	6140004380	COIL	LR-498	T
L955	6200009690	S.COIL	LQH43CN101K01L (LQH 4C 101K04)	T
R1	7030003640	S.RESISTOR	ERJ3GEYJ 473 V (47 kΩ)	T
R3	7030003860	S.RESISTOR	ERJ3GE JPW V	T
R101	7030003320	S.RESISTOR	ERJ3GEYJ 101 V (100 Ω)	T
R102	7030003320	S.RESISTOR	ERJ3GEYJ 101 V (100 Ω)	T
R103	7030003320	S.RESISTOR	ERJ3GEYJ 101 V (100 Ω)	T
R104	7030003320	S.RESISTOR	ERJ3GEYJ 101 V (100 Ω)	T
R105	7030003320	S.RESISTOR	ERJ3GEYJ 101 V (100 Ω)	T
R106	7030003320	S.RESISTOR	ERJ3GEYJ 101 V (100 Ω)	T
R107	7030003320	S.RESISTOR	ERJ3GEYJ 101 V (100 Ω)	T
R108	7030003320	S.RESISTOR	ERJ3GEYJ 101 V (100 Ω)	T
R117	7030003320	S.RESISTOR	ERJ3GEYJ 101 V (100 Ω)	T
R118	7030003320	S.RESISTOR	ERJ3GEYJ 101 V (100 Ω)	T
R119	7030003320	S.RESISTOR	ERJ3GEYJ 101 V (100 Ω)	T
R120	7030003320	S.RESISTOR	ERJ3GEYJ 101 V (100 Ω)	T

S.=Surface mount

[BPF UNIT]

REF NO.	ORDER NO.	DESCRIPTION	M.
R121	7030003320	S.RESISTOR ERJ3GEYJ 101 V (100 Ω)	T
R122	7030003320	S.RESISTOR ERJ3GEYJ 101 V (100 Ω)	T
R123	7030003320	S.RESISTOR ERJ3GEYJ 101 V (100 Ω)	B
R124	7030003320	S.RESISTOR ERJ3GEYJ 101 V (100 Ω)	T
R133	7030003560	S.RESISTOR ERJ3GEYJ 103 V (10 kΩ)	T
R134	7030003320	S.RESISTOR ERJ3GEYJ 101 V (100 Ω)	B
R141	7030003360	S.RESISTOR ERJ3GEYJ 221 V (220 Ω)	B
R142	7030003360	S.RESISTOR ERJ3GEYJ 221 V (220 Ω)	B
R143	7030003360	S.RESISTOR ERJ3GEYJ 221 V (220 Ω)	B
R351	7030003340	S.RESISTOR ERJ3GEYJ 151 V (150 Ω)	B
R352	7030003300	S.RESISTOR ERJ3GEYJ 680 V (68 Ω)	B
R354	7030003280	S.RESISTOR ERJ3GEYJ 470 V (47 Ω)	B
R355	7030003320	S.RESISTOR ERJ3GEYJ 101 V (100 Ω)	B
R357	7030003240	S.RESISTOR ERJ3GEYJ 220 V (22 Ω)	B
R358	7030003350	S.RESISTOR ERJ3GEYJ 181 V (180 Ω)	B
R360	7030003320	S.RESISTOR ERJ3GEYJ 101 V (100 Ω)	T
R371	7030003320	S.RESISTOR ERJ3GEYJ 101 V (100 Ω)	T
R372	7030003320	S.RESISTOR ERJ3GEYJ 101 V (100 Ω)	B
R373	7030003320	S.RESISTOR ERJ3GEYJ 101 V (100 Ω)	B
R381	7030003560	S.RESISTOR ERJ3GEYJ 103 V (10 kΩ)	T
R382	7030003360	S.RESISTOR ERJ3GEYJ 221 V (220 Ω)	T
R383	7030003680	S.RESISTOR ERJ3GEYJ 104 V (100 kΩ)	B
R384	7030003480	S.RESISTOR ERJ3GEYJ 222 V (2.2 kΩ)	B
R385	7030003380	S.RESISTOR ERJ3GEYJ 331 V (330 Ω)	B
R386	7030003520	S.RESISTOR ERJ3GEYJ 472 V (4.7 kΩ)	B
R387	7030003560	S.RESISTOR ERJ3GEYJ 103 V (10 kΩ)	T
R388	7540000130	ABSORBER 2P-50A-301	T
R389	7030003380	S.RESISTOR ERJ3GEYJ 331 V (330 Ω)	T
R390	7030003560	S.RESISTOR ERJ3GEYJ 103 V (10 kΩ)	T
R391	7030003680	S.RESISTOR ERJ3GEYJ 104 V (100 kΩ)	T
R401	7030003360	S.RESISTOR ERJ3GEYJ 221 V (220 Ω)	B
R402	7030003680	S.RESISTOR ERJ3GEYJ 104 V (100 kΩ)	T
R403	7030003480	S.RESISTOR ERJ3GEYJ 222 V (2.2 kΩ)	T
R404	7030003860	S.RESISTOR ERJ3GE JPW V	T
R441	7030003360	S.RESISTOR ERJ3GEYJ 221 V (220 Ω)	B
R442	7030003360	S.RESISTOR ERJ3GEYJ 221 V (220 Ω)	B
R451	7030003320	S.RESISTOR ERJ3GEYJ 101 V (100 Ω)	T
R452	7030003320	S.RESISTOR ERJ3GEYJ 101 V (100 Ω)	T
R453	7030003320	S.RESISTOR ERJ3GEYJ 101 V (100 Ω)	T
R454	7030003320	S.RESISTOR ERJ3GEYJ 101 V (100 Ω)	T
R455	7030003320	S.RESISTOR ERJ3GEYJ 101 V (100 Ω)	T
R456	7030003320	S.RESISTOR ERJ3GEYJ 101 V (100 Ω)	T
R457	7030003320	S.RESISTOR ERJ3GEYJ 101 V (100 Ω)	T
R458	7030003320	S.RESISTOR ERJ3GEYJ 101 V (100 Ω)	T
R467	7030003320	S.RESISTOR ERJ3GEYJ 101 V (100 Ω)	T
R468	7030003320	S.RESISTOR ERJ3GEYJ 101 V (100 Ω)	T
R469	7030003320	S.RESISTOR ERJ3GEYJ 101 V (100 Ω)	T
R470	7030003320	S.RESISTOR ERJ3GEYJ 101 V (100 Ω)	T
R471	7030003320	S.RESISTOR ERJ3GEYJ 101 V (100 Ω)	T
R472	7030003320	S.RESISTOR ERJ3GEYJ 101 V (100 Ω)	T
R473	7030003320	S.RESISTOR ERJ3GEYJ 101 V (100 Ω)	T
R474	7030003320	S.RESISTOR ERJ3GEYJ 101 V (100 Ω)	T
R475	7030003320	S.RESISTOR ERJ3GEYJ 101 V (100 Ω)	T
R481	7030003560	S.RESISTOR ERJ3GEYJ 103 V (10 kΩ)	B
R501	7030003640	S.RESISTOR ERJ3GEYJ 473 V (47 kΩ)	T
R503	7030003860	S.RESISTOR ERJ3GE JPW V	T
R851	7030003340	S.RESISTOR ERJ3GEYJ 151 V (150 Ω)	B
R852	7030003300	S.RESISTOR ERJ3GEYJ 680 V (68 Ω)	B
R854	7030003280	S.RESISTOR ERJ3GEYJ 470 V (47 Ω)	B
R855	7030003320	S.RESISTOR ERJ3GEYJ 101 V (100 Ω)	B
R857	7030003240	S.RESISTOR ERJ3GEYJ 220 V (22 Ω)	B
R858	7030003350	S.RESISTOR ERJ3GEYJ 181 V (180 Ω)	B
R860	7030003320	S.RESISTOR ERJ3GEYJ 101 V (100 Ω)	T
R871	7030003360	S.RESISTOR ERJ3GEYJ 221 V (220 Ω)	B
R872	7030003680	S.RESISTOR ERJ3GEYJ 104 V (100 kΩ)	B
R873	7030003480	S.RESISTOR ERJ3GEYJ 222 V (2.2 kΩ)	B
R874	7030003860	S.RESISTOR ERJ3GE JPW V	B
R900	7030003280	S.RESISTOR ERJ3GEYJ 470 V (47 Ω)	B
R901	7030003440	S.RESISTOR ERJ3GEYJ 102 V (1 kΩ)	T
R902	7030003530	S.RESISTOR ERJ3GEYJ 562 V (5.6 kΩ)	T
R903	7030003380	S.RESISTOR ERJ3GEYJ 331 V (330 Ω)	B
R904	7030003220	S.RESISTOR ERJ3GEYJ 150 V (15 Ω)	B
R905	7030003380	S.RESISTOR ERJ3GEYJ 331 V (330 Ω)	B
R906	7030003320	S.RESISTOR ERJ3GEYJ 101 V (100 Ω)	T
R907	7030003320	S.RESISTOR ERJ3GEYJ 101 V (100 Ω)	T
R908	7030003280	S.RESISTOR ERJ3GEYJ 470 V (47 Ω)	B
R909	7030003440	S.RESISTOR ERJ3GEYJ 102 V (1 kΩ)	T
R910	7030003530	S.RESISTOR ERJ3GEYJ 562 V (5.6 kΩ)	T
R911	7030003320	S.RESISTOR ERJ3GEYJ 101 V (100 Ω)	B
R912	7030003320	S.RESISTOR ERJ3GEYJ 101 V (100 Ω)	B
R913	7030004050	S.RESISTOR ERJ3GEYJ 1R0 V (1 Ω)	B
R950	7030003280	S.RESISTOR ERJ3GEYJ 470 V (47 Ω)	B
R951	7030003440	S.RESISTOR ERJ3GEYJ 102 V (1 kΩ)	T
R952	7030003530	S.RESISTOR ERJ3GEYJ 562 V (5.6 kΩ)	T
R953	7030003380	S.RESISTOR ERJ3GEYJ 331 V (330 Ω)	B
R954	7030003220	S.RESISTOR ERJ3GEYJ 150 V (15 Ω)	B
R955	7030003380	S.RESISTOR ERJ3GEYJ 331 V (330 Ω)	B
R956	7030003320	S.RESISTOR ERJ3GEYJ 101 V (100 Ω)	T

[BPF UNIT]

REF NO.	ORDER NO.	DESCRIPTION	M.
R957	7030003320	S.RESISTOR ERJ3GEYJ 101 V (100 Ω)	B
R958	7030003280	S.RESISTOR ERJ3GEYJ 470 V (47 Ω)	B
R959	7030003440	S.RESISTOR ERJ3GEYJ 102 V (1 kΩ)	T
R960	7030003530	S.RESISTOR ERJ3GEYJ 562 V (5.6 kΩ)	T
R961	7030003320	S.RESISTOR ERJ3GEYJ 101 V (100 Ω)	B
R962	7030003320	S.RESISTOR ERJ3GEYJ 101 V (100 Ω)	B
R963	7030004050	S.RESISTOR ERJ3GEYJ 1R0 V (1 Ω)	B
C1	4030006880	S.CERAMIC C1608 JB 1H 472K-T	B
C2	4030006880	S.CERAMIC C1608 JB 1H 472K-T	T
C3	4030006880	S.CERAMIC C1608 JB 1H 472K-T	T
C4	4030006880	S.CERAMIC C1608 JB 1H 472K-T	B
C5	4030006880	S.CERAMIC C1608 JB 1H 472K-T	B
C6	4030006880	S.CERAMIC C1608 JB 1H 472K-T	T
C7	4030017840	S.CERAMIC C2012 CH 1H 222J-T	T
C8	4030017850	S.CERAMIC C2012 CH 1H 272J-T	T
C9	4030017820	S.CERAMIC C2012 CH 1H 122J-T	T
C10	4030017840	S.CERAMIC C2012 CH 1H 222J-T	T
C21	4030006880	S.CERAMIC C1608 JB 1H 472K-T	B
C22	4030006880	S.CERAMIC C1608 JB 1H 472K-T	B
C23	4030006880	S.CERAMIC C1608 JB 1H 472K-T	B
C24	4030006880	S.CERAMIC C1608 JB 1H 472K-T	T
C25	4030006880	S.CERAMIC C1608 JB 1H 472K-T	B
C26	4030006880	S.CERAMIC C1608 JB 1H 472K-T	B
C27	4030017810	S.CERAMIC C1608 CH 1H 102J-T	B
C28	4030017810	S.CERAMIC C1608 CH 1H 102J-T	B
C29	4030010760	S.CERAMIC C1608 CH 1H 331J-T	B
C30	4030007140	S.CERAMIC C1608 CH 1H 121J-T	B
C31	4030007160	S.CERAMIC C1608 CH 1H 181J-T	B
C32	4030007060	S.CERAMIC C1608 CH 1H 270J-T	B
C33	4030010760	S.CERAMIC C1608 CH 1H 331J-T	B
C34	4030007090	S.CERAMIC C1608 CH 1H 470J-T	B
C35	4030007160	S.CERAMIC C1608 CH 1H 181J-T	B
C36	4030007060	S.CERAMIC C1608 CH 1H 270J-T	B
C38	4030010760	S.CERAMIC C1608 CH 1H 331J-T	B
C39	4030007140	S.CERAMIC C1608 CH 1H 121J-T	B
C40	4030017810	S.CERAMIC C1608 CH 1H 102J-T	B
C41	4030017810	S.CERAMIC C1608 CH 1H 102J-T	B
C51	4030006880	S.CERAMIC C1608 JB 1H 472K-T	T
C52	4030006880	S.CERAMIC C1608 JB 1H 472K-T	B
C53	4030006880	S.CERAMIC C1608 JB 1H 472K-T	B
C54	4030006880	S.CERAMIC C1608 JB 1H 472K-T	B
C55	4030006880	S.CERAMIC C1608 JB 1H 472K-T	B
C56	4030006880	S.CERAMIC C1608 JB 1H 472K-T	T
C57	4030017800	S.CERAMIC C1608 CH 1H 561J-T	B
C58	4030010760	S.CERAMIC C1608 CH 1H 331J-T	B
C59	4030010760	S.CERAMIC C1608 CH 1H 331J-T	B
C60	4030007080	S.CERAMIC C1608 CH 1H 390J-T	B
C61	4030007100	S.CERAMIC C1608 CH 1H 560J-T	B
C62	4030010760	S.CERAMIC C1608 CH 1H 331J-T	B
C63	4030010760	S.CERAMIC C1608 CH 1H 331J-T	B
C64	4030007090	S.CERAMIC C1608 CH 1H 470J-T	B
C65	4030010760	S.CERAMIC C1608 CH 1H 331J-T	B
C66	4030007100	S.CERAMIC C1608 CH 1H 560J-T	B
C67	4030010760	S.CERAMIC C1608 CH 1H 331J-T	B
C68	4030007080	S.CERAMIC C1608 CH 1H 390J-T	B
C69	4030017800	S.CERAMIC C1608 CH 1H 561J-T	B
C70	4030010760	S.CERAMIC C1608 CH 1H 331J-T	B
C81	4030006880	S.CERAMIC C1608 JB 1H 472K-T	B
C82	4030006880	S.CERAMIC C1608 JB 1H 472K-T	B
C83	4030006880	S.CERAMIC C1608 JB 1H 472K-T	B
C84	4030006880	S.CERAMIC C1608 JB 1H 472K-T	B
C85	4030006880	S.CERAMIC C1608 JB 1H 472K-T	B
C86	4030006880	S.CERAMIC C1608 JB 1H 472K-T	B
C87	4030017800	S.CERAMIC C1608 CH 1H 561J-T	B
C88	4030011330	S.CERAMIC C1608 CH 1H 391J-T	B
C89	4030007160	S.CERAMIC C1608 CH 1H 181J-T	B
C90	4030007070	S.CERAMIC C1608 CH 1H 330J-T	B
C91	4030007030	S.CERAMIC C1608 CH 1H 150J-T	B
C92	4030007120	S.CERAMIC C1608 CH 1H 820J-T	B
C93	4030007140	S.CERAMIC C1608 CH 1H 121J-T	B
C94	4030007100	S.CERAMIC C1608 CH 1H 560J-T	B
C95	4030007120	S.CERAMIC C1608 CH 1H 820J-T	B
C96	4030007030	S.CERAMIC C1608 CH 1H 150J-T	B
C97	4030007160	S.CERAMIC C1608 CH 1H 181J-T	B
C98	4030007070	S.CERAMIC C1608 CH 1H 330J-T	B
C99	4030017800	S.CERAMIC C1608 CH 1H 561J-T	B
C100	4030011330	S.CERAMIC C1608 CH 1H 391J-T	B
C111	4030006880	S.CERAMIC C1608 JB 1H 472K-T	B
C112	4030006880	S.CERAMIC C1608 JB 1H 472K-T	B
C113	4030006880	S.CERAMIC C1608 JB 1H 472K-T	B
C114	4030006880	S.CERAMIC C1608 JB 1H 472K-T	B
C115	4030006880	S.CERAMIC C1608 JB 1H 472K-T	B
C116	4030006880	S.CERAMIC C1608 JB 1H 472K-T	T
C117	4030010760	S.CERAMIC C1608 CH 1H 331J-T	B
C118	4030007150	S.CERAMIC C1608 CH 1H 151J-T	B
C119	4030007150	S.CERAMIC C1608 CH 1H 151J-T	B

M.—Mounted side (T: Mounted on the Top side, B: Mounted on the Bottom side)

S.—Surface mount

[BPF UNIT]

REF NO.	ORDER NO.	DESCRIPTION	M.
C831	4030006880	S.CERAMIC C1608 JB 1H 472K-T	T
C832	4030006880	S.CERAMIC C1608 JB 1H 472K-T	B
C833	4030006880	S.CERAMIC C1608 JB 1H 472K-T	T
C834	4030006880	S.CERAMIC C1608 JB 1H 472K-T	B
C835	4030006880	S.CERAMIC C1608 JB 1H 472K-T	T
C836	4030006880	S.CERAMIC C1608 JB 1H 472K-T	T
C837	4030007100	S.CERAMIC C1608 CH 1H 560J-T	T
C839	4030007110	S.CERAMIC C1608 CH 1H 680J-T	T
C841	4030007100	S.CERAMIC C1608 CH 1H 560J-T	T
C853	4030006880	S.CERAMIC C1608 JB 1H 472K-T	B
C854	4030006880	S.CERAMIC C1608 JB 1H 472K-T	B
C855	4030006880	S.CERAMIC C1608 JB 1H 472K-T	T
C856	4030006880	S.CERAMIC C1608 JB 1H 472K-T	B
C857	4030006880	S.CERAMIC C1608 JB 1H 472K-T	T
C858	4030006880	S.CERAMIC C1608 JB 1H 472K-T	B
C859	4030006880	S.CERAMIC C1608 JB 1H 472K-T	T
C860	4030006880	S.CERAMIC C1608 JB 1H 472K-T	B
C861	4030006880	S.CERAMIC C1608 JB 1H 472K-T	B
C862	4030006880	S.CERAMIC C1608 JB 1H 472K-T	T
C863	4030006880	S.CERAMIC C1608 JB 1H 472K-T	B
C864	4030006880	S.CERAMIC C1608 JB 1H 472K-T	T
C865	4030006880	S.CERAMIC C1608 JB 1H 472K-T	B
C876	4030006880	S.CERAMIC C1608 JB 1H 472K-T	B
C878	4030010760	S.CERAMIC C1608 CH 1H 331J-T	B
C879	4030007050	S.CERAMIC C1608 CH 1H 220J-T	T
C880	4030009520	S.CERAMIC C1608 CH 1H 020B-T	B
C881	4030010210	S.CERAMIC C3216 JB 1C 105M-T	B
C900	4030006880	S.CERAMIC C1608 JB 1H 472K-T	B
C901	4030005110	S.CERAMIC C2012 JB 1E 473K-T	T
C902	4510004640	S.ELECTROLYTIC ECEV1CA470SP	T
C903	4030005110	S.CERAMIC C2012 JB 1E 473K-T	B
C904	4510006230	S.ELECTROLYTIC ECEV1EA470UP	T
C905	4030006880	S.CERAMIC C1608 JB 1H 472K-T	T
C906	4030006880	S.CERAMIC C1608 JB 1H 472K-T	B
C907	4030006900	S.CERAMIC C1608 JB 1H 103K-T	B
C908	4030011600	S.CERAMIC C1608 JB 1E 104K-T	T
C909	4030006880	S.CERAMIC C1608 JB 1H 472K-T	B
C910	4030006900	S.CERAMIC C1608 JB 1H 103K-T	T
C911	4030006900	S.CERAMIC C1608 JB 1H 103K-T	B
C912	4030006880	S.CERAMIC C1608 JB 1H 472K-T	B
C914	4030006880	S.CERAMIC C1608 JB 1H 472K-T	B
C915	4030006900	S.CERAMIC C1608 JB 1H 103K-T	T
C916	4030006880	S.CERAMIC C1608 JB 1H 472K-T	T
C917	4030006900	S.CERAMIC C1608 JB 1H 103K-T	T
C918	4030006900	S.CERAMIC C1608 JB 1H 103K-T	B
C919	4030006880	S.CERAMIC C1608 JB 1H 472K-T	B
C921	4030006880	S.CERAMIC C1608 JB 1H 472K-T	T
C922	4030011600	S.CERAMIC C1608 JB 1E 104K-T	T
C923	4030011600	S.CERAMIC C1608 JB 1E 104K-T	B
C924	4030011600	S.CERAMIC C1608 JB 1E 104K-T	B
C925	4030011600	S.CERAMIC C1608 JB 1E 104K-T	T
C926	4030011600	S.CERAMIC C1608 JB 1E 104K-T	T
C927	4030006960	S.CERAMIC C1608 CH 1H 050C-T	B
C928	4030006960	S.CERAMIC C1608 CH 1H 050C-T	B
C950	4030006880	S.CERAMIC C1608 JB 1H 472K-T	B
C951	4030006900	S.CERAMIC C1608 JB 1H 103K-T	B
C952	4030011600	S.CERAMIC C1608 JB 1E 104K-T	B
C953	4030006880	S.CERAMIC C1608 JB 1H 472K-T	B
C954	4030006900	S.CERAMIC C1608 JB 1H 103K-T	B
C955	4030006900	S.CERAMIC C1608 JB 1H 103K-T	B
C956	4030006880	S.CERAMIC C1608 JB 1H 472K-T	T
C958	4030006880	S.CERAMIC C1608 JB 1H 472K-T	B
C959	4030006900	S.CERAMIC C1608 JB 1H 103K-T	B
C960	4030006880	S.CERAMIC C1608 JB 1H 472K-T	B
C961	4030006900	S.CERAMIC C1608 JB 1H 103K-T	B
C962	4030006900	S.CERAMIC C1608 JB 1H 103K-T	B
C963	4030006880	S.CERAMIC C1608 JB 1H 472K-T	B
C965	4030006880	S.CERAMIC C1608 JB 1H 472K-T	T
C967	4030011600	S.CERAMIC C1608 JB 1E 104K-T	T
C968	4030011600	S.CERAMIC C1608 JB 1E 104K-T	T
C969	4030011600	S.CERAMIC C1608 JB 1E 104K-T	B
C970	4030011600	S.CERAMIC C1608 JB 1E 104K-T	T
C971	4030011600	S.CERAMIC C1608 JB 1E 104K-T	T
C972	4030006960	S.CERAMIC C1608 CH 1H 050C-T	B
C973	4030006960	S.CERAMIC C1608 CH 1H 050C-T	B
C974	4030006880	S.CERAMIC C1608 JB 1H 472K-T	B
RL1	6330001750	RELAY FTR-B4CA012Z	T
RL2	6330001750	RELAY FTR-B4CA012Z	T
RL21	6330001750	RELAY FTR-B4CA012Z	T
RL22	6330001750	RELAY FTR-B4CA012Z	T
RL51	6330001750	RELAY FTR-B4CA012Z	T
RL52	6330001750	RELAY FTR-B4CA012Z	T
RL81	6330001750	RELAY FTR-B4CA012Z	T
RL82	6330001750	RELAY FTR-B4CA012Z	T
RL111	6330001750	RELAY FTR-B4CA012Z	T
RL112	6330001750	RELAY FTR-B4CA012Z	T

[BPF UNIT]

REF NO.	ORDER NO.	DESCRIPTION	M.
RL141	6330001750	RELAY FTR-B4CA012Z	T
RL142	6330001750	RELAY FTR-B4CA012Z	T
RL171	6330001750	RELAY FTR-B4CA012Z	T
RL172	6330001750	RELAY FTR-B4CA012Z	T
RL201	6330001750	RELAY FTR-B4CA012Z	T
RL202	6330001750	RELAY FTR-B4CA012Z	T
RL231	6330001750	RELAY FTR-B4CA012Z	T
RL232	6330001750	RELAY FTR-B4CA012Z	T
RL261	6330001750	RELAY FTR-B4CA012Z	T
RL262	6330001750	RELAY FTR-B4CA012Z	T
RL291	6330001750	RELAY FTR-B4CA012Z	T
RL292	6330001750	RELAY FTR-B4CA012Z	T
RL321	6330001750	RELAY FTR-B4CA012Z	T
RL322	6330001750	RELAY FTR-B4CA012Z	T
RL351	6330001750	RELAY FTR-B4CA012Z	T
RL352	6330001750	RELAY FTR-B4CA012Z	T
RL353	6330001750	RELAY FTR-B4CA012Z	T
RL354	6330001750	RELAY FTR-B4CA012Z	T
RL355	6330001750	RELAY FTR-B4CA012Z	T
RL371	6330001750	RELAY FTR-B4CA012Z	T
RL381	6330001770	RELAY S1P-1A-12Y	T
RL401	6330001770	RELAY S1P-1A-12Y	T
RL402	6330001750	RELAY FTR-B4CA012Z	T
RL501	6330001750	RELAY FTR-B4CA012Z	T
RL502	6330001750	RELAY FTR-B4CA012Z	T
RL531	6330001750	RELAY FTR-B4CA012Z	T
RL532	6330001750	RELAY FTR-B4CA012Z	T
RL561	6330001750	RELAY FTR-B4CA012Z	T
RL562	6330001750	RELAY FTR-B4CA012Z	T
RL591	6330001750	RELAY FTR-B4CA012Z	T
RL592	6330001750	RELAY FTR-B4CA012Z	T
RL621	6330001750	RELAY FTR-B4CA012Z	T
RL622	6330001750	RELAY FTR-B4CA012Z	T
RL651	6330001750	RELAY FTR-B4CA012Z	T
RL652	6330001750	RELAY FTR-B4CA012Z	T
RL681	6330001750	RELAY FTR-B4CA012Z	T
RL682	6330001750	RELAY FTR-B4CA012Z	T
RL711	6330001750	RELAY FTR-B4CA012Z	T
RL712	6330001750	RELAY FTR-B4CA012Z	T
RL741	6330001750	RELAY FTR-B4CA012Z	T
RL742	6330001750	RELAY FTR-B4CA012Z	T
RL771	6330001750	RELAY FTR-B4CA012Z	T
RL772	6330001750	RELAY FTR-B4CA012Z	T
RL801	6330001750	RELAY FTR-B4CA012Z	T
RL802	6330001750	RELAY FTR-B4CA012Z	T
RL831	6330001750	RELAY FTR-B4CA012Z	T
RL832	6330001750	RELAY FTR-B4CA012Z	T
RL851	6330001750	RELAY FTR-B4CA012Z	T
RL852	6330001750	RELAY FTR-B4CA012Z	T
RL853	6330001750	RELAY FTR-B4CA012Z	T
RL854	6330001750	RELAY FTR-B4CA012Z	T
RL855	6330001750	RELAY FTR-B4CA012Z	T
RL871	6330001770	RELAY S1P-1A-12Y	T
RL900	6330001750	RELAY FTR-B4CA012Z	T
RL901	6330001750	RELAY FTR-B4CA012Z	T
RL902	6330001750	RELAY FTR-B4CA012Z	T
RL903	6330001750	RELAY FTR-B4CA012Z	T
RL950	6330001750	RELAY FTR-B4CA012Z	T
RL951	6330001750	RELAY FTR-B4CA012Z	T
RL952	6330001750	RELAY FTR-B4CA012Z	T
RL953	6330001750	RELAY FTR-B4CA012Z	T
RL954	6330001750	RELAY FTR-B4CA012Z	T
J1	6510020520	S.CONNECTOR 52808-1291	T
J101	6510007020	CONNECTOR TMP-J01X-V6	T
J102	6510007020	CONNECTOR TMP-J01X-V6	T
J103	6510023750	CONNECTOR 01K1971-10	T
J104	6510023750	CONNECTOR 01K1971-10	T
J105	6510023750	CONNECTOR 01K1971-10	T
J106	6510007020	CONNECTOR TMP-J01X-V6	T
J107	6510007020	CONNECTOR TMP-J01X-V6	T
J108	6510007020	CONNECTOR TMP-J01X-V6	T
J504	6510023750	CONNECTOR 01K1971-10	T
J505	6510023750	CONNECTOR 01K1971-10	T
J506	6510007020	CONNECTOR TMP-J01X-V6	T
J601	6510007020	CONNECTOR TMP-J01X-V6	T
J602	6510007020	CONNECTOR TMP-J01X-V6	T
W506	9025900640	WIRE 61/99/130/W13A/W13A	
W507	9086700300	WIRE 08	
EP1	0910057424	PCB B 5968D	
EP900	6910012350	S.BEAD MMZ1608Y 102BT	B
EP901	6910012350	S.BEAD MMZ1608Y 102BT	B
EP902	6910012350	S.BEAD MMZ1608Y 102BT	B

M.=Mounted side (T: Mounted on the Top side, B: Mounted on the Bottom side)

S.=Surface mount

[BPF UNIT]

REF NO.	ORDER NO.	DESCRIPTION	M.
EP903	6910012350	S.BEAD MMZ1608Y 102BT	B
EP950	6910012350	S.BEAD MMZ1608Y 102BT	B
EP951	6910012350	S.BEAD MMZ1608Y 102BT	T
EP952	6910012350	S.BEAD MMZ1608Y 102BT	B
EP953	6910012350	S.BEAD MMZ1608Y 102BT	B

[MAIN UNIT]

REF NO.	ORDER NO.	DESCRIPTION	M.
IC1	1110003870	S.IC NJM2058M-TE1	T
IC2	1110001900	S.IC μPC4570G2-T1	T
IC3	1130005640	S.IC TC4W53F (TE12L)	T
IC4	1110006300	S.IC NJM2172V-TE1	T
IC5	1130005640	S.IC TC4W53F (TE12L)	T
IC50	1190001930	S.IC PS7122AL-1A-E3	B
IC60	1110003870	S.IC NJM2058M-TE1	B
IC61	1110003870	S.IC NJM2058M-TE1	B
IC100	1130005640	S.IC TC4W53F (TE12L)	T
IC101	1130005640	S.IC TC4W53F (TE12L)	T
IC102	1110001900	S.IC μPC4570G2-T1	T
IC104	1110001900	S.IC μPC4570G2-T1	T
IC105	1110006300	S.IC NJM2172V-TE1	T
IC140	1110006140	IC LA4485	T
IC180	1110006300	S.IC NJM2172V-TE1	T
IC181	1130005640	S.IC TC4W53F (TE12L)	T
IC182	1110006160	S.IC TPA6111A2DGN	T
IC191	1130005640	S.IC TC4W53F (TE12L)	T
IC192	1130005640	S.IC TC4W53F (TE12L)	T
IC201	1130005640	S.IC TC4W53F (TE12L)	T
IC210	1110006300	S.IC NJM2172V-TE1	T
IC230	1110001900	S.IC μPC4570G2-T1	T
IC250	1130001530	S.IC CD74HC4094M96	T
IC251	1160000130	S.IC TD62783AF (S.EL)	T
IC260	1130001530	S.IC CD74HC4094M96	T
IC261	1160000130	S.IC TD62783AF (S.EL)	T
IC290	1130001530	S.IC CD74HC4094M96	T
IC291	1160000130	S.IC TD62783AF (S.EL)	T
IC310	1130001530	S.IC CD74HC4094M96	T
IC311	1160000130	S.IC TD62783AF (S.EL)	T
IC330	1130012000	S.IC M62352AGP C60Q	T
IC331	1130012000	S.IC M62352AGP C60Q	T
IC450	1180002650	S.REG SI-3012KS-TL	B
IC451	1180002650	S.REG SI-3012KS-TL	B
IC452	1180002650	S.REG SI-3012KS-TL	B
IC460	1130005640	S.IC TC4W53F (TE12L)	T
IC490	1130005640	S.IC TC4W53F (TE12L)	T
IC491	1110003870	S.IC NJM2058M-TE1	B
IC495	1130001990	S.IC SN74LVC1G08DCKR	T
IC501	1110006100	S.IC NJM5534MD-TE1	T
IC502	1110006100	S.IC NJM5534MD-TE1	T
IC503	1110005460	S.IC TA4107F (TE12L)	T
IC550	1180001770	S.IC TA79L05F (TE12L)	T
IC820	1110006130	S.IC μPC4094G2-E1	T
IC821	1110006300	S.IC NJM2172V-TE1	T
Q1	1590001050	S.TRANSISTOR DTC114TUA T106	B
Q2	1590001050	S.TRANSISTOR DTC114TUA T106	B
Q3	1530002060	S.TRANSISTOR 2SC4081 T106 R	B
Q4	1530002060	S.TRANSISTOR 2SC4081 T106 R	B
Q5	1590001330	S.TRANSISTOR DTA114EUA T106	B
Q6	1540000440	S.TRANSISTOR 2SD1619-T-TD	B
Q7	1530002060	S.TRANSISTOR 2SC4081 T106 R	B
Q8	1530002060	S.TRANSISTOR 2SC4081 T106 R	T
Q9	1530002060	S.TRANSISTOR 2SC4081 T106 R	T
Q50	1590001050	S.TRANSISTOR DTC114TUA T106	B
Q51	1590001050	S.TRANSISTOR DTC114TUA T106	B
Q52	1530002060	S.TRANSISTOR 2SC4081 T106 R	B
Q60	1590002710	S.TRANSISTOR UMH11NTN	T
Q61	1590002150	S.TRANSISTOR DTC144TE TL	T
Q62	1510000510	S.TRANSISTOR 2SA1576A T106R	T
Q63	1590001050	S.TRANSISTOR DTC114TUA T106	T
Q64	1590002430	S.TRANSISTOR DTA144EE TL	T
Q100	1590001450	S.FET 2SJ144-GR (TE85R)	T
Q101	1590001450	S.FET 2SJ144-GR (TE85R)	T
Q131	1560001130	S.FET CPH3403-TL	T
Q132	1560001130	S.FET CPH3403-TL	T
Q140	1540000470	S.TRANSISTOR 2SD1801S-TL	T
Q141	1590000680	S.TRANSISTOR DTC114EUA T106	B
Q142	1590000680	S.TRANSISTOR DTC114EUA T106	B
Q143	1590001050	S.TRANSISTOR DTC114TUA T106	T

[MAIN UNIT]

REF NO.	ORDER NO.	DESCRIPTION	M.
Q474	1510000510	S.TRANSISTOR 2SA1576A T106R	T
Q475	1510000510	S.TRANSISTOR 2SA1576A T106R	T
Q476	1590001050	S.TRANSISTOR DTC114TUA T106	T
Q477	1590001050	S.TRANSISTOR DTC114TUA T106	T
Q490	1590000680	S.TRANSISTOR DTC114EUA T106	B
Q491	1520000460	S.TRANSISTOR 2SB1132 T100 R	B
Q501	1580000750	S.FET 3SK294 (TE85L)	B
Q502	1590000680	S.TRANSISTOR DTC114EUA T106	B
Q503	1590002710	S.TRANSISTOR UMH11NTN	T
Q504	1560000560	S.FET 2SK882-GR (TE85L)	B
Q506	1560000560	S.FET 2SK882-GR (TE85L)	B
Q507	1530003150	S.TRANSISTOR 2SC4673D-TD	T
Q508	1530003840	S.TRANSISTOR 2SC5501-4-TR	T
Q801	1530003850	S.TRANSISTOR 2SC5551F-TD	T
Q802	1520000530	S.TRANSISTOR 2SB1119S-TD	B
Q803	1590000680	S.TRANSISTOR DTC114EUA T106	B
Q804	1590002710	S.TRANSISTOR UMH11NTN	T
Q805	1590000680	S.TRANSISTOR DTC114EUA T106	T
Q806	1530002060	S.TRANSISTOR 2SC4081 T106 R	T
Q808	1590001330	S.TRANSISTOR DTA114EUA T106	T
Q809	1590000680	S.TRANSISTOR DTC114EUA T106	T
Q810	1530002060	S.TRANSISTOR 2SC4081 T106 R	T
D1	1750000550	S.DIODE 1SS355 TE-17	B
D2	1750000550	S.DIODE 1SS355 TE-17	B
D3	1790001750	S.DIODE DSM3MA4	B
D4	1790001750	S.DIODE DSM3MA4	B
D50	1750000550	S.DIODE 1SS355 TE-17	B
D51	1790001670	S.DIODE RB706F-40T106	T
D52	1750000550	S.DIODE 1SS355 TE-17	T
D60	1750000550	S.DIODE 1SS355 TE-17	B
D61	1750000550	S.DIODE 1SS355 TE-17	B
D62	1750000550	S.DIODE 1SS355 TE-17	B
D63	1750000550	S.DIODE 1SS355 TE-17	B
D64	1790001240	S.DIODE MA25728-(TX)	B
D65	1750000550	S.DIODE 1SS355 TE-17	B
D66	1750000550	S.DIODE 1SS355 TE-17	B
D67	1730002340	S.ZENER MA8047-M (TX)	T
D140	1750000550	S.DIODE 1SS355 TE-17	B
D141	1750000550	S.DIODE 1SS355 TE-17	B
D241	1730002280	S.ZENER MA8091-M (TX)	T
D450	1710000840	S.DIODE 1SR154-400 TE25	B
D451	1710000840	S.DIODE 1SR154-400 TE25	B
D452	1710000840	S.DIODE 1SR154-400 TE25	B
D490	1790000620	S.DIODE MA77 (TX)	B
D501	1790000620	S.DIODE MA77 (TX)	B
D502	1790000620	S.DIODE MA77 (TX)	B
D503	1790000620	S.DIODE MA77 (TX)	B
D504	1790000620	S.DIODE MA77 (TX)	B
D505	1750000430	S.DIODE HSB88WSTR	T
D506	1750000430	S.DIODE HSB88WSTR	T
D601	1790000620	S.DIODE MA77 (TX)	B
D602	1790000620	S.DIODE MA77 (TX)	B
D603	1790000620	S.DIODE MA77 (TX)	B
D604	1790000620	S.DIODE MA77 (TX)	B
D605	1790000620	S.DIODE MA77 (TX)	B
D606	1790000620	S.DIODE MA77 (TX)	B
D607	1790000620	S.DIODE MA77 (TX)	B
D608	1790000620	S.DIODE MA77 (TX)	B
D609	1790000620	S.DIODE MA77 (TX)	B
D610	1790000620	S.DIODE MA77 (TX)	B
D611	1790000620	S.DIODE MA77 (TX)	T
D612	1790000620	S.DIODE MA77 (TX)	T
D613	1790000620	S.DIODE MA77 (TX)	T
D614	1790000620	S.DIODE MA77 (TX)	T
D615	1790000620	S.DIODE MA77 (TX)	T
D616	1790000620	S.DIODE MA77 (TX)	T
D617	1790000620	S.DIODE MA77 (TX)	T
D618	1790000620	S.DIODE MA77 (TX)	T
D619	1790000620	S.DIODE MA77 (TX)	T
D620	1790000620	S.DIODE MA77 (TX)	T
D801	1790000620	S.DIODE MA77 (TX)	T
D802	1790000620	S.DIODE MA77 (TX)	T
D806	1790000620	S.DIODE MA77 (TX)	B
D820	1790000620	S.DIODE MA77 (TX)	T
FI501	2020001070	CERAMIC CFWLA455KJFA-B0 (CFWS455D)	T
FI502	2020001510	CERAMIC CFWLA455KJFA-B0 (CFWS455IT)	T
FI503	2010002580	S.FILTER FL-348 (64.455 MHz)	T
L1	6200003260	S.COIL NL 322522T-101J	B
L2	6200003260	S.COIL NL 322522T-101J	B
L3	6200003950	S.COIL HF50ACC 322513-T	B
L4	6200003260	S.COIL NL 322522T-101J	T
L5	6200003260	S.COIL NL 322522T-101J	B

M.-Mounted side (T: Mounted on the Top side, B: Mounted on the Bottom side)

S.-Surface mount

[MAIN UNIT]

REF NO.	ORDER NO.	DESCRIPTION	M.
L6	6200003260	S.COIL NL 322522T-101J	B
L7	6200003950	S.COIL HF50ACC 322513-T	B
L8	6200003260	S.COIL NL 322522T-101J	B
L9	6200003950	S.COIL HF50ACC 322513-T	B
L10	6200003260	S.COIL NL 322522T-101J	B
L11	6200003260	S.COIL NL 322522T-101J	B
L12	6200003260	S.COIL NL 322522T-101J	B
L13	6200003950	S.COIL HF50ACC 322513-T	B
L14	6200003260	S.COIL NL 322522T-101J	T
L15	6200003260	S.COIL NL 322522T-101J	B
L16	6200003260	S.COIL NL 322522T-101J	B
L17	6200003950	S.COIL HF50ACC 322513-T	T
L18	6200003260	S.COIL NL 322522T-101J	B
L19	6200003950	S.COIL HF50ACC 322513-T	B
L20	6200003260	S.COIL NL 322522T-101J	B
L21	6200003950	S.COIL HF50ACC 322513-T	B
L22	6200003950	S.COIL HF50ACC 322513-T	B
L31	6200003260	S.COIL NL 322522T-101J	B
L50	6200003260	S.COIL NL 322522T-101J	B
L51	6200003590	S.COIL EXCCL3225U1	B
L52	6200003260	S.COIL NL 322522T-101J	B
L53	6200003260	S.COIL NL 322522T-101J	B
L54	6200003260	S.COIL NL 322522T-101J	T
L55	6200003260	S.COIL NL 322522T-101J	B
L56	6200003590	S.COIL EXCCL3225U1	B
L140	6200003260	S.COIL NL 322522T-101J	T
L141	2040000490	COIL EXC-ELDR25C	T
L142	2040000490	COIL EXC-ELDR25C	T
L143	2040000490	COIL EXC-ELDR25C	T
L180	6200003260	S.COIL NL 322522T-101J	T
L181	6200003260	S.COIL NL 322522T-101J	T
L201	6200003260	S.COIL NL 322522T-101J	T
L210	6200003260	S.COIL NL 322522T-101J	T
L250	6200003590	S.COIL EXCCL3225U1	T
L290	6200003590	S.COIL EXCCL3225U1	T
L330	6200001830	S.COIL NL 322522T-100J	B
L331	6200001830	S.COIL NL 322522T-100J	B
L340	6200003950	S.COIL HF50ACC 322513-T	B
L341	6200003950	S.COIL HF50ACC 322513-T	B
L360	6200003950	S.COIL HF50ACC 322513-T	B
L361	6200003950	S.COIL HF50ACC 322513-T	B
L380	6200003950	S.COIL HF50ACC 322513-T	B
L381	6200003950	S.COIL HF50ACC 322513-T	B
L400	6200003950	S.COIL HF50ACC 322513-T	B
L401	6200003950	S.COIL HF50ACC 322513-T	T
L402	6200003950	S.COIL HF50ACC 322513-T	B
L405	6200003950	S.COIL HF50ACC 322513-T	T
L406	6200003950	S.COIL HF50ACC 322513-T	T
L407	6200003950	S.COIL HF50ACC 322513-T	T
L410	6200003590	S.COIL EXCCL3225U1	T
L411	6200003950	S.COIL HF50ACC 322513-T	B
L412	6200003590	S.COIL EXCCL3225U1	T
L413	6200003950	S.COIL HF50ACC 322513-T	B
L418	6200003950	S.COIL HF50ACC 322513-T	B
L435	6200003950	S.COIL HF50ACC 322513-T	B
L440	6200003950	S.COIL HF50ACC 322513-T	T
L441	6200003950	S.COIL HF50ACC 322513-T	T
L450	6200003590	S.COIL EXCCL3225U1	B
L451	6170000150	COIL LW-16	T
L452	6200003590	S.COIL EXCCL3225U1	T
L453	6200003590	S.COIL EXCCL3225U1	T
L454	6200009790	S.COIL BLM31PG121 SN1	B
L455	6200009790	S.COIL BLM31PG121 SN1	B
L456	6200003590	S.COIL EXCCL3225U1	T
L480	6200003950	S.COIL HF50ACC 322513-T	B
L481	6200003950	S.COIL HF50ACC 322513-T	B
L482	6200003950	S.COIL HF50ACC 322513-T	B
L495	6200003190	S.COIL NL 322522T-470J	B
L496	6200003190	S.COIL NL 322522T-470J	B
L501	6200003260	S.COIL NL 322522T-101J	T
L502	6200003260	S.COIL NL 322522T-101J	T
L503	6200003260	S.COIL NL 322522T-101J	T
L504	6200003520	S.COIL ELJFB 102K-F	T
L505	6150004090	COIL LS-469 (C-13969)	T
L507	6140003530	COIL LR-395	T
L508	6140003210	S.COIL LR-358	T
L509	6140003770	S.COIL LR-414 4KBL (STP-01435)	T
L510	6140003770	S.COIL LR-414 4KBL (STP-01435)	T
L511	6200003030	S.COIL NL 322522T-R47J-3	B
L512	6150004280	COIL LS-484B (C-14927)	T
L513	6140002550	S.COIL B4F-617DB-1010=P3	T
L514	6140002550	S.COIL B4F-617DB-1010=P3	T
L515	6200003000	S.COIL NL 322522T-R22J-3	T
L516	6200003020	S.COIL NL 322522T-R33J-3	T
L517	6200001830	S.COIL NL 322522T-100J	T
L518	6200010720	S.COIL C2520C-56NG-A	T
L519	6200010860	S.COIL C2520C-R10G (01.U)	T
L520	6200003240	S.COIL NL 322522T-221J	B

[MAIN UNIT]

REF NO.	ORDER NO.	DESCRIPTION	M.
L521	6140003900	COIL LR-489	T
L522	6140003980	COIL LR-488	T
L523	6200010380	S.COIL ELJRE R15J-F3	B
L524	6180002970	S.COIL NL 322522T-068J	B
L525	6180002970	S.COIL NL 322522T-068J	B
L526	6180002970	S.COIL NL 322522T-068J	B
L527	6200010660	S.COIL C2520C-R15G (0.15U)	T
L528	6200003260	S.COIL NL 322522T-101J	T
L529	6200010380	S.COIL ELJRE R15J-F3	B
L601	6200003100	S.COIL NL 322522T-3R9J-3	B
L602	6200003130	S.COIL NL 322522T-120J	B
L603	6200003130	S.COIL NL 322522T-120J	B
L604	6200003130	S.COIL NL 322522T-120J	B
L605	6200003100	S.COIL NL 322522T-3R9J-3	B
L606	6200002960	S.COIL NL 322522T-4R7J-3	B
L607	6200001850	S.COIL NL 322522T-5R6J	B
L608	6200001850	S.COIL NL 322522T-5R6J	B
L609	6200001850	S.COIL NL 322522T-5R6J	B
L610	6200002960	S.COIL NL 322522T-4R7J-3	B
L611	6200002990	S.COIL NL 322522T-2R2J-3	B
L612	6200003110	S.COIL NL 322522T-6R8J	B
L613	6200003110	S.COIL NL 322522T-6R8J	B
L614	6200003110	S.COIL NL 322522T-6R8J	B
L615	6200002990	S.COIL NL 322522T-2R2J-3	B
L616	6200002990	S.COIL NL 322522T-2R2J-3	B
L617	6200003320	S.COIL NL 322522T-3R3J-3	B
L618	6200003320	S.COIL NL 322522T-3R3J-3	B
L619	6200003320	S.COIL NL 322522T-3R3J-3	B
L620	6200002990	S.COIL NL 322522T-2R2J-3	B
L621	6200003060	S.COIL NL 322522T-1R2J-3	B
L622	6200003090	S.COIL NL 322522T-2R7J-3	B
L623	6200003090	S.COIL NL 322522T-2R7J-3	B
L624	6200003090	S.COIL NL 322522T-2R7J-3	B
L625	6200003060	S.COIL NL 322522T-1R2J-3	B
L626	6200003330	S.COIL NL 322522T-1R0J-3	T
L627	6200003080	S.COIL NL 322522T-1R8J-3	T
L628	6200003080	S.COIL NL 322522T-1R8J-3	T
L629	6200003080	S.COIL NL 322522T-1R8J-3	T
L630	6200003330	S.COIL NL 322522T-1R0J-3	T
L631	6200003040	S.COIL NL 322522T-R68J-3	T
L632	6200003070	S.COIL NL 322522T-1R5J-3	T
L633	6200003070	S.COIL NL 322522T-1R5J-3	T
L634	6200003070	S.COIL NL 322522T-1R5J-3	T
L635	6200003040	S.COIL NL 322522T-R68J-3	T
L636	6200002980	S.COIL NL 322522T-R56J-3	T
L637	6200003050	S.COIL NL 322522T-R82J-3	T
L638	6200003050	S.COIL NL 322522T-R82J-3	T
L639	6200003050	S.COIL NL 322522T-R82J-3	T
L640	6200002980	S.COIL NL 322522T-R56J-3	T
L641	6200003020	S.COIL NL 322522T-R33J-3	T
L642	6200003040	S.COIL NL 322522T-R68J-3	T
L643	6200003040	S.COIL NL 322522T-R68J-3	T
L644	6200003040	S.COIL NL 322522T-R68J-3	T
L645	6200003020	S.COIL NL 322522T-R33J-3	T
L646	6200005490	S.COIL NL 322522T-331J	T
L647	6200007810	S.COIL LQH31HN95NK01L (LQN 1H 95NK04)	T
L648	6200009810	S.COIL LQH31HNR61J01L (LQN 1H R61J04)	T
L649	6200009810	S.COIL LQH31HNR61J01L (LQN 1H R61J04)	T
L650	6200009810	S.COIL LQH31HNR61J01L (LQN 1H R61J04)	T
L651	6200007810	S.COIL LQH31HN95NK01L (LQN 1H 95NK04)	T
L801	6200005490	S.COIL NL 322522T-331J	B
L802	6200003260	S.COIL NL 322522T-101J	B
L803	6140003970	COIL LR-494	B
L804	6200003240	S.COIL NL 322522T-221J	B
L820	6200003160	S.COIL NL 322522T-270J	T
L821	6200003190	S.COIL NL 322522T-470J	T
L822	6200003200	S.COIL NL 322522T-560J	T
R1	7030003550	S.RESISTOR ERJ3GEYJ 822 V (8.2 kΩ)	B
R2	7030003550	S.RESISTOR ERJ3GEYJ 822 V (8.2 kΩ)	B
R3	7030003520	S.RESISTOR ERJ3GEYJ 472 V (4.7 kΩ)	B
R4	7030003620	S.RESISTOR ERJ3GEYJ 333 V (33 kΩ)	B
R5	7030003580	S.RESISTOR ERJ3GEYJ 153 V (15 kΩ)	B
R6	7030003520	S.RESISTOR ERJ3GEYJ 472 V (4.7 kΩ)	B
R7	7030003520	S.RESISTOR ERJ3GEYJ 472 V (4.7 kΩ)	B
R8	7030003620	S.RESISTOR ERJ3GEYJ 333 V (33 kΩ)	B
R9	7030003580	S.RESISTOR ERJ3GEYJ 153 V (15 kΩ)	B
R10	7030003520	S.RESISTOR ERJ3GEYJ 472 V (4.7 kΩ)	B
R11	7030009891	S.RESISTOR ERA3YED 151V	B
R12	7030003560	S.RESISTOR ERJ3GEYJ 103 V (10 kΩ)	B
R13	7030003480	S.RESISTOR ERJ3GEYJ 222 V (2.2 kΩ)	B
R14	7030003560	S.RESISTOR ERJ3GEYJ 103 V (10 kΩ)	B
R15	7030003640	S.RESISTOR ERJ3GEYJ 473 V (47 kΩ)	B
R16	7030003680	S.RESISTOR ERJ3GEYJ 104 V (100 kΩ)	T
R17	7030003680	S.RESISTOR ERJ3GEYJ 104 V (100 kΩ)	T
R18	7030003400	S.RESISTOR ERJ3GEYJ 471 V (470 Ω)	T
R19	7030003680	S.RESISTOR ERJ3GEYJ 104 V (100 kΩ)	T

M.=Mounted side (T: Mounted on the Top side, B: Mounted on the Bottom side)

S.=Surface mount

[MAIN UNIT]

REF NO.	ORDER NO.	DESCRIPTION	M.
R20	7030003680	S.RESISTOR ERJ3GGEYJ 104 V (100 kΩ)	T
R21	7030003400	S.RESISTOR ERJ3GGEYJ 471 V (470 Ω)	T
R22	7030003560	S.RESISTOR ERJ3GGEYJ 103 V (10 kΩ)	T
R23	7030003560	S.RESISTOR ERJ3GGEYJ 103 V (10 kΩ)	T
R24	7030003660	S.RESISTOR ERJ3GGEYJ 683 V (68 kΩ)	T
R25	7030003440	S.RESISTOR ERJ3GGEYJ 102 V (1 kΩ)	T
R26	7030003560	S.RESISTOR ERJ3GGEYJ 103 V (10 kΩ)	T
R27	7030003560	S.RESISTOR ERJ3GGEYJ 103 V (10 kΩ)	T
R28	7030003660	S.RESISTOR ERJ3GGEYJ 683 V (68 kΩ)	T
R29	7030003440	S.RESISTOR ERJ3GGEYJ 102 V (1 kΩ)	T
R30	7030003320	S.RESISTOR ERJ3GGEYJ 101 V (100 Ω)	T
R31	7030003560	S.RESISTOR ERJ3GGEYJ 103 V (10 kΩ)	T
R32	7030003560	S.RESISTOR ERJ3GGEYJ 103 V (10 kΩ)	T
R33	7030003560	S.RESISTOR ERJ3GGEYJ 103 V (10 kΩ)	B
R34	7030003440	S.RESISTOR ERJ3GGEYJ 102 V (1 kΩ)	T
R35	7030003580	S.RESISTOR ERJ3GGEYJ 153 V (15 kΩ)	T
R36	7030003580	S.RESISTOR ERJ3GGEYJ 153 V (15 kΩ)	T
R37	7030003320	S.RESISTOR ERJ3GGEYJ 101 V (100 Ω)	T
R38	7030003390	S.RESISTOR ERJ3GGEYJ 391 V (390 Ω)	T
R39	7030003440	S.RESISTOR ERJ3GGEYJ 102 V (1 kΩ)	T
R40	7030003580	S.RESISTOR ERJ3GGEYJ 153 V (15 kΩ)	T
R41	7030003580	S.RESISTOR ERJ3GGEYJ 153 V (15 kΩ)	T
R42	7030003320	S.RESISTOR ERJ3GGEYJ 101 V (100 Ω)	T
R43	7030003390	S.RESISTOR ERJ3GGEYJ 391 V (390 Ω)	T
R44	7030003320	S.RESISTOR ERJ3GGEYJ 101 V (100 Ω)	T
R45	7030003620	S.RESISTOR ERJ3GGEYJ 333 V (33 kΩ)	T
R46	7030003620	S.RESISTOR ERJ3GGEYJ 333 V (33 kΩ)	T
R47	7030003560	S.RESISTOR ERJ3GGEYJ 103 V (10 kΩ)	B
R49	7540000270	S.ABSORBER ERZVF2M201	B
R50	7310003820	TRIMMER EVN-D2AA03 B14	T
R51	7030003560	S.RESISTOR ERJ3GGEYJ 103 V (10 kΩ)	B
R52	7030003200	S.RESISTOR ERJ3GGEYJ 100 V (10 Ω)	B
R53	7030003390	S.RESISTOR ERJ3GGEYJ 391 V (390 Ω)	T
R54	7030003480	S.RESISTOR ERJ3GGEYJ 222 V (2.2 kΩ)	T
R55	7030003480	S.RESISTOR ERJ3GGEYJ 222 V (2.2 kΩ)	T
R56	7030003520	S.RESISTOR ERJ3GGEYJ 472 V (4.7 kΩ)	T
R57	7030003620	S.RESISTOR ERJ3GGEYJ 333 V (33 kΩ)	T
R58	7030003580	S.RESISTOR ERJ3GGEYJ 153 V (15 kΩ)	T
R59	7030003520	S.RESISTOR ERJ3GGEYJ 472 V (4.7 kΩ)	T
R60	7510001510	S.THERMISTOR NTCG16 4LH 223KT	B
R61	7030003660	S.RESISTOR ERJ3GGEYJ 683 V (68 kΩ)	B
R62	7030003500	S.RESISTOR ERJ3GGEYJ 332 V (3.3 kΩ)	B
R63	7030003680	S.RESISTOR ERJ3GGEYJ 104 V (100 kΩ)	B
R64	7030003560	S.RESISTOR ERJ3GGEYJ 103 V (10 kΩ)	B
R65	7030003720	S.RESISTOR ERJ3GGEYJ 224 V (220 kΩ)	B
R66	7030003400	S.RESISTOR ERJ3GGEYJ 471 V (470 Ω)	B
R67	7030003640	S.RESISTOR ERJ3GGEYJ 473 V (47 kΩ)	B
R68	7030003540	S.RESISTOR ERJ3GGEYJ 682 V (6.8 kΩ)	B
R69	731 0002670	S.TRIMMER RV-143 (RH03A3AS2) 471	T
R70	7030003540	S.RESISTOR ERJ3GGEYJ 682 V (6.8 kΩ)	B
R71	7030003640	S.RESISTOR ERJ3GGEYJ 473 V (47 kΩ)	B
R72	7030003800	S.RESISTOR ERJ3GGEYJ 105 V (1 MΩ)	B
R73	7030003520	S.RESISTOR ERJ3GGEYJ 472 V (4.7 kΩ)	T
R74	7030003720	S.RESISTOR ERJ3GGEYJ 224 V (220 kΩ)	B
R75	7030003600	S.RESISTOR ERJ3GGEYJ 223 V (22 kΩ)	T
R76	7030003620	S.RESISTOR ERJ3GGEYJ 333 V (33 kΩ)	T
R77	7030003720	S.RESISTOR ERJ3GGEYJ 224 V (220 kΩ)	B
R78	7030003680	S.RESISTOR ERJ3GGEYJ 104 V (100 kΩ)	T
R79	731 0002800	S.TRIMMER RV-156 (RH03A3AJ5) 224	T
R80	7030003680	S.RESISTOR ERJ3GGEYJ 104 V (100 kΩ)	T
R81	7310002800	S.TRIMMER RV-156 (RH03A3AJ5) 224	T
R82	731 0002580	S.TRIMMER RV-108 (RH03A3A15X05A) 104	T
R83	7030003680	S.RESISTOR ERJ3GGEYJ 104 V (100 kΩ)	B
R84	7030003720	S.RESISTOR ERJ3GGEYJ 224 V (220 kΩ)	B
R85	7030009920	S.RESISTOR ERJ3GGEYJ 335 V (3.3 MΩ)	B
R86	7030003380	S.RESISTOR ERJ3GGEYJ 331 V (330 Ω)	B
R87	7030003320	S.RESISTOR ERJ3GGEYJ 101 V (100 Ω)	T
R88	7030003440	S.RESISTOR ERJ3GGEYJ 102 V (1 kΩ)	T
R89	7030003440	S.RESISTOR ERJ3GGEYJ 102 V (1 kΩ)	T
R90	7030003800	S.RESISTOR ERJ3GGEYJ 105 V (1 MΩ)	B
R91	7030003660	S.RESISTOR ERJ3GGEYJ 683 V (68 kΩ)	B
R92	7030003380	S.RESISTOR ERJ3GGEYJ 331 V (330 Ω)	T
R93	731 0002720	S.TRIMMER RV-148 (RH03A3AS3X0DA) 472	T
R94	7030003320	S.RESISTOR ERJ3GGEYJ 101 V (100 Ω)	B
R95	7030003840	S.RESISTOR ERJ3GGEYJ 225 V (2.2 MΩ)	T
R96	7030009920	S.RESISTOR ERJ3GGEYJ 335 V (3.3 MΩ)	B
R97	7030011040	S.RESISTOR ERJ3GGEYJ 685 V (6.8 MΩ)	B
R98	7030003320	S.RESISTOR ERJ3GGEYJ 101 V (100 Ω)	T
R99	7030000380	S.RESISTOR MCR10EZJH 1 kΩ	B
R100	7030003440	S.RESISTOR ERJ3GGEYJ 102 V (1 kΩ)	T
R101	7030003520	S.RESISTOR ERJ3GGEYJ 472 V (4.7 kΩ)	T
R102	7030003680	S.RESISTOR ERJ3GGEYJ 104 V (100 kΩ)	T
R103	7030003560	S.RESISTOR ERJ3GGEYJ 103 V (10 kΩ)	T
R104	7030003560	S.RESISTOR ERJ3GGEYJ 103 V (10 kΩ)	T
R105	7030003440	S.RESISTOR ERJ3GGEYJ 102 V (1 kΩ)	T
R106	7030003520	S.RESISTOR ERJ3GGEYJ 472 V (4.7 kΩ)	T
R107	7030003680	S.RESISTOR ERJ3GGEYJ 104 V (100 kΩ)	T
R108	7030003560	S.RESISTOR ERJ3GGEYJ 103 V (10 kΩ)	T

[MAIN UNIT]

REF NO.	ORDER NO.	DESCRIPTION	M.
R109	7030003560	S.RESISTOR ERJ3GGEYJ 103 V (10 kΩ)	T
R110	7030003560	S.RESISTOR ERJ3GGEYJ 103 V (10 kΩ)	T
R111	7030003560	S.RESISTOR ERJ3GGEYJ 103 V (10 kΩ)	T
R113	7030003440	S.RESISTOR ERJ3GGEYJ 102 V (1 kΩ)	T
R114	7030003560	S.RESISTOR ERJ3GGEYJ 103 V (10 kΩ)	T
R115	7030003440	S.RESISTOR ERJ3GGEYJ 102 V (1 kΩ)	T
R116	7030003560	S.RESISTOR ERJ3GGEYJ 103 V (10 kΩ)	T
R117	7030003620	S.RESISTOR ERJ3GGEYJ 333 V (33 kΩ)	T
R118	7030003680	S.RESISTOR ERJ3GGEYJ 104 V (100 kΩ)	T
R119	7030003560	S.RESISTOR ERJ3GGEYJ 103 V (10 kΩ)	B
R120	7030003560	S.RESISTOR ERJ3GGEYJ 103 V (10 kΩ)	B
R123	7030003520	S.RESISTOR ERJ3GGEYJ 472 V (4.7 kΩ)	T
R124	7030003520	S.RESISTOR ERJ3GGEYJ 472 V (4.7 kΩ)	T
R125	7030003320	S.RESISTOR ERJ3GGEYJ 101 V (100 Ω)	T
R126	7030003470	S.RESISTOR ERJ3GGEYJ 182 V (1.8 kΩ)	T
R127	7030003470	S.RESISTOR ERJ3GGEYJ 182 V (1.8 kΩ)	T
R128	7030003470	S.RESISTOR ERJ3GGEYJ 182 V (1.8 kΩ)	T
R129	7030003470	S.RESISTOR ERJ3GGEYJ 182 V (1.8 kΩ)	T
R130	7030003480	S.RESISTOR ERJ3GGEYJ 222 V (2.2 kΩ)	B
R131	7030003480	S.RESISTOR ERJ3GGEYJ 222 V (2.2 kΩ)	B
R132	7030000380	S.RESISTOR MCR10EZJH 1 kΩ	B
R133	7030003520	S.RESISTOR ERJ3GGEYJ 472 V (4.7 kΩ)	T
R134	7030003440	S.RESISTOR ERJ3GGEYJ 102 V (1 kΩ)	T
R135	7030003520	S.RESISTOR ERJ3GGEYJ 472 V (4.7 kΩ)	T
R136	7030003440	S.RESISTOR ERJ3GGEYJ 102 V (1 kΩ)	T
R137	7030003480	S.RESISTOR ERJ3GGEYJ 222 V (2.2 kΩ)	T
R138	7030003320	S.RESISTOR ERJ3GGEYJ 101 V (100 Ω)	B
R139	7030003560	S.RESISTOR ERJ3GGEYJ 103 V (10 kΩ)	T
R140	7030003560	S.RESISTOR ERJ3GGEYJ 103 V (10 kΩ)	T
R141	7030003560	S.RESISTOR ERJ3GGEYJ 103 V (10 kΩ)	B
R142	7030003640	S.RESISTOR ERJ3GGEYJ 473 V (47 kΩ)	B
R143	7030004040	S.RESISTOR ERJ3GGEYJ 4R7 V (4.7 Ω)	B
R144	7030004040	S.RESISTOR ERJ3GGEYJ 4R7 V (4.7 Ω)	B
R145	7030003440	S.RESISTOR ERJ3GGEYJ 102 V (1 kΩ)	T
R146	7510001510	S.THERMISTOR NTCG16 4LH 223KT	T
R147	7030003750	S.RESISTOR ERJ3GGEYJ 394 V (390 kΩ)	T
R149	7030003360	S.RESISTOR ERJ3GGEYJ 221 V (220 Ω)	B
R150	7030003360	S.RESISTOR ERJ3GGEYJ 221 V (220 Ω)	B
R151	7030003410	S.RESISTOR ERJ3GGEYJ 561 V (560 Ω)	T
R152	7030003320	S.RESISTOR ERJ3GGEYJ 101 V (100 Ω)	B
R154	7030003320	S.RESISTOR ERJ3GGEYJ 101 V (100 Ω)	T
R155	7030003640	S.RESISTOR ERJ3GGEYJ 473 V (47 kΩ)	T
R156	7030003640	S.RESISTOR ERJ3GGEYJ 473 V (47 kΩ)	T
R157	7030003480	S.RESISTOR ERJ3GGEYJ 222 V (2.2 kΩ)	T
R158	7030003480	S.RESISTOR ERJ3GGEYJ 222 V (2.2 kΩ)	T
R159	7030003440	S.RESISTOR ERJ3GGEYJ 102 V (1 kΩ)	T
R160	7030003440	S.RESISTOR ERJ3GGEYJ 102 V (1 kΩ)	T
R161	7030003480	S.RESISTOR ERJ3GGEYJ 222 V (2.2 kΩ)	T
R162	7030003680	S.RESISTOR ERJ3GGEYJ 104 V (100 kΩ)	T
R163	7030003570	S.RESISTOR ERJ3GGEYJ 123 V (12 kΩ)	T
R164	7030003680	S.RESISTOR ERJ3GGEYJ 104 V (100 kΩ)	T
R165	7030003680	S.RESISTOR ERJ3GGEYJ 104 V (100 kΩ)	T
R166	7030003400	S.RESISTOR ERJ3GGEYJ 471 V (470 Ω)	T
R167	7030003440	S.RESISTOR ERJ3GGEYJ 102 V (1 kΩ)	T
R168	7030003480	S.RESISTOR ERJ3GGEYJ 222 V (2.2 kΩ)	T
R169	7030003680	S.RESISTOR ERJ3GGEYJ 104 V (100 kΩ)	T
R170	7030003570	S.RESISTOR ERJ3GGEYJ 123 V (12 kΩ)	T
R171	7030003680	S.RESISTOR ERJ3GGEYJ 104 V (100 kΩ)	T
R172	7030003680	S.RESISTOR ERJ3GGEYJ 104 V (100 kΩ)	T
R173	7030003400	S.RESISTOR ERJ3GGEYJ 471 V (470 Ω)	T
R174	7030003440	S.RESISTOR ERJ3GGEYJ 102 V (1 kΩ)	T
R175	7030003860	S.RESISTOR ERJ3GE JPW V	B
R176	7030003450	S.RESISTOR ERJ3GGEYJ 122 V (1.2 kΩ)	T
R180	7030003560	S.RESISTOR ERJ3GGEYJ 103 V (10 kΩ)	B
R181	7030003560	S.RESISTOR ERJ3GGEYJ 103 V (10 kΩ)	B
R183	7030003470	S.RESISTOR ERJ3GGEYJ 182 V (1.8 kΩ)	T
R184	7030003470	S.RESISTOR ERJ3GGEYJ 182 V (1.8 kΩ)	T
R185	7030003470	S.RESISTOR ERJ3GGEYJ 182 V (1.8 kΩ)	T
R186	7030003470	S.RESISTOR ERJ3GGEYJ 182 V (1.8 kΩ)	T
R187	7030003480	S.RESISTOR ERJ3GGEYJ 222 V (2.2 kΩ)	T
R188	7030003480	S.RESISTOR ERJ3GGEYJ 222 V (2.2 kΩ)	T
R189	7030003560	S.RESISTOR ERJ3GGEYJ 103 V (10 kΩ)	B
R190	7030003560	S.RESISTOR ERJ3GGEYJ 103 V (10 kΩ)	B
R191	7030003440	S.RESISTOR ERJ3GGEYJ 102 V (1 kΩ)	T
R192	7030003610	S.RESISTOR ERJ3GGEYJ 273 V (27 kΩ)	T
R193	7030003440	S.RESISTOR ERJ3GGEYJ 102 V (1 kΩ)	T
R194	7030003610	S.RESISTOR ERJ3GGEYJ 273 V (27 kΩ)	T
R195	7030003440	S.RESISTOR ERJ3GGEYJ 102 V (1 kΩ)	T
R196	7030003440	S.RESISTOR ERJ3GGEYJ 102 V (1 kΩ)	T
R197	7030003320	S.RESISTOR ERJ3GGEYJ 101 V (100 Ω)	T
R198	7030003640	S.RESISTOR ERJ3GGEYJ 473 V (47 kΩ)	T
R199	7030003520	S.RESISTOR ERJ3GGEYJ 472 V (4.7 kΩ)	T
R200	7030003560	S.RESISTOR ERJ3GGEYJ 103 V (10 kΩ)	B
R201	7030003560	S.RESISTOR ERJ3GGEYJ 103 V (10 kΩ)	T
R202	7030003520	S.RESISTOR ERJ3GGEYJ 472 V (4.7 kΩ)	T
R203	7030003720	S.RESISTOR ERJ3GGEYJ 224 V (220 kΩ)	T
R204	7030003320	S.RESISTOR ERJ3GGEYJ 101 V (100 Ω)	T
R205	7030003320	S.RESISTOR ERJ3GGEYJ 101 V (100 Ω)	B

M.—Mounted side (T: Mounted on the Top side, B: Mounted on the Bottom side)

S.—Surface mount

[MAIN UNIT]

REF NO.	ORDER NO.		DESCRIPTION	M.
R522	7030003200	S.RESISTOR	ERJ3GEYJ 100 V (10 Ω)	B
R523	7030003360	S.RESISTOR	ERJ3GEYJ 221 V (220 Ω)	B
R524	7030003560	S.RESISTOR	ERJ3GEYJ 103 V (10 kΩ)	B
R525	7030003480	S.RESISTOR	ERJ3GEYJ 222 V (2.2 kΩ)	B
R526	7030003440	S.RESISTOR	ERJ3GEYJ 102 V (1 kΩ)	B
R527	7030003560	S.RESISTOR	ERJ3GEYJ 103 V (10 kΩ)	B
R528	7030003660	S.RESISTOR	ERJ3GEYJ 103 V (10 kΩ)	B
R529	7030003560	S.RESISTOR	ERJ3GEYJ 103 V (10 kΩ)	B
R530	7030003560	S.RESISTOR	ERJ3GEYJ 103 V (10 kΩ)	B
R531	7030003560	S.RESISTOR	ERJ3GEYJ 103 V (10 kΩ)	B
R532	7030003440	S.RESISTOR	ERJ3GEYJ 102 V (1 kΩ)	B
R533	7030003560	S.RESISTOR	ERJ3GEYJ 103 V (10 kΩ)	B
R534	7030003560	S.RESISTOR	ERJ3GEYJ 103 V (10 kΩ)	T
R535	7030003440	S.RESISTOR	ERJ3GEYJ 102 V (1 kΩ)	B
R536	7030003490	S.RESISTOR	ERJ3GEYJ 272 V (2.7 kΩ)	B
R537	7030003320	S.RESISTOR	ERJ3GEYJ 101 V (100 Ω)	T
R538	7310002760	S.TRIMMER	RV-152 (RH03A3AJ4X0HA) 223	T
R539	7030003400	S.RESISTOR	ERJ3GEYJ 471 V (470 Ω)	B
R540	7030003220	S.RESISTOR	ERJ3GEYJ 150 V (15 Ω)	B
R541	7030003380	S.RESISTOR	ERJ3GEYJ 331 V (330 Ω)	B
R543	7030003380	S.RESISTOR	ERJ3GEYJ 331 V (330 Ω)	B
R544	7030005671	S.RESISTOR	ERA3YKD 393V (39 kΩ)	B
R545	7030004030	S.RESISTOR	ERJ3GEYJ 5R6 V (5.6 Ω)	B
R546	7030003430	S.RESISTOR	ERJ3GEYJ 821 V (820 Ω)	B
R547	7030003430	S.RESISTOR	ERJ3GEYJ 821 V (820 Ω)	B
R548	7030003860	S.RESISTOR	ERJ3GE JPW V	B
R549	7030003560	S.RESISTOR	ERJ3GEYJ 103 V (10 kΩ)	T
R550	7030003560	S.RESISTOR	ERJ3GEYJ 103 V (10 kΩ)	T
R551	7030003680	S.RESISTOR	ERJ3GEYJ 104 V (100 kΩ)	T
R552	7030004040	S.RESISTOR	ERJ3GEYJ 4R7 V (4.7 Ω)	B
R553	7030009891	S.RESISTOR	ERA3YED 151V	B
R554	7030003440	S.RESISTOR	ERJ3GEYJ 102 V (1 kΩ)	B
R555	7510001490	S.THERMISTOR	NTCG16 3NH 681KT	B
R556	7030003480	S.RESISTOR	ERJ3GEYJ 222 V (2.2 kΩ)	B
R557	7030005331	S.RESISTOR	ERA3YED 562V	B
R558	7030003320	S.RESISTOR	ERJ3GEYJ 101 V (100 Ω)	T
R559	7030003680	S.RESISTOR	ERJ3GEYJ 104 V (100 kΩ)	T
R560	7030003680	S.RESISTOR	ERJ3GEYJ 104 V (100 kΩ)	T
R561	7030003680	S.RESISTOR	ERJ3GEYJ 104 V (100 kΩ)	T
R562	7030003320	S.RESISTOR	ERJ3GEYJ 101 V (100 Ω)	B
R563	7030003300	S.RESISTOR	ERJ3GEYJ 680 V (68 Ω)	T
R564	7030003620	S.RESISTOR	ERJ3GEYJ 333 V (33 kΩ)	T
R565	7030003640	S.RESISTOR	ERJ3GEYJ 473 V (47 kΩ)	B
R566	7030003330	S.RESISTOR	ERJ3GEYJ 121 V (120 Ω)	T
R567	7030003230	S.RESISTOR	ERJ3GEYJ 180 V (18 Ω)	B
R568	7030009851	S.RESISTOR	ERA3YED 271V	B
R569	7030009851	S.RESISTOR	ERA3YED 271V	B
R570	7030003520	S.RESISTOR	ERJ3GEYJ 472 V (4.7 kΩ)	T
R571	7030003560	S.RESISTOR	ERJ3GEYJ 103 V (10 kΩ)	B
R572	7030003200	S.RESISTOR	ERJ3GEYJ 100 V (10 Ω)	T
R573	7030003400	S.RESISTOR	ERJ3GEYJ 471 V (470 Ω)	B
R574	7030003400	S.RESISTOR	ERJ3GEYJ 471 V (470 Ω)	T
R575	7030009851	S.RESISTOR	ERA3YED 271V	B
R576	7030003230	S.RESISTOR	ERJ3GEYJ 180 V (18 Ω)	B
R577	7030009851	S.RESISTOR	ERA3YED 271V	B
R578	7030003230	S.RESISTOR	ERJ3GEYJ 180 V (18 Ω)	B
R579	7030009851	S.RESISTOR	ERA3YED 271V	B
R580	7030009851	S.RESISTOR	ERA3YED 271V	B
R581	7030003430	S.RESISTOR	ERJ3GEYJ 821 V (820 Ω)	B
R582	7030004030	S.RESISTOR	ERJ3GEYJ 5R6 V (5.6 Ω)	B
R583	7030003430	S.RESISTOR	ERJ3GEYJ 821 V (820 Ω)	B
R584	7510001670	S.THRMISTOR	NTCG16 4BH 103KT	T
R585	7030003600	S.RESISTOR	ERJ3GEYJ 223 V (22 kΩ)	B
R587	7030004030	S.RESISTOR	ERJ3GEYJ 5R6 V (5.6 Ω)	B
R589	7030003400	S.RESISTOR	ERJ3GEYJ 471 V (470 Ω)	B
R601	7030000260	S.RESISTOR	MCR10EZJH 100 Ω (101)	B
R602	7030000260	S.RESISTOR	MCR10EZJH 100 Ω (101)	B
R603	7030000260	S.RESISTOR	MCR10EZJH 100 Ω (101)	B
R604	7030000260	S.RESISTOR	MCR10EZJH 100 Ω (101)	B
R605	7030000260	S.RESISTOR	MCR10EZJH 100 Ω (101)	B
R606	7030000260	S.RESISTOR	MCR10EZJH 100 Ω (101)	T
R607	7030000260	S.RESISTOR	MCR10EZJH 100 Ω (101)	T
R608	7030000260	S.RESISTOR	MCR10EZJH 100 Ω (101)	T
R609	7030000260	S.RESISTOR	MCR10EZJH 100 Ω (101)	T
R610	7030003400	S.RESISTOR	ERJ3GEYJ 471 V (470 Ω)	T
R611	7030000260	S.RESISTOR	MCR10EZJH 100 Ω (101)	T
R612	7030009851	S.RESISTOR	ERA3YED 271V	T
R613	7030003230	S.RESISTOR	ERJ3GEYJ 180 V (18 Ω)	T
R614	7030009851	S.RESISTOR	ERA3YED 271V	T
R801	7030003380	S.RESISTOR	ERJ3GEYJ 331 V (330 Ω)	T
R802	7030009891	S.RESISTOR	ERA3YED 151V	B
R803	7030003440	S.RESISTOR	ERJ3GEYJ 102 V (1 kΩ)	B
R804	7030003490	S.RESISTOR	ERJ3GEYJ 272 V (2.7 kΩ)	B
R805	7030003300	S.RESISTOR	ERJ3GEYJ 680 V (68 Ω)	T
R806	7030003320	S.RESISTOR	ERJ3GEYJ 101 V (100 Ω)	T
R807	7030003320	S.RESISTOR	ERJ3GEYJ 101 V (100 Ω)	T
R808	7030003640	S.RESISTOR	ERJ3GEYJ 473 V (47 kΩ)	B
R809	7030003460	S.RESISTOR	ERJ3GEYJ 152 V (1.5 kΩ)	B

M.-Mounted side (T: Mounted on the Top side, B: Mounted on the Bottom side)

[MAIN UNIT]

REF NO.	ORDER NO.		DESCRIPTION	M.
R810	7030003680	S.RESISTOR	ERJ3GEYJ 104 V (100 kΩ)	T
R811	7030003560	S.RESISTOR	ERJ3GEYJ 103 V (10 kΩ)	T
R812	7030009851	S.RESISTOR	ERA3YED 271V	T
R813	7030003230	S.RESISTOR	ERJ3GEYJ 180 V (18 Ω)	T
R814	7030009851	S.RESISTOR	ERA3YED 271V	T
R815	7030003320	S.RESISTOR	ERJ3GEYJ 101 V (100 Ω)	T
R816	7030003680	S.RESISTOR	ERJ3GEYJ 104 V (100 kΩ)	T
R817	7030003860	S.RESISTOR	ERJ3GE JPW V	T
R818	7030003320	S.RESISTOR	ERJ3GEYJ 101 V (100 Ω)	B
R820	7030003440	S.RESISTOR	ERJ3GEYJ 102 V (1 kΩ)	T
R821	7030003320	S.RESISTOR	ERJ3GEYJ 101 V (100 Ω)	T
R822	7030003560	S.RESISTOR	ERJ3GEYJ 103 V (10 kΩ)	T
R823	7030003280	S.RESISTOR	ERJ3GEYJ 470 V (47 Ω)	T
R824	7030003320	S.RESISTOR	ERJ3GEYJ 101 V (100 Ω)	T
R825	7030003320	S.RESISTOR	ERJ3GEYJ 101 V (100 Ω)	T
R826	7030003230	S.RESISTOR	ERJ3GEYJ 180 V (18 Ω)	T
R827	7030009851	S.RESISTOR	ERA3YED 271V	T
R828	7030009851	S.RESISTOR	ERA3YED 271V	T
R832	7030003290	S.RESISTOR	ERJ3GEYJ 560 V (56 Ω)	B
R833	7030003480	S.RESISTOR	ERJ3GEYJ 222 V (2.2 kΩ)	B
R834	7030003440	S.RESISTOR	ERJ3GEYJ 102 V (1 kΩ)	B
R835	7030003440	S.RESISTOR	ERJ3GEYJ 102 V (1 kΩ)	B
R836	7030003500	S.RESISTOR	ERJ3GEYJ 332 V (3.3 kΩ)	B
R837	7030003480	S.RESISTOR	ERJ3GEYJ 222 V (2.2 kΩ)	T
R838	7030003510	S.RESISTOR	ERJ3GEYJ 392 V (3.9 kΩ)	T
R839	7030003480	S.RESISTOR	ERJ3GEYJ 222 V (2.2 kΩ)	T
R840	7030003400	S.RESISTOR	ERJ3GEYJ 471 V (470 Ω)	T
R841	7030003300	S.RESISTOR	ERJ3GEYJ 680 V (68 Ω)	T
R851	7030003400	S.RESISTOR	ERJ3GEYJ 471 V (470 Ω)	T
R852	7030003560	S.RESISTOR	ERJ3GEYJ 103 V (10 kΩ)	T
R900	7030003320	S.RESISTOR	ERJ3GEYJ 101 V (100 Ω)	T
R901	7030003320	S.RESISTOR	ERJ3GEYJ 101 V (100 Ω)	B
R902	7030003320	S.RESISTOR	ERJ3GEYJ 101 V (100 Ω)	T
R903	7030003320	S.RESISTOR	ERJ3GEYJ 101 V (100 Ω)	B
R904	7030003320	S.RESISTOR	ERJ3GEYJ 101 V (100 Ω)	T
R906	7030003320	S.RESISTOR	ERJ3GEYJ 101 V (100 Ω)	T
R908	7030003320	S.RESISTOR	ERJ3GEYJ 101 V (100 Ω)	T
R909	7030003320	S.RESISTOR	ERJ3GEYJ 101 V (100 Ω)	B
R910	7030003320	S.RESISTOR	ERJ3GEYJ 101 V (100 Ω)	T
R911	7030003320	S.RESISTOR	ERJ3GEYJ 101 V (100 Ω)	B
R912	7030003320	S.RESISTOR	ERJ3GEYJ 101 V (100 Ω)	T
R913	7030003320	S.RESISTOR	ERJ3GEYJ 101 V (100 Ω)	B
R914	7030003320	S.RESISTOR	ERJ3GEYJ 101 V (100 Ω)	T
R915	7030003320	S.RESISTOR	ERJ3GEYJ 101 V (100 Ω)	B
R916	7030003320	S.RESISTOR	ERJ3GEYJ 101 V (100 Ω)	T
R917	7030003320	S.RESISTOR	ERJ3GEYJ 101 V (100 Ω)	B
R918	7030003320	S.RESISTOR	ERJ3GEYJ 101 V (100 Ω)	T
R920	7030003320	S.RESISTOR	ERJ3GEYJ 101 V (100 Ω)	T
R921	7030003320	S.RESISTOR	ERJ3GEYJ 101 V (100 Ω)	B
R922	7030003320	S.RESISTOR	ERJ3GEYJ 101 V (100 Ω)	T
R923	7030003320	S.RESISTOR	ERJ3GEYJ 101 V (100 Ω)	B
R924	7030003320	S.RESISTOR	ERJ3GEYJ 101 V (100 Ω)	T
R925	7030003320	S.RESISTOR	ERJ3GEYJ 101 V (100 Ω)	B
R926	7030003320	S.RESISTOR	ERJ3GEYJ 101 V (100 Ω)	T
R927	7030003320	S.RESISTOR	ERJ3GEYJ 101 V (100 Ω)	B
R928	7030003320	S.RESISTOR	ERJ3GEYJ 101 V (100 Ω)	T
R929	7030003320	S.RESISTOR	ERJ3GEYJ 101 V (100 Ω)	B
R930	7030003320	S.RESISTOR	ERJ3GEYJ 101 V (100 Ω)	T
R932	7030003320	S.RESISTOR	ERJ3GEYJ 101 V (100 Ω)	T
R933	7030003320	S.RESISTOR	ERJ3GEYJ 101 V (100 Ω)	B
R934	7030003320	S.RESISTOR	ERJ3GEYJ 101 V (100 Ω)	T
R936	7030003320	S.RESISTOR	ERJ3GEYJ 101 V (100 Ω)	T
R937	7030003320	S.RESISTOR	ERJ3GEYJ 101 V (100 Ω)	B
R938	7030003320	S.RESISTOR	ERJ3GEYJ 101 V (100 Ω)	T
R939	7030003320	S.RESISTOR	ERJ3GEYJ 101 V (100 Ω)	B
R940	7030003320	S.RESISTOR	ERJ3GEYJ 101 V (100 Ω)	T
R941	7030003320	S.RESISTOR	ERJ3GEYJ 101 V (100 Ω)	B
R942	7030003320	S.RESISTOR	ERJ3GEYJ 101 V (100 Ω)	T
R943	7030003320	S.RESISTOR	ERJ3GEYJ 101 V (100 Ω)	B
R944	7030003320	S.RESISTOR	ERJ3GEYJ 101 V (100 Ω)	T
R945	7030003320	S.RESISTOR	ERJ3GEYJ 101 V (100 Ω)	B
R946	7030003320	S.RESISTOR	ERJ3GEYJ 101 V (100 Ω)	T
R947	7030003320	S.RESISTOR	ERJ3GEYJ 101 V (100 Ω)	B
R948	7030003320	S.RESISTOR	ERJ3GEYJ 101 V (100 Ω)	T
R949	7030003320	S.RESISTOR	ERJ3GEYJ 101 V (100 Ω)	B
R950	7030003320	S.RESISTOR	ERJ3GEYJ 101 V (100 Ω)	T
R951	7030003320	S.RESISTOR	ERJ3GEYJ 101 V (100 Ω)	B
R952	7030003320	S.RESISTOR	ERJ3GEYJ 101 V (100 Ω)	T
R953	7030003320	S.RESISTOR	ERJ3GEYJ 101 V (100 Ω)	B
R954	7030003320	S.RESISTOR	ERJ3GEYJ 101 V (100 Ω)	T
R955	7030003320	S.RESISTOR	ERJ3GEYJ 101 V (100 Ω)	B
R957	7030003320	S.RESISTOR	ERJ3GEYJ 101 V (100 Ω)	B
R958	7030003320	S.RESISTOR	ERJ3GEYJ 101 V (100 Ω)	T
R960	7030003320	S.RESISTOR	ERJ3GEYJ 101 V (100 Ω)	T
R961	7030003320	S.RESISTOR	ERJ3GEYJ 101 V (100 Ω)	B
R962	7030003320	S.RESISTOR	ERJ3GEYJ 101 V (100 Ω)	T
R963	7030003320	S.RESISTOR	ERJ3GEYJ 101 V (100 Ω)	B
R964	7030003320	S.RESISTOR	ERJ3GEYJ 101 V (100 Ω)	T

S.-Surface mount

[MAIN UNIT]

REF NO.	ORDER NO.	DESCRIPTION	M.
R966	7030003320	S.RESISTOR ERJ3GEYJ 101 V (100 Ω)	T
R967	7030003320	S.RESISTOR ERJ3GEYJ 101 V (100 Ω)	B
R968	7030003320	S.RESISTOR ERJ3GEYJ 101 V (100 Ω)	T
R969	7030003320	S.RESISTOR ERJ3GEYJ 101 V (100 Ω)	B
R970	7030003320	S.RESISTOR ERJ3GEYJ 101 V (100 Ω)	T
R971	7030003320	S.RESISTOR ERJ3GEYJ 101 V (100 Ω)	B
R972	7030003320	S.RESISTOR ERJ3GEYJ 101 V (100 Ω)	T
R973	7030003320	S.RESISTOR ERJ3GEYJ 101 V (100 Ω)	B
R974	7030003320	S.RESISTOR ERJ3GEYJ 101 V (100 Ω)	T
R975	7030003320	S.RESISTOR ERJ3GEYJ 101 V (100 Ω)	B
R976	7030003320	S.RESISTOR ERJ3GEYJ 101 V (100 Ω)	T
R977	7030003320	S.RESISTOR ERJ3GEYJ 101 V (100 Ω)	B
R978	7030003320	S.RESISTOR ERJ3GEYJ 101 V (100 Ω)	T
R979	7030003320	S.RESISTOR ERJ3GEYJ 101 V (100 Ω)	B
C1	4030006880	S.CERAMIC C1608 JB 1H 472K-T	B
C2	4030006880	S.CERAMIC C1608 JB 1H 472K-T	T
C3	4030006880	S.CERAMIC C1608 JB 1H 472K-T	B
C4	4030006880	S.CERAMIC C1608 JB 1H 472K-T	T
C5	4030006880	S.CERAMIC C1608 JB 1H 472K-T	T
C6	4030006880	S.CERAMIC C1608 JB 1H 472K-T	T
C7	4030006880	S.CERAMIC C1608 JB 1H 472K-T	T
C8	4030006880	S.CERAMIC C1608 JB 1H 472K-T	T
C9	4030006880	S.CERAMIC C1608 JB 1H 472K-T	T
C10	4030006880	S.CERAMIC C1608 JB 1H 472K-T	T
C11	4030006880	S.CERAMIC C1608 JB 1H 472K-T	B
C12	4030006880	S.CERAMIC C1608 JB 1H 472K-T	T
C13	4030006880	S.CERAMIC C1608 JB 1H 472K-T	B
C14	4030006880	S.CERAMIC C1608 JB 1H 472K-T	T
C15	4030006880	S.CERAMIC C1608 JB 1H 472K-T	T
C16	4030006880	S.CERAMIC C1608 JB 1H 472K-T	T
C17	4030006880	S.CERAMIC C1608 JB 1H 472K-T	T
C18	4030006880	S.CERAMIC C1608 JB 1H 472K-T	T
C19	4030006880	S.CERAMIC C1608 JB 1H 472K-T	T
C20	4030006880	S.CERAMIC C1608 JB 1H 472K-T	T
C21	4030006880	S.CERAMIC C1608 JB 1H 472K-T	B
C22	4030006880	S.CERAMIC C1608 JB 1H 472K-T	B
C23	4030006880	S.CERAMIC C1608 JB 1H 472K-T	B
C24	4030006880	S.CERAMIC C1608 JB 1H 472K-T	B
C25	4510004630	S.ELECTROLYTIC ECEV1CA100SR	T
C26	4510004630	S.ELECTROLYTIC ECEV1CA100SR	T
C28	4510004630	S.ELECTROLYTIC ECEV1CA100SR	T
C29	4510004630	S.ELECTROLYTIC ECEV1CA100SR	T
C30	4510004630	S.ELECTROLYTIC ECEV1CA100SR	T
C31	4030011600	S.CERAMIC C1608 JB 1E 104K-T	T
C32	4510004630	S.ELECTROLYTIC ECEV1CA100SR	T
C33	4510004630	S.ELECTROLYTIC ECEV1CA100SR	T
C34	4030012600	S.CERAMIC C2012 JB 1A 105M-T	T
C35	4030012600	S.CERAMIC C2012 JB 1A 105M-T	T
C36	4510006220	S.ELECTROLYTIC ECEV1CA101UP	T
C37	4510004630	S.ELECTROLYTIC ECEV1CA100SR	T
C38	4510006220	S.ELECTROLYTIC ECEV1CA101UP	T
C39	4510004630	S.ELECTROLYTIC ECEV1CA100SR	T
C40	4510004630	S.ELECTROLYTIC ECEV1CA100SR	T
C41	4510004630	S.ELECTROLYTIC ECEV1CA100SR	T
C42	4030011600	S.CERAMIC C1608 JB 1E 104K-T	T
C43	4030011600	S.CERAMIC C1608 JB 1E 104K-T	T
C44	4030011600	S.CERAMIC C1608 JB 1E 104K-T	T
C45	4030012600	S.CERAMIC C2012 JB 1A 105M-T	T
C46	4030012600	S.CERAMIC C2012 JB 1A 105M-T	T
C50	4030006880	S.CERAMIC C1608 JB 1H 472K-T	B
C51	4010008590	CERAMIC DD12 63B 472K 500V	T
C52	4030006880	S.CERAMIC C1608 JB 1H 472K-T	B
C53	4030006880	S.CERAMIC C1608 JB 1H 472K-T	B
C54	4030006880	S.CERAMIC C1608 JB 1H 472K-T	B
C55	4030006880	S.CERAMIC C1608 JB 1H 472K-T	B
C56	4030006880	S.CERAMIC C1608 JB 1H 472K-T	B
C57	4030010760	S.CERAMIC C1608 CH 1H 331J-T	T
C58	4030010760	S.CERAMIC C1608 CH 1H 331J-T	T
C61	4030012600	S.CERAMIC C2012 JB 1A 105M-T	T
C62	4030012600	S.CERAMIC C2012 JB 1A 105M-T	B
C65	4030012600	S.CERAMIC C2012 JB 1A 105M-T	T
C68	4030006880	S.CERAMIC C1608 JB 1H 102K-T	B
C69	4030011600	S.CERAMIC C1608 JB 1E 104K-T	T
C70	4030011600	S.CERAMIC C1608 JB 1E 104K-T	B
C71	4030011600	S.CERAMIC C1608 JB 1E 104K-T	B
C100	4030011600	S.CERAMIC C1608 JB 1E 104K-T	B
C101	4030011600	S.CERAMIC C1608 JB 1E 104K-T	T
C103	4510004440	S.ELECTROLYTIC ECEV1HA010SR	T
C105	4030011600	S.CERAMIC C1608 JB 1E 104K-T	B
C106	4030011600	S.CERAMIC C1608 JB 1E 104K-T	T
C108	4510004440	S.ELECTROLYTIC ECEV1HA010SR	T
C110	4510004630	S.ELECTROLYTIC ECEV1CA100SR	T
C113	4510004630	S.ELECTROLYTIC ECEV1CA100SR	T
C115	4510004630	S.ELECTROLYTIC ECEV1CA100SR	T
C116	4510004630	S.ELECTROLYTIC ECEV1CA100SR	T
C117	4510007490	S.ELECTROLYTIC ECEV1VA2R2NR	T

[MAIN UNIT]

REF NO.	ORDER NO.	DESCRIPTION	M.
C118	4510007490	S.ELECTROLYTIC ECEV1VA2R2NR	T
C120	4510004630	S.ELECTROLYTIC ECEV1CA100SR	T
C121	4510004630	S.ELECTROLYTIC ECEV1CA100SR	T
C122	4510004630	S.ELECTROLYTIC ECEV1CA100SR	T
C123	4510004440	S.ELECTROLYTIC ECEV1HA010SR	T
C124	4510004440	S.ELECTROLYTIC ECEV1HA010SR	T
C125	4510004630	S.ELECTROLYTIC ECEV1CA100SR	T
C126	4510004630	S.ELECTROLYTIC ECEV1CA100SR	T
C127	4510004440	S.ELECTROLYTIC ECEV1HA010SR	T
C128	4510004440	S.ELECTROLYTIC ECEV1HA010SR	T
C129	4030008650	S.CERAMIC C1608 JB 1H 332K-T	T
C130	4030008650	S.CERAMIC C1608 JB 1H 332K-T	T
C131	4030012600	S.CERAMIC C2012 JB 1A 105M-T	T
C132	4030012600	S.CERAMIC C2012 JB 1A 105M-T	T
C133	4030008880	S.CERAMIC C1608 JB 1H 223K-T	T
C134	4030008950	S.CERAMIC C2012 JB 1C 823K-T	T
C135	4030008880	S.CERAMIC C1608 JB 1H 223K-T	T
C136	4030008950	S.CERAMIC C2012 JB 1C 823K-T	T
C140	4510004440	S.ELECTROLYTIC ECEV1HA010SR	T
C141	4510008190	ELECTROLYTIC EUUFC1E22S	T
C142	4510005740	S.ELECTROLYTIC ECEV1HAR22SR	T
C143	4510006220	S.ELECTROLYTIC ECEV1CA101UP	T
C144	4510008180	ELECTROLYTIC EUUFC1E102S	T
C145	4510008180	ELECTROLYTIC EUUFC1E102S	T
C146	4030011600	S.CERAMIC C1608 JB 1E 104K-T	B
C147	4030011600	S.CERAMIC C1608 JB 1E 104K-T	B
C148	4030006880	S.CERAMIC C1608 JB 1H 472K-T	B
C149	4030006880	S.CERAMIC C1608 JB 1H 472K-T	B
C150	4030006880	S.CERAMIC C1608 JB 1H 472K-T	B
C151	4030011600	S.CERAMIC C1608 JB 1E 104K-T	T
C152	4030011600	S.CERAMIC C1608 JB 1E 104K-T	T
C180	4510005000	ELECTROLYTIC 16 MV 220 HC	T
C181	4510004630	S.ELECTROLYTIC ECEV1CA100SR	T
C182	4510004630	S.ELECTROLYTIC ECEV1CA100SR	T
C183	4510004630	S.ELECTROLYTIC ECEV1CA100SR	T
C184	4510004630	S.ELECTROLYTIC ECEV1CA100SR	T
C185	4510004630	S.ELECTROLYTIC ECEV1CA100SR	T
C186	4510004630	S.ELECTROLYTIC ECEV1CA100SR	T
C187	4030011600	S.CERAMIC C1608 JB 1E 104K-T	T
C188	4510004630	S.ELECTROLYTIC ECEV1CA100SR	T
C189	4510004630	S.ELECTROLYTIC ECEV1CA100SR	T
C190	4030011340	S.CERAMIC C1608 CH 1H 471J-T	T
C191	4030012610	S.CERAMIC C2012 JB 1C 474K-T	T
C192	4030011340	S.CERAMIC C1608 CH 1H 471J-T	T
C193	4510004630	S.ELECTROLYTIC ECEV1CA100SR	T
C194	4030012600	S.CERAMIC C2012 JB 1A 105M-T	T
C195	4030012600	S.CERAMIC C2012 JB 1A 105M-T	T
C196	4510006220	S.ELECTROLYTIC ECEV1CA101UP	T
C197	4510006220	S.ELECTROLYTIC ECEV1CA101UP	T
C198	4030011600	S.CERAMIC C1608 JB 1E 104K-T	T
C200	4510004630	S.ELECTROLYTIC ECEV1CA100SR	T
C201	4510004630	S.ELECTROLYTIC ECEV1CA100SR	T
C203	4510004440	S.ELECTROLYTIC ECEV1HA010SR	T
C204	4510004440	S.ELECTROLYTIC ECEV1HA010SR	T
C205	4030011600	S.CERAMIC C1608 JB 1E 104K-T	B
C206	4030009970	S.CERAMIC C1608 JB 1H 182K-T	T
C207	4030009970	S.CERAMIC C1608 JB 1H 182K-T	T
C208	4030011600	S.CERAMIC C1608 JB 1E 104K-T	T
C209	4030011600	S.CERAMIC C1608 JB 1E 104K-T	B
C210	4510004440	S.ELECTROLYTIC ECEV1HA010SR	T
C211	4510004630	S.ELECTROLYTIC ECEV1CA100SR	T
C212	4510005860	S.ELECTROLYTIC ECEV1HA2R2SR	T
C213	4030017840	S.CERAMIC C2012 CH 1H 222J-T	T
C214	4510004630	S.ELECTROLYTIC ECEV1CA100SR	T
C215	4510004440	S.ELECTROLYTIC ECEV1HA010SR	T
C216	4510004440	S.ELECTROLYTIC ECEV1HA010SR	T
C217	4030007120	S.CERAMIC C1608 CH 1H 820J-T	T
C220	4510004440	S.ELECTROLYTIC ECEV1HA010SR	T
C221	4510004630	S.ELECTROLYTIC ECEV1CA100SR	T
C222	4510005860	S.ELECTROLYTIC ECEV1HA2R2SR	T
C223	4030017840	S.CERAMIC C2012 CH 1H 222J-T	T
C225	4510004440	S.ELECTROLYTIC ECEV1HA010SR	T
C226	4510004440	S.ELECTROLYTIC ECEV1HA010SR	T
C230	4510006220	S.ELECTROLYTIC ECEV1CA101UP	T
C231	4510006220	S.ELECTROLYTIC ECEV1CA101UP	T
C233	4510004440	S.ELECTROLYTIC ECEV1HA010SR	T
C234	4030007170	S.CERAMIC C1608 CH 1H 221J-T	T
C235	4030011600	S.CERAMIC C1608 JB 1E 104K-T	T
C241	4510004630	S.ELECTROLYTIC ECEV1CA100SR	T
C242	4510004590	ELECTROLYTIC 16 MV 470 HC	T
C243	4510006220	S.ELECTROLYTIC ECEV1CA101UP	T
C244	4030011600	S.CERAMIC C1608 JB 1E 104K-T	T
C249	4030011600	S.CERAMIC C1608 JB 1E 104K-T	T
C250	4030011600	S.CERAMIC C1608 JB 1E 104K-T	T
C251	4030011600	S.CERAMIC C1608 JB 1E 104K-T	T
C260	4030011600	S.CERAMIC C1608 JB 1E 104K-T	T
C261	4030011600	S.CERAMIC C1608 JB 1E 104K-T	T
C290	4030011600	S.CERAMIC C1608 JB 1E 104K-T	T

M.=Mounted side (T: Mounted on the Top side, B: Mounted on the Bottom side)

S.=Surface mount

[MAIN UNIT]

REF NO.	ORDER NO.	DESCRIPTION	M.
C291	4030011600	S.CERAMIC C1608 JB 1E 104K-T	T
C310	4030011600	S.CERAMIC C1608 JB 1E 104K-T	T
C311	4030011600	S.CERAMIC C1608 JB 1E 104K-T	T
C330	4030011600	S.CERAMIC C1608 JB 1E 104K-T	T
C331	4030011600	S.CERAMIC C1608 JB 1E 104K-T	T
C332	4030011600	S.CERAMIC C1608 JB 1E 104K-T	T
C333	4030011600	S.CERAMIC C1608 JB 1E 104K-T	T
C340	4030017810	S.CERAMIC C1608 CH 1H 102J-T	B
C341	4030017810	S.CERAMIC C1608 CH 1H 102J-T	B
C342	4030011600	S.CERAMIC C1608 JB 1E 104K-T	B
C360	4030017810	S.CERAMIC C1608 CH 1H 102J-T	B
C361	4030017810	S.CERAMIC C1608 CH 1H 102J-T	B
C362	4030011600	S.CERAMIC C1608 JB 1E 104K-T	B
C380	4030017810	S.CERAMIC C1608 CH 1H 102J-T	B
C381	4030017810	S.CERAMIC C1608 CH 1H 102J-T	B
C400	4030006880	S.CERAMIC C1608 JB 1H 472K-T	B
C401	4030006880	S.CERAMIC C1608 JB 1H 472K-T	B
C402	4030006880	S.CERAMIC C1608 JB 1H 472K-T	B
C403	4030006880	S.CERAMIC C1608 JB 1H 472K-T	B
C404	4030006880	S.CERAMIC C1608 JB 1H 472K-T	T
C405	4030006880	S.CERAMIC C1608 JB 1H 472K-T	T
C406	4030006880	S.CERAMIC C1608 JB 1H 472K-T	T
C407	4030006880	S.CERAMIC C1608 JB 1H 472K-T	T
C408	4030006880	S.CERAMIC C1608 JB 1H 472K-T	T
C409	4030006880	S.CERAMIC C1608 JB 1H 472K-T	T
C410	4030006880	S.CERAMIC C1608 JB 1H 472K-T	T
C411	4030006880	S.CERAMIC C1608 JB 1H 472K-T	B
C412	4030006880	S.CERAMIC C1608 JB 1H 472K-T	B
C413	4030006880	S.CERAMIC C1608 JB 1H 472K-T	B
C414	4030006880	S.CERAMIC C1608 JB 1H 472K-T	B
C415	4030006880	S.CERAMIC C1608 JB 1H 472K-T	T
C416	4030006880	S.CERAMIC C1608 JB 1H 472K-T	B
C418	4030006880	S.CERAMIC C1608 JB 1H 472K-T	B
C430	4030006880	S.CERAMIC C1608 JB 1H 472K-T	B
C431	4030006880	S.CERAMIC C1608 JB 1H 472K-T	B
C432	4030006880	S.CERAMIC C1608 JB 1H 472K-T	B
C435	4030006880	S.CERAMIC C1608 JB 1H 472K-T	B
C440	4030006880	S.CERAMIC C1608 JB 1H 472K-T	B
C441	4030006880	S.CERAMIC C1608 JB 1H 472K-T	B
C442	4030006880	S.CERAMIC C1608 JB 1H 472K-T	T
C450	4030006880	S.CERAMIC C1608 JB 1H 472K-T	T
C451	4030006880	S.CERAMIC C1608 JB 1H 472K-T	B
C452	4030006880	S.CERAMIC C1608 JB 1H 472K-T	B
C453	4030006880	S.CERAMIC C1608 JB 1H 472K-T	B
C454	4030006880	S.CERAMIC C1608 JB 1H 472K-T	B
C455	4030006880	S.CERAMIC C1608 JB 1H 472K-T	B
C456	4030006880	S.CERAMIC C1608 JB 1H 472K-T	B
C460	4510004440	S.ELECTROLYTIC ECEV1HA010SR	T
C461	4510004440	S.ELECTROLYTIC ECEV1HA010SR	T
C464	4510004630	S.ELECTROLYTIC ECEV1CA100SR	T
C465	4030011600	S.CERAMIC C1608 JB 1E 104K-T	B
C466	4030011600	S.CERAMIC C1608 JB 1E 104K-T	B
C467	4030012600	S.CERAMIC C2012 JB 1A 105M-T	T
C469	4510004440	S.ELECTROLYTIC ECEV1HA010SR	T
C470	4510004440	S.ELECTROLYTIC ECEV1HA010SR	T
C480	4550006620	S.TANTALUM ECST0JY226R	B
C481	4550006620	S.TANTALUM ECST0JY226R	B
C483	4550006620	S.TANTALUM ECST0JY226R	B
C484	4550006620	S.TANTALUM ECST0JY226R	B
C486	4550006620	S.TANTALUM ECST0JY226R	B
C487	4550006620	S.TANTALUM ECST0JY226R	B
C489	4030011600	S.CERAMIC C1608 JB 1E 104K-T	B
C490	4030011600	S.CERAMIC C1608 JB 1E 104K-T	B
C491	4030011600	S.CERAMIC C1608 JB 1E 104K-T	B
C492	4030006880	S.CERAMIC C1608 JB 1H 472K-T	T
C493	4510004630	S.ELECTROLYTIC ECEV1CA100SR	T
C494	4510004590	ELECTROLYTIC 16 MV 470 HC	T
C495	4030011600	S.CERAMIC C1608 JB 1E 104K-T	B
C496	4030011600	S.CERAMIC C1608 JB 1E 104K-T	B
C497	4030011600	S.CERAMIC C1608 JB 1E 104K-T	B
C498	4510004590	ELECTROLYTIC 16 MV 470 HC	T
C499	4030011600	S.CERAMIC C1608 JB 1E 104K-T	T
C501	4030011600	S.CERAMIC C1608 JB 1E 104K-T	T
C502	4030010020	S.CERAMIC C1608 JB 1H 122K-T	T
C503	4030009980	S.CERAMIC C1608 JB 1H 152K-T	T
C505	4030011330	S.CERAMIC C1608 CH 1H 391J-T	T
C506	4030011600	S.CERAMIC C1608 JB 1E 104K-T	T
C507	4510004630	S.ELECTROLYTIC ECEV1CA100SR	T
C508	4510004630	S.ELECTROLYTIC ECEV1CA100SR	T
C509	4030011600	S.CERAMIC C1608 JB 1E 104K-T	T
C510	4030008470	S.CERAMIC C1608 JB 1H 272K-T	T
C511	4030011280	S.CERAMIC C1608 CH 1H 271J-T	T
C512	4030011600	S.CERAMIC C1608 JB 1E 104K-T	T
C513	4510004630	S.ELECTROLYTIC ECEV1CA100SR	T
C514	4030011600	S.CERAMIC C1608 JB 1E 104K-T	T
C515	4510004630	S.ELECTROLYTIC ECEV1CA100SR	T
C516	4030006860	S.CERAMIC C1608 JB 1H 102K-T	T
C517	4030011600	S.CERAMIC C1608 JB 1E 104K-T	T

[MAIN UNIT]

REF NO.	ORDER NO.	DESCRIPTION	M.
C518	4030011600	S.CERAMIC C1608 JB 1E 104K-T	T
C519	4030011600	S.CERAMIC C1608 JB 1E 104K-T	T
C520	4510004630	S.ELECTROLYTIC ECEV1CA100SR	T
C521	4030011600	S.CERAMIC C1608 JB 1E 104K-T	T
C522	4030011600	S.CERAMIC C1608 JB 1E 104K-T	B
C523	4030011600	S.CERAMIC C1608 JB 1E 104K-T	B
C524	4510004630	S.ELECTROLYTIC ECEV1CA100SR	T
C525	4030006880	S.CERAMIC C1608 JB 1H 472K-T	T
C526	4030011600	S.CERAMIC C1608 JB 1E 104K-T	B
C527	4030006880	S.CERAMIC C1608 JB 1H 472K-T	B
C528	4030011600	S.CERAMIC C1608 JB 1E 104K-T	B
C529	4030011600	S.CERAMIC C1608 JB 1E 104K-T	B
C530	4030011600	S.CERAMIC C1608 JB 1E 104K-T	B
C531	4030006880	S.CERAMIC C1608 JB 1H 472K-T	B
C532	4030006880	S.CERAMIC C1608 JB 1H 472K-T	B
C533	4030006880	S.CERAMIC C1608 JB 1H 472K-T	B
C534	4030006880	S.CERAMIC C1608 JB 1H 472K-T	B
C535	4030006880	S.CERAMIC C1608 JB 1H 472K-T	B
C536	4030011600	S.CERAMIC C1608 JB 1E 104K-T	B
C537	4030006880	S.CERAMIC C1608 JB 1H 472K-T	B
C538	4030008920	S.CERAMIC C1608 JB 1H 473K-T	T
C539	4030011600	S.CERAMIC C1608 JB 1E 104K-T	B
C540	4510004630	S.ELECTROLYTIC ECEV1CA100SR	T
C541	4030011600	S.CERAMIC C1608 JB 1E 104K-T	B
C544	4030009530	S.CERAMIC C1608 CH 1H 030B-T	T
C545	4030011600	S.CERAMIC C1608 JB 1E 104K-T	T
C546	4030011340	S.CERAMIC C1608 CH 1H 471J-T	T
C548	4030011600	S.CERAMIC C1608 JB 1E 104K-T	B
C550	4510004630	S.ELECTROLYTIC ECEV1CA100SR	T
C551	4030006880	S.CERAMIC C1608 JB 1H 472K-T	B
C552	4030006860	S.CERAMIC C1608 JB 1H 102K-T	B
C553	4030011770	S.CERAMIC C1608 CH 1H 060B-T	B
C554	4030011600	S.CERAMIC C1608 JB 1E 104K-T	B
C555	4030007030	S.CERAMIC C1608 CH 1H 150J-T	B
C556	4030006880	S.CERAMIC C1608 JB 1H 472K-T	B
C558	4030007040	S.CERAMIC C1608 CH 1H 180J-T	T
C559	4030006880	S.CERAMIC C1608 JB 1H 472K-T	T
C560	4030007080	S.CERAMIC C1608 CH 1H 390J-T	T
C561	4030006880	S.CERAMIC C1608 JB 1H 472K-T	T
C562	4030006860	S.CERAMIC C1608 JB 1H 102K-T	B
C563	4030011600	S.CERAMIC C1608 JB 1E 104K-T	T
C564	4030007080	S.CERAMIC C1608 CH 1H 390J-T	T
C565	4030007130	S.CERAMIC C1608 CH 1H 101J-T	B
C566	4030007120	S.CERAMIC C1608 CH 1H 820J-T	B
C567	4030007090	S.CERAMIC C1608 CH 1H 470J-T	B
C568	4030007130	S.CERAMIC C1608 CH 1H 101J-T	B
C569	4030011600	S.CERAMIC C1608 JB 1E 104K-T	B
C570	4030006900	S.CERAMIC C1608 JB 1H 103K-T	B
C571	4030011600	S.CERAMIC C1608 JB 1E 104K-T	B
C572	4030006900	S.CERAMIC C1608 JB 1H 103K-T	B
C573	4030011600	S.CERAMIC C1608 JB 1E 104K-T	B
C574	4030011600	S.CERAMIC C1608 JB 1E 104K-T	B
C576	4610001590	S.CERAMIC TZC3R100A110R00	T
C577	4030011600	S.CERAMIC C1608 JB 1E 104K-T	B
C578	4030007100	S.CERAMIC C1608 CH 1H 560J-T	B
C579	4030006980	S.CERAMIC C1608 CH 1H 070D-T	B
C580	4030007100	S.CERAMIC C1608 CH 1H 560J-T	B
C581	4030007050	S.CERAMIC C1608 CH 1H 220J-T	T
C582	4030007050	S.CERAMIC C1608 CH 1H 220J-T	T
C583	4030011600	S.CERAMIC C1608 JB 1E 104K-T	T
C584	4030009650	S.CERAMIC C1608 CH 1H 240J-T	B
C585	4030006980	S.CERAMIC C1608 CH 1H 070D-T	B
C586	4030007070	S.CERAMIC C1608 CH 1H 330J-T	B
C587	4030007010	S.CERAMIC C1608 CH 1H 100D-T	B
C588	4030007060	S.CERAMIC C1608 CH 1H 270J-T	B
C589	4030007020	S.CERAMIC C1608 CH 1H 120J-T	B
C590	4030007100	S.CERAMIC C1608 CH 1H 560J-T	B
C591	4030007090	S.CERAMIC C1608 CH 1H 470J-T	T
C593	4030009530	S.CERAMIC C1608 CH 1H 030B-T	T
C601	4030006860	S.CERAMIC C1608 JB 1H 102K-T	B
C602	4030006860	S.CERAMIC C1608 JB 1H 102K-T	B
C603	4030011600	S.CERAMIC C1608 JB 1E 104K-T	T
C604	4030007140	S.CERAMIC C1608 CH 1H 121J-T	B
C605	4030010760	S.CERAMIC C1608 CH 1H 331J-T	B
C606	4030007160	S.CERAMIC C1608 CH 1H 181J-T	B
C607	4030007060	S.CERAMIC C1608 CH 1H 270J-T	B
C608	4030010760	S.CERAMIC C1608 CH 1H 331J-T	B
C609	4030007090	S.CERAMIC C1608 CH 1H 470J-T	B
C610	4030007160	S.CERAMIC C1608 CH 1H 181J-T	B
C611	4030007060	S.CERAMIC C1608 CH 1H 270J-T	B
C612	4030007140	S.CERAMIC C1608 CH 1H 121J-T	B
C613	4030010760	S.CERAMIC C1608 CH 1H 331J-T	B
C614	4030006860	S.CERAMIC C1608 JB 1H 102K-T	B
C615	4030011600	S.CERAMIC C1608 JB 1E 104K-T	B
C616	4030006860	S.CERAMIC C1608 JB 1H 102K-T	B
C617	4030010040	S.CERAMIC C1608 JB 1H 561K-T	B
C618	4030010760	S.CERAMIC C1608 CH 1H 331J-T	B
C619	4030011600	S.CERAMIC C1608 JB 1E 104K-T	B

M.-Mounted side (T: Mounted on the Top side, B: Mounted on the Bottom side)

S.-Surface mount

[MAIN UNIT]

REF NO.	ORDER NO.	DESCRIPTION	M.
C620	4030010760	S.CERAMIC C1608 CH 1H 331J-T	B
C621	4030007080	S.CERAMIC C1608 CH 1H 390J-T	B
C622	4030007080	S.CERAMIC C1608 CH 1H 390J-T	B
C623	4030010760	S.CERAMIC C1608 CH 1H 331J-T	B
C624	4030007090	S.CERAMIC C1608 CH 1H 470J-T	B
C625	4030010760	S.CERAMIC C1608 CH 1H 331J-T	B
C626	4030007080	S.CERAMIC C1608 CH 1H 390J-T	B
C627	4030010760	S.CERAMIC C1608 CH 1H 331J-T	B
C628	4030007080	S.CERAMIC C1608 CH 1H 390J-T	B
C629	4030010760	S.CERAMIC C1608 CH 1H 331J-T	B
C630	4030010760	S.CERAMIC C1608 CH 1H 331J-T	B
C631	4030011600	S.CERAMIC C1608 JB 1E 104K-T	B
C632	4030010040	S.CERAMIC C1608 JB 1H 561K-T	B
C633	4030010040	S.CERAMIC C1608 JB 1H 561K-T	B
C634	4030011330	S.CERAMIC C1608 CH 1H 391J-T	B
C635	4030011600	S.CERAMIC C1608 JB 1E 104K-T	B
C636	4030007160	S.CERAMIC C1608 CH 1H 181J-T	B
C637	4030007070	S.CERAMIC C1608 CH 1H 330J-T	B
C638	4030007030	S.CERAMIC C1608 CH 1H 150J-T	B
C639	4030007120	S.CERAMIC C1608 CH 1H 820J-T	B
C640	4030007100	S.CERAMIC C1608 CH 1H 560J-T	B
C641	4030007140	S.CERAMIC C1608 CH 1H 121J-T	B
C642	4030007030	S.CERAMIC C1608 CH 1H 150J-T	B
C643	4030007120	S.CERAMIC C1608 CH 1H 820J-T	B
C644	4030007070	S.CERAMIC C1608 CH 1H 330J-T	B
C645	4030007160	S.CERAMIC C1608 CH 1H 181J-T	B
C646	4030011330	S.CERAMIC C1608 CH 1H 391J-T	B
C647	4030011600	S.CERAMIC C1608 JB 1E 104K-T	B
C648	4030017800	S.CERAMIC C1608 CH 1H 561J-T	B
C649	4030010760	S.CERAMIC C1608 CH 1H 331J-T	B
C650	4030007150	S.CERAMIC C1608 CH 1H 151J-T	B
C651	4030011600	S.CERAMIC C1608 JB 1E 104K-T	B
C652	4030007150	S.CERAMIC C1608 CH 1H 151J-T	B
C653	4030007060	S.CERAMIC C1608 CH 1H 270J-T	B
C654	4030007060	S.CERAMIC C1608 CH 1H 270J-T	B
C655	4030007140	S.CERAMIC C1608 CH 1H 121J-T	B
C656	4030007010	S.CERAMIC C1608 CH 1H 100D-T	B
C657	4030007150	S.CERAMIC C1608 CH 1H 151J-T	B
C658	4030007060	S.CERAMIC C1608 CH 1H 270J-T	B
C659	4030007140	S.CERAMIC C1608 CH 1H 121J-T	B
C660	4030007060	S.CERAMIC C1608 CH 1H 270J-T	B
C661	4030007150	S.CERAMIC C1608 CH 1H 151J-T	B
C662	4030007150	S.CERAMIC C1608 CH 1H 151J-T	B
C663	4030011600	S.CERAMIC C1608 JB 1E 104K-T	B
C664	4030010760	S.CERAMIC C1608 CH 1H 331J-T	B
C665	4030007170	S.CERAMIC C1608 CH 1H 221J-T	B
C666	4030007170	S.CERAMIC C1608 CH 1H 221J-T	B
C667	4030011600	S.CERAMIC C1608 JB 1E 104K-T	B
C668	4030007130	S.CERAMIC C1608 CH 1H 101J-T	B
C669	4030007050	S.CERAMIC C1608 CH 1H 220J-T	B
C670	4030007080	S.CERAMIC C1608 CH 1H 390J-T	B
C671	4030007070	S.CERAMIC C1608 CH 1H 330J-T	B
C672	4030007050	S.CERAMIC C1608 CH 1H 220J-T	B
C673	4030007120	S.CERAMIC C1608 CH 1H 820J-T	B
C674	4030007080	S.CERAMIC C1608 CH 1H 390J-T	B
C675	4030007070	S.CERAMIC C1608 CH 1H 330J-T	B
C676	4030007050	S.CERAMIC C1608 CH 1H 220J-T	B
C677	4030007130	S.CERAMIC C1608 CH 1H 101J-T	B
C678	4030007170	S.CERAMIC C1608 CH 1H 221J-T	B
C679	4030011600	S.CERAMIC C1608 JB 1E 104K-T	B
C680	4030007170	S.CERAMIC C1608 CH 1H 221J-T	B
C681	4030007170	S.CERAMIC C1608 CH 1H 221J-T	T
C682	4030007110	S.CERAMIC C1608 CH 1H 680J-T	T
C683	4030011600	S.CERAMIC C1608 JB 1E 104K-T	T
C684	4030007090	S.CERAMIC C1608 CH 1H 470J-T	T
C685	4030007090	S.CERAMIC C1608 CH 1H 470J-T	T
C686	4030007070	S.CERAMIC C1608 CH 1H 330J-T	T
C687	4030007070	S.CERAMIC C1608 CH 1H 330J-T	T
C688	4030007010	S.CERAMIC C1608 CH 1H 100D-T	T
C689	4030007120	S.CERAMIC C1608 CH 1H 820J-T	T
C690	4030007070	S.CERAMIC C1608 CH 1H 330J-T	T
C691	4030007070	S.CERAMIC C1608 CH 1H 330J-T	T
C692	4030007090	S.CERAMIC C1608 CH 1H 470J-T	T
C693	4030007090	S.CERAMIC C1608 CH 1H 470J-T	T
C694	4030007110	S.CERAMIC C1608 CH 1H 680J-T	T
C695	4030011600	S.CERAMIC C1608 JB 1E 104K-T	T
C696	4030007050	S.CERAMIC C1608 CH 1H 220J-T	T
C697	4030007160	S.CERAMIC C1608 CH 1H 181J-T	T
C698	4030007090	S.CERAMIC C1608 CH 1H 470J-T	T
C699	4030011600	S.CERAMIC C1608 JB 1E 104K-T	T
C700	4030007090	S.CERAMIC C1608 CH 1H 470J-T	T
C701	4030007040	S.CERAMIC C1608 CH 1H 180J-T	T
C702	4030007030	S.CERAMIC C1608 CH 1H 150J-T	T
C703	4030007050	S.CERAMIC C1608 CH 1H 220J-T	T
C704	4030006990	S.CERAMIC C1608 CH 1H 080D-T	T
C705	4030007090	S.CERAMIC C1608 CH 1H 470J-T	T
C706	4030007030	S.CERAMIC C1608 CH 1H 150J-T	T
C707	4030007050	S.CERAMIC C1608 CH 1H 220J-T	T

[MAIN UNIT]

REF NO.	ORDER NO.	DESCRIPTION	M.
C708	4030007040	S.CERAMIC C1608 CH 1H 180J-T	T
C709	4030007090	S.CERAMIC C1608 CH 1H 470J-T	T
C710	4030007090	S.CERAMIC C1608 CH 1H 470J-T	T
C711	4030011600	S.CERAMIC C1608 JB 1E 104K-T	T
C712	4030007160	S.CERAMIC C1608 CH 1H 181J-T	T
C713	4030007140	S.CERAMIC C1608 CH 1H 121J-T	T
C714	4030007040	S.CERAMIC C1608 CH 1H 180J-T	T
C715	4030011600	S.CERAMIC C1608 JB 1E 104K-T	T
C716	4030007070	S.CERAMIC C1608 CH 1H 330J-T	T
C717	4030007040	S.CERAMIC C1608 CH 1H 180J-T	T
C718	4030007010	S.CERAMIC C1608 CH 1H 100D-T	T
C719	4030007070	S.CERAMIC C1608 CH 1H 330J-T	T
C720	4030007010	S.CERAMIC C1608 CH 1H 100D-T	T
C721	4030007090	S.CERAMIC C1608 CH 1H 470J-T	T
C722	4030007010	S.CERAMIC C1608 CH 1H 100D-T	T
C723	4030007070	S.CERAMIC C1608 CH 1H 330J-T	T
C724	4030007040	S.CERAMIC C1608 CH 1H 180J-T	T
C725	4030007070	S.CERAMIC C1608 CH 1H 330J-T	T
C726	4030007040	S.CERAMIC C1608 CH 1H 180J-T	T
C727	4030011600	S.CERAMIC C1608 JB 1E 104K-T	T
C728	4030007140	S.CERAMIC C1608 CH 1H 121J-T	T
C729	4030007130	S.CERAMIC C1608 CH 1H 101J-T	T
C730	4030007030	S.CERAMIC C1608 CH 1H 150J-T	T
C731	4030011600	S.CERAMIC C1608 JB 1E 104K-T	T
C732	4030007050	S.CERAMIC C1608 CH 1H 220J-T	T
C733	4030007020	S.CERAMIC C1608 CH 1H 120J-T	T
C734	4030009500	S.CERAMIC C1608 CH 1H 0R5B-T	T
C735	4030007050	S.CERAMIC C1608 CH 1H 220J-T	T
C736	4030006980	S.CERAMIC C1608 CH 1H 070D-T	T
C737	4030007050	S.CERAMIC C1608 CH 1H 220J-T	T
C738	4030009500	S.CERAMIC C1608 CH 1H 0R5B-T	T
C739	4030007050	S.CERAMIC C1608 CH 1H 220J-T	T
C740	4030007020	S.CERAMIC C1608 CH 1H 120J-T	T
C741	4030007050	S.CERAMIC C1608 CH 1H 220J-T	T
C742	4030007030	S.CERAMIC C1608 CH 1H 150J-T	T
C743	4030011600	S.CERAMIC C1608 JB 1E 104K-T	T
C744	4030007130	S.CERAMIC C1608 CH 1H 101J-T	T
C745	4030007140	S.CERAMIC C1608 CH 1H 121J-T	T
C747	4030011600	S.CERAMIC C1608 JB 1E 104K-T	T
C749	4030009550	S.CERAMIC C1608 CH 1H 2R5B-T	T
C750	4030011770	S.CERAMIC C1608 CH 1H 060B-T	T
C751	4030007010	S.CERAMIC C1608 CH 1H 100D-T	T
C755	4030009550	S.CERAMIC C1608 CH 1H 2R5B-T	T
C756	4030011770	S.CERAMIC C1608 CH 1H 060B-T	T
C758	4030011600	S.CERAMIC C1608 JB 1E 104K-T	T
C759	4030007140	S.CERAMIC C1608 CH 1H 121J-T	T
C760	4030011770	S.CERAMIC C1608 CH 1H 060B-T	T
C761	4030011770	S.CERAMIC C1608 CH 1H 060B-T	T
C801	4030006880	S.CERAMIC C1608 JB 1H 472K-T	T
C802	4030011600	S.CERAMIC C1608 JB 1E 104K-T	T
C803	4030011600	S.CERAMIC C1608 JB 1E 104K-T	B
C804	4030011600	S.CERAMIC C1608 JB 1E 104K-T	T
C805	4030011600	S.CERAMIC C1608 JB 1E 104K-T	B
C806	4030006900	S.CERAMIC C1608 JB 1H 103K-T	B
C807	4030011600	S.CERAMIC C1608 JB 1E 104K-T	T
C812	4030006900	S.CERAMIC C1608 JB 1H 103K-T	B
C813	4030006880	S.CERAMIC C1608 JB 1H 472K-T	T
C814	4030012600	S.CERAMIC C2012 JB 1A 105M-T	T
C815	4030006990	S.CERAMIC C1608 CH 1H 080D-T	B
C820	4030011600	S.CERAMIC C1608 JB 1E 104K-T	T
C821	4030011600	S.CERAMIC C1608 JB 1E 104K-T	T
C822	4030011600	S.CERAMIC C1608 JB 1E 104K-T	T
C823	4030012600	S.CERAMIC C2012 JB 1A 105M-T	T
C824	4030006900	S.CERAMIC C1608 JB 1H 103K-T	T
C825	4030008880	S.CERAMIC C1608 JB 1H 223K-T	T
C826	4030008850	S.CERAMIC C1608 JB 1H 123K-T	T
C827	4030008850	S.CERAMIC C1608 JB 1H 123K-T	T
C828	4030006900	S.CERAMIC C1608 JB 1H 103K-T	T
C829	4030008860	S.CERAMIC C1608 JB 1H 153K-T	T
C830	4030008860	S.CERAMIC C1608 JB 1H 153K-T	T
C831	4030008650	S.CERAMIC C1608 JB 1H 332K-T	T
C832	4030006900	S.CERAMIC C1608 JB 1H 103K-T	T
C833	4030006900	S.CERAMIC C1608 JB 1H 103K-T	T
C834	4030012600	S.CERAMIC C2012 JB 1A 105M-T	T
C835	4030011600	S.CERAMIC C1608 JB 1E 104K-T	T
C836	4030009920	S.CERAMIC C1608 CH 1H 050B-T	T
C839	4030006880	S.CERAMIC C1608 JB 1H 472K-T	B
C840	4030011600	S.CERAMIC C1608 JB 1E 104K-T	B
C841	4030006880	S.CERAMIC C1608 JB 1H 472K-T	B
C845	4030011600	S.CERAMIC C1608 JB 1E 104K-T	T
C846	4030011600	S.CERAMIC C1608 JB 1E 104K-T	T
C847	4510004630	S.ELECTROLYTIC ECEV1CA100SR	T
C901	4030006880	S.CERAMIC C1608 JB 1H 472K-T	B
C902	4030006880	S.CERAMIC C1608 JB 1H 472K-T	T
C903	4030006880	S.CERAMIC C1608 JB 1H 472K-T	B
C904	4030006880	S.CERAMIC C1608 JB 1H 472K-T	T
C905	4030006880	S.CERAMIC C1608 JB 1H 472K-T	B
C906	4030006880	S.CERAMIC C1608 JB 1H 472K-T	T

M.=Mounted side (T: Mounted on the Top side, B: Mounted on the Bottom side)

S.=Surface mount

[MAIN UNIT]

REF NO.	ORDER NO.	DESCRIPTION		M.
C907	4030006880	S.CERAMIC	C1608 JB 1H 472K-T	B
C908	4030006880	S.CERAMIC	C1608 JB 1H 472K-T	T
C909	4030006880	S.CERAMIC	C1608 JB 1H 472K-T	B
C922	4030006880	S.CERAMIC	C1608 JB 1H 472K-T	T
C923	4030006880	S.CERAMIC	C1608 JB 1H 472K-T	B
C924	4030006880	S.CERAMIC	C1608 JB 1H 472K-T	T
C925	4030006880	S.CERAMIC	C1608 JB 1H 472K-T	B
C926	4030006880	S.CERAMIC	C1608 JB 1H 472K-T	T
C927	4030006880	S.CERAMIC	C1608 JB 1H 472K-T	B
C928	4030006880	S.CERAMIC	C1608 JB 1H 472K-T	T
C929	4030006880	S.CERAMIC	C1608 JB 1H 472K-T	B
C930	4030006880	S.CERAMIC	C1608 JB 1H 472K-T	T
C932	4030006880	S.CERAMIC	C1608 JB 1H 472K-T	B
C933	4030006880	S.CERAMIC	C1608 JB 1H 472K-T	T
C934	4030006880	S.CERAMIC	C1608 JB 1H 472K-T	B
C936	4030006880	S.CERAMIC	C1608 JB 1H 472K-T	T
C937	4030006880	S.CERAMIC	C1608 JB 1H 472K-T	B
C945	4030006880	S.CERAMIC	C1608 JB 1H 472K-T	T
C946	4030006880	S.CERAMIC	C1608 JB 1H 472K-T	B
C947	4030006880	S.CERAMIC	C1608 JB 1H 472K-T	T
C948	4030006880	S.CERAMIC	C1608 JB 1H 472K-T	B
C952	4030006880	S.CERAMIC	C1608 JB 1H 472K-T	T
C953	4030006880	S.CERAMIC	C1608 JB 1H 472K-T	B
C954	4030006880	S.CERAMIC	C1608 JB 1H 472K-T	T
C955	4030006880	S.CERAMIC	C1608 JB 1H 472K-T	B
C957	4030006880	S.CERAMIC	C1608 JB 1H 472K-T	T
C958	4030006880	S.CERAMIC	C1608 JB 1H 472K-T	B
C974	4030006880	S.CERAMIC	C1608 JB 1H 472K-T	T
C975	4030006880	S.CERAMIC	C1608 JB 1H 472K-T	B
C976	4030006880	S.CERAMIC	C1608 JB 1H 472K-T	T
C977	4030006880	S.CERAMIC	C1608 JB 1H 472K-T	B
C978	4030006880	S.CERAMIC	C1608 JB 1H 472K-T	T
C979	4030006880	S.CERAMIC	C1608 JB 1H 472K-T	B
C980	4030006880	S.CERAMIC	C1608 JB 1H 472K-T	T
C981	4030006880	S.CERAMIC	C1608 JB 1H 472K-T	B
RL50	6330000540	RELAY	OMR-109F	T
RL140	6330001430	RELAY	NA-12W-K	T
RL141	6330001430	RELAY	NA-12W-K	T
CP81	6910009670	S.CHECK P	HK3-S-T	T
CP82	6910009670	S.CHECK P	HK3-S-T	T
CP495	6910009670	S.CHECK P	HK3-S-T	T
CP496	6910009670	S.CHECK P	HK3-S-T	T
J1	6510023670	CONNECTOR	TCS4480-01-4151	T
J2	6510023660	CONNECTOR	TCS4470-01-4151	T
J3	6510023670	CONNECTOR	TCS4480-01-4151	T
J4	6510023660	CONNECTOR	TCS4470-01-4151	T
J5	6450001130	CONNECTOR	JPJ2042-01-110	T
J6	6510023730	CONNECTOR	LGY6502-0600C	T
J7	6510023730	CONNECTOR	LGY6502-0600C	T
J8	6510023740	CONNECTOR	LGR4609-7000	T
J9	6510023070	CONNECTOR	HEC2305-01-250	T
J140	6510023720	CONNECTOR	LGY6501-0600C	T
J141	6510023720	CONNECTOR	LGY6501-0600C	T
J142	6510018960	S.CONNECTOR	B2B-PH-SM3-TB	T
J340	6510022810	CONNECTOR	IMSA-9180B-22B	T
J341	6510021650	CONNECTOR	IMSA-9180B-30B	T
J360	6510022810	CONNECTOR	IMSA-9180B-22B	T
J361	6510021650	CONNECTOR	IMSA-9180B-30B	T
J380	6510022810	CONNECTOR	IMSA-9180B-22B	T
J381	6510021650	CONNECTOR	IMSA-9180B-30B	T
J399	6510007020	CONNECTOR	TMP-J01X-V6	T
J400	6510019980	S.CONNECTOR	52808-1691	T
J401	6510022190	S.CONNECTOR	B3B-PH-SM3-TB	T
J403	6510019980	S.CONNECTOR	52808-1691	T
J404	6510022190	S.CONNECTOR	B3B-PH-SM3-TB	T
J410	6510020000	S.CONNECTOR	52808-3091	T
J411	6510019970	S.CONNECTOR	52808-1091	T
J430	6510022310	S.CONNECTOR	B5B-PH-SM3-TB	T
J440	6510018920	S.CONNECTOR	B8B-PH-SM3-TB	T
J450	6510003470	CONNECTOR	B11B-EH-S	T
J451	6510018940	S.CONNECTOR	B13B-PH-SM3-TB	T
J490	6510023750	CONNECTOR	01K1971-10	T
J491	6510007020	CONNECTOR	TMP-J01X-V6	T
J492	6510014960	S.CONNECTOR	B2B-ZR-SM3-TF	T
J495	6510023700	CONNECTOR	TORX178S	T
J496	6510023710	CONNECTOR	TOTX178S	T
J501	6510007020	CONNECTOR	TMP-J01X-V6	T
J502	6510007020	CONNECTOR	TMP-J01X-V6	T
J503	6510007020	CONNECTOR	TMP-J01X-V6	T
J801	6510007020	CONNECTOR	TMP-J01X-V6	T
J802	6510007020	CONNECTOR	TMP-J01X-V6	T
J808	6510007020	CONNECTOR	TMP-J01X-V6	T

M.=Mounted side (T: Mounted on the Top side, B: Mounted on the Bottom side)

[MAIN UNIT]

REF NO.	ORDER NO.	DESCRIPTION		M.
J900	6510022470	S.CONNECTOR	40FLT-SM1-TB	T
J901	6510015540	S.CONNECTOR	B4B-ZR-SM3-TF	T
J940	6510022470	S.CONNECTOR	40FLT-SM1-TB	T
F1	5220000230	HOLDER	S-N5054	T
F2	5220000230	HOLDER	S-N5054	T
F3	5210000040	FUSE	FGB 2A (FGB0 125V)	T
EP1	0910057434	PCB	B 5969D	
EP50	6910012350	S.BEAD	MMZ1608Y 102BT	B
EP51	6910012350	S.BEAD	MMZ1608Y 102BT	B
EP52	6910012350	S.BEAD	MMZ1608Y 102BT	B
EP403	6910012350	S.BEAD	MMZ1608Y 102BT	T
EP404	6910012350	S.BEAD	MMZ1608Y 102BT	T
EP408	6910012350	S.BEAD	MMZ1608Y 102BT	T
EP409	6910012350	S.BEAD	MMZ1608Y 102BT	T
EP414	6910012350	S.BEAD	MMZ1608Y 102BT	T
EP415	6910012350	S.BEAD	MMZ1608Y 102BT	B
EP416	6910012350	S.BEAD	MMZ1608Y 102BT	B
EP417	6910012350	S.BEAD	MMZ1608Y 102BT	T
EP420	6910012350	S.BEAD	MMZ1608Y 102BT	B
EP421	6910012350	S.BEAD	MMZ1608Y 102BT	T
EP430	6910012350	S.BEAD	MMZ1608Y 102BT	B
EP431	6910012350	S.BEAD	MMZ1608Y 102BT	B
EP432	6910012350	S.BEAD	MMZ1608Y 102BT	B
EP905	6910012350	S.BEAD	MMZ1608Y 102BT	B
EP907	6910012350	S.BEAD	MMZ1608Y 102BT	B

[DSP-A BOARD]

REF NO.	ORDER NO.	DESCRIPTION		M.
IC1	1140011160	S.IC	TMS320C6713GDP225	T
IC151	1130008360	S.IC	TC7SHU04FU (TE85L)	B
IC171	1130008040	S.IC	TC7SH04FU	T
IC181	1130011150	S.IC	SN74AHC2G08HDCTR	T
IC191	1130011150	S.IC	SN74AHC2G08HDCTR	T
IC201	1130012190	S.IC	AT29LV040A-20TC (SX-2590E)	B
IC301	1110006100	S.IC	NJM5534MD-TE1	T
IC331	1130009980	S.IC	TC7W53FK (TE85L)	T
IC341	1110006100	S.IC	NJM5534MD-TE1	T
IC371	1110006100	S.IC	NJM5534MD-TE1	T
IC401	1110006110	S.IC	AK5394A-VS	T
IC451	1130006890	S.IC	TC7S04FU (TE85R)	T
IC452	1130012160	S.IC	SN74LVC1GU04DCKR	T
IC501	1110001900	S.IC	μPC4570G2-T1	T
IC551	1130011460	S.IC	AK4394-VF	T
IC601	1110006100	S.IC	NJM5534MD-TE1	T
IC651	1110006100	S.IC	NJM5534MD-TE1	T
IC701	1110006100	S.IC	NJM5534MD-TE1	T
IC771	1110004770	S.IC	BU9480F-E2	T
Q1	1590000680	S.TRANSISTOR	DTC114EUA T106	T
D501	1730002320	S.ZENER	MA8051-M (TX)	B
FI101	2040000790	S.LC	EXCCE103U	T
X151	6050011660	S.XTAL	CR-754 (30.000 MHz)	B
L1	6200003950	S.COIL	HF50ACC 322513-T	B
L2	6180003500	S.COIL	SLF6028T-100M1R3	B
L3	6200003640	S.COIL	MLF1608E 100K-T	B
L401	6200003950	S.COIL	HF50ACC 322513-T	T
L921	6200003950	S.COIL	HF50ACC 322513-T	T
L922	6200003950	S.COIL	HF50ACC 322513-T	T
L924	6200003950	S.COIL	HF50ACC 322513-T	T
L925	6200003950	S.COIL	HF50ACC 322513-T	T
L961	6200003950	S.COIL	HF50ACC 322513-T	B
L962	6200003950	S.COIL	HF50ACC 322513-T	B
R1	7030003560	S.RESISTOR	ERJ3GEYJ 103 V (10 kΩ)	B

S.=Surface mount

[DSP-A BOARD]

[DSP-A BOARD]

REF NO.	ORDER NO.	DESCRIPTION	M.
R2	7030003560	S.RESISTOR ERJ3GEYJ 103 V (10 kΩ)	B
R3	7030003560	S.RESISTOR ERJ3GEYJ 103 V (10 kΩ)	B
R4	7030003560	S.RESISTOR ERJ3GEYJ 103 V (10 kΩ)	B
R5	7030003440	S.RESISTOR ERJ3GEYJ 102 V (1 kΩ)	B
R6	7030003440	S.RESISTOR ERJ3GEYJ 102 V (1 kΩ)	B
R7	7030003640	S.RESISTOR ERJ3GEYJ 473 V (47 kΩ)	B
R8	7030003410	S.RESISTOR ERJ3GEYJ 102 V (1 kΩ)	B
R9	7030003640	S.RESISTOR ERJ3GEYJ 473 V (47 kΩ)	B
R10	7030003640	S.RESISTOR ERJ3GEYJ 473 V (47 kΩ)	T
R11	7030003460	S.RESISTOR ERJ3GEYJ 152 V (1.5 kΩ)	B
R151	7030003320	S.RESISTOR ERJ3GEYJ 101 V (100 Ω)	T
R152	7030003800	S.RESISTOR ERJ3GEYJ 105 V (1 MΩ)	B
R171	7030003320	S.RESISTOR ERJ3GEYJ 101 V (100 Ω)	T
R181	7030003560	S.RESISTOR ERJ3GEYJ 103 V (10 kΩ)	T
R182	7030003560	S.RESISTOR ERJ3GEYJ 103 V (10 kΩ)	T
R183	7030003560	S.RESISTOR ERJ3GEYJ 103 V (10 kΩ)	T
R184	7030003560	S.RESISTOR ERJ3GEYJ 103 V (10 kΩ)	T
R301	7030003860	S.RESISTOR ERJ3GE JPW V	T
R302	7030009591	S.RESISTOR ERA3YED 472V	T
R303	7030009591	S.RESISTOR ERA3YED 472V	T
R304	7030003320	S.RESISTOR ERJ3GEYJ 101 V (100 Ω)	T
R305	7030003860	S.RESISTOR ERJ3GE JPW V	T
R306	7030003320	S.RESISTOR ERJ3GEYJ 101 V (100 Ω)	T
R331	7030003500	S.RESISTOR ERJ3GEYJ 332 V (3.3 kΩ)	T
R332	7030003480	S.RESISTOR ERJ3GEYJ 222 V (2.2 kΩ)	T
R333	7030003640	S.RESISTOR ERJ3GEYJ 473 V (47 kΩ)	T
R341	7030003320	S.RESISTOR ERJ3GEYJ 101 V (100 Ω)	T
R342	7030003320	S.RESISTOR ERJ3GEYJ 101 V (100 Ω)	T
R343	7030006601	S.RESISTOR ERA3YED 272V	T
R344	7030010390	S.RESISTOR ERA3YED 821V	T
R345	7030009691	S.RESISTOR ERA3YED 101V (100 Ω)	T
R371	7030003320	S.RESISTOR ERJ3GEYJ 101 V (100 Ω)	T
R372	7030003320	S.RESISTOR ERJ3GEYJ 101 V (100 Ω)	T
R373	7030006601	S.RESISTOR ERA3YED 272V	T
R374	7030010390	S.RESISTOR ERA3YED 821V	T
R375	7030009691	S.RESISTOR ERA3YED 101V (100 Ω)	T
R401	7030009591	S.RESISTOR ERA3YED 472V	T
R402	7030009591	S.RESISTOR ERA3YED 472V	T
R403	7030003640	S.RESISTOR ERJ3GEYJ 473 V (47 kΩ)	T
R404	7030003200	S.RESISTOR ERJ3GEYJ 100 V (10 Ω)	T
R405	7030003320	S.RESISTOR ERJ3GEYJ 101 V (100 Ω)	T
R406	7030003640	S.RESISTOR ERJ3GEYJ 473 V (47 kΩ)	T
R407	7030003460	S.RESISTOR ERJ3GEYJ 152 V (1.5 kΩ)	B
R409	7030003640	S.RESISTOR ERJ3GEYJ 473 V (47 kΩ)	T
R410	7030003640	S.RESISTOR ERJ3GEYJ 473 V (47 kΩ)	T
R411	7030003640	S.RESISTOR ERJ3GEYJ 473 V (47 kΩ)	T
R412	7030003520	S.RESISTOR ERJ3GEYJ 472 V (4.7 kΩ)	T
R413	7030003520	S.RESISTOR ERJ3GEYJ 472 V (4.7 kΩ)	T
R451	7030003800	S.RESISTOR ERJ3GEYJ 105 V (1 MΩ)	T
R501	7030006521	S.RESISTOR ERA3YED 561V	T
R502	7030003360	S.RESISTOR ERJ3GEYJ 221 V (220 Ω)	T
R503	7030003380	S.RESISTOR ERJ3GEYJ 331 V (330 Ω)	T
R504	7030003680	S.RESISTOR ERJ3GEYJ 104 V (100 kΩ)	T
R551	7030003320	S.RESISTOR ERJ3GEYJ 101 V (100 Ω)	T
R559	7030003640	S.RESISTOR ERJ3GEYJ 473 V (47 kΩ)	T
R601	7030006521	S.RESISTOR ERA3YED 561V	T
R602	7030007661	S.RESISTOR ERA3YED 331V	T
R603	7030007661	S.RESISTOR ERA3YED 331V	T
R604	7030009961	S.RESISTOR ERA3YED 221V (220 Ω)	T
R605	7030007661	S.RESISTOR ERA3YED 331V	T
R606	7030003320	S.RESISTOR ERJ3GEYJ 101 V (100 Ω)	T
R607	7030003320	S.RESISTOR ERJ3GEYJ 101 V (100 Ω)	T
R651	7030006521	S.RESISTOR ERA3YED 561V	T
R652	7030007661	S.RESISTOR ERA3YED 331V	T
R653	7030007661	S.RESISTOR ERA3YED 331V	T
R654	7030009961	S.RESISTOR ERA3YED 221V (220 Ω)	T
R655	7030007661	S.RESISTOR ERA3YED 331V	T
R658	7030003320	S.RESISTOR ERJ3GEYJ 101 V (100 Ω)	T
R659	7030003320	S.RESISTOR ERJ3GEYJ 101 V (100 Ω)	T
R701	7030010770	S.RESISTOR ERA3YED 681V (680 Ω)	T
R702	7030009861	S.RESISTOR ERA3YED 471V	T
R703	7030010770	S.RESISTOR ERA3YED 681V (680 Ω)	T
R704	7030009861	S.RESISTOR ERA3YED 471V	T
R705	7030009691	S.RESISTOR ERA3YED 101V (100 Ω)	T
R706	7030003320	S.RESISTOR ERJ3GEYJ 101 V (100 Ω)	T
R707	7030003320	S.RESISTOR ERJ3GEYJ 101 V (100 Ω)	T
R801	7030003650	S.RESISTOR ERJ3GEYJ 563 V (56 kΩ)	T
R802	7030003680	S.RESISTOR ERJ3GEYJ 104 V (100 kΩ)	T
R803	7030003480	S.RESISTOR ERJ3GEYJ 222 V (2.2 kΩ)	T
R804	7030003490	S.RESISTOR ERJ3GEYJ 272 V (2.7 kΩ)	T
R805	7030003340	S.RESISTOR ERJ3GEYJ 151 V (150 Ω)	T
R901	7030003860	S.RESISTOR ERJ3GE JPW V	T
R962	7030003320	S.RESISTOR ERJ3GEYJ 101 V (100 Ω)	T
R963	7030003320	S.RESISTOR ERJ3GEYJ 101 V (100 Ω)	T
R964	7030003320	S.RESISTOR ERJ3GEYJ 101 V (100 Ω)	T
R965	7030003320	S.RESISTOR ERJ3GEYJ 101 V (100 Ω)	T
R967	7030003320	S.RESISTOR ERJ3GEYJ 101 V (100 Ω)	T
R968	7030003320	S.RESISTOR ERJ3GEYJ 101 V (100 Ω)	T

REF NO.	ORDER NO.	DESCRIPTION	M.
R969	7030003320	S.RESISTOR ERJ3GEYJ 101 V (100 Ω)	T
R970	7030003320	S.RESISTOR ERJ3GEYJ 101 V (100 Ω)	T
R971	7030003320	S.RESISTOR ERJ3GEYJ 101 V (100 Ω)	T
R972	7030003320	S.RESISTOR ERJ3GEYJ 101 V (100 Ω)	T
R973	7030003320	S.RESISTOR ERJ3GEYJ 101 V (100 Ω)	T
R974	7030003320	S.RESISTOR ERJ3GEYJ 101 V (100 Ω)	T
R975	7030003320	S.RESISTOR ERJ3GEYJ 101 V (100 Ω)	T
R976	7030003320	S.RESISTOR ERJ3GEYJ 101 V (100 Ω)	T
C1	4030011600	S.CERAMIC C1608 JB 1E 104K-T	B
C2	4030011600	S.CERAMIC C1608 JB 1E 104K-T	B
C3	4030011600	S.CERAMIC C1608 JB 1E 104K-T	B
C4	4030011600	S.CERAMIC C1608 JB 1E 104K-T	B
C5	4030011600	S.CERAMIC C1608 JB 1E 104K-T	B
C6	4030011600	S.CERAMIC C1608 JB 1E 104K-T	B
C7	4030011600	S.CERAMIC C1608 JB 1E 104K-T	B
C8	4030011600	S.CERAMIC C1608 JB 1E 104K-T	B
C9	4030011600	S.CERAMIC C1608 JB 1E 104K-T	B
C10	4030011600	S.CERAMIC C1608 JB 1E 104K-T	B
C11	4030011600	S.CERAMIC C1608 JB 1E 104K-T	B
C12	4030011600	S.CERAMIC C1608 JB 1E 104K-T	T
C13	4030011600	S.CERAMIC C1608 JB 1E 104K-T	B
C14	4030011600	S.CERAMIC C1608 JB 1E 104K-T	B
C15	4030011600	S.CERAMIC C1608 JB 1E 104K-T	B
C16	4030011600	S.CERAMIC C1608 JB 1E 104K-T	B
C17	4030011600	S.CERAMIC C1608 JB 1E 104K-T	T
C18	4030011600	S.CERAMIC C1608 JB 1E 104K-T	B
C19	4030011600	S.CERAMIC C1608 JB 1E 104K-T	B
C20	4030011600	S.CERAMIC C1608 JB 1E 104K-T	B
C21	4030011600	S.CERAMIC C1608 JB 1E 104K-T	B
C22	4030011600	S.CERAMIC C1608 JB 1E 104K-T	B
C23	4030011600	S.CERAMIC C1608 JB 1E 104K-T	B
C24	4030011600	S.CERAMIC C1608 JB 1E 104K-T	B
C25	4030011600	S.CERAMIC C1608 JB 1E 104K-T	B
C26	4030011600	S.CERAMIC C1608 JB 1E 104K-T	B
C27	4030011600	S.CERAMIC C1608 JB 1E 104K-T	B
C28	4030011600	S.CERAMIC C1608 JB 1E 104K-T	B
C29	4030011600	S.CERAMIC C1608 JB 1E 104K-T	B
C30	4030011600	S.CERAMIC C1608 JB 1E 104K-T	T
C31	4030011600	S.CERAMIC C1608 JB 1E 104K-T	T
C32	4030011600	S.CERAMIC C1608 JB 1E 104K-T	T
C33	4030011600	S.CERAMIC C1608 JB 1E 104K-T	T
C34	4030011600	S.CERAMIC C1608 JB 1E 104K-T	T
C35	4030011600	S.CERAMIC C1608 JB 1E 104K-T	B
C36	4030011600	S.CERAMIC C1608 JB 1E 104K-T	B
C37	4030011600	S.CERAMIC C1608 JB 1E 104K-T	B
C38	4030011600	S.CERAMIC C1608 JB 1E 104K-T	B
C39	4030011600	S.CERAMIC C1608 JB 1E 104K-T	B
C40	4030011600	S.CERAMIC C1608 JB 1E 104K-T	B
C41	4030011600	S.CERAMIC C1608 JB 1E 104K-T	B
C42	4030011600	S.CERAMIC C1608 JB 1E 104K-T	B
C43	4030011600	S.CERAMIC C1608 JB 1E 104K-T	B
C44	4030011600	S.CERAMIC C1608 JB 1E 104K-T	B
C45	4030011600	S.CERAMIC C1608 JB 1E 104K-T	B
C46	4030011600	S.CERAMIC C1608 JB 1E 104K-T	B
C47	4030011600	S.CERAMIC C1608 JB 1E 104K-T	T
C48	4030011600	S.CERAMIC C1608 JB 1E 104K-T	B
C49	4030011600	S.CERAMIC C1608 JB 1E 104K-T	B
C50	4030011600	S.CERAMIC C1608 JB 1E 104K-T	B
C51	4030011600	S.CERAMIC C1608 JB 1E 104K-T	B
C52	4030011600	S.CERAMIC C1608 JB 1E 104K-T	B
C53	4030011600	S.CERAMIC C1608 JB 1E 104K-T	B
C54	4030011600	S.CERAMIC C1608 JB 1E 104K-T	T
C55	4030011600	S.CERAMIC C1608 JB 1E 104K-T	B
C56	4030011600	S.CERAMIC C1608 JB 1E 104K-T	B
C57	4030011600	S.CERAMIC C1608 JB 1E 104K-T	B
C58	4030011600	S.CERAMIC C1608 JB 1E 104K-T	B
C59	4030011600	S.CERAMIC C1608 JB 1E 104K-T	T
C60	4510007130	S.ELECTROLYTIC EEFCD 0J 470R	T
C61	4550006200	S.TANTALUM ECST0JY106R	B
C62	4510007130	S.ELECTROLYTIC EEFCD 0J 470R	T
C101	4030011600	S.CERAMIC C1608 JB 1E 104K-T	T
C102	4550006200	S.TANTALUM ECST0JY106R	B
C151	4030011600	S.CERAMIC C1608 JB 1E 104K-T	B
C152	4030007030	S.CERAMIC C1608 CH 1H 150J-T	B
C153	4030007030	S.CERAMIC C1608 CH 1H 150J-T	B
C171	4030011600	S.CERAMIC C1608 JB 1E 104K-T	T
C181	4030011600	S.CERAMIC C1608 JB 1E 104K-T	T
C191	4030011600	S.CERAMIC C1608 JB 1E 104K-T	T
C201	4030011600	S.CERAMIC C1608 JB 1E 104K-T	B
C301	4340000250	S.MYLAR ECHU 1C 104JX5	T
C302	4550006820	S.TANTALUM ECST1DX106R	B
C303	4030011600	S.CERAMIC C1608 JB 1E 104K-T	T
C304	4550006820	S.TANTALUM ECST1DX106R	B
C305	4030011600	S.CERAMIC C1608 JB 1E 104K-T	T
C306	4030007050	S.CERAMIC C1608 CH 1H 220J-T	T
C331	4030011600	S.CERAMIC C1608 JB 1E 104K-T	T

M.=Mounted side (T: Mounted on the Top side, B: Mounted on the Bottom side)

S.=Surface mount

[DSP-A BOARD]

REF NO.	ORDER NO.	DESCRIPTION	M.
C332	4550006700	S.TANTALUM ECST1AY106R	B
C333	4030011600	S.CERAMIC C1608 JB 1E 104K-T	T
C341	4550006820	S.TANTALUM ECST1DX106R	B
C342	4030011600	S.CERAMIC C1608 JB 1E 104K-T	T
C343	4550006820	S.TANTALUM ECST1DX106R	B
C344	4030011600	S.CERAMIC C1608 JB 1E 104K-T	T
C345	4340000250	S.MYLAR ECHU 1C 104JX5	T
C346	4030018580	S.CERAMIC C1608 CH 1H 821J-T	T
C347	4030011600	S.CERAMIC C1608 JB 1E 104K-T	T
C348	4030007050	S.CERAMIC C1608 CH 1H 220J-T	T
C371	4550006820	S.TANTALUM ECST1DX106R	B
C372	4030011600	S.CERAMIC C1608 JB 1E 104K-T	T
C373	4550006820	S.TANTALUM ECST1DX106R	B
C374	4030011600	S.CERAMIC C1608 JB 1E 104K-T	T
C375	4340000250	S.MYLAR ECHU 1C 104JX5	T
C376	4030018580	S.CERAMIC C1608 CH 1H 821J-T	T
C377	4030011600	S.CERAMIC C1608 JB 1E 104K-T	T
C378	4030007050	S.CERAMIC C1608 CH 1H 220J-T	T
C401	4550006700	S.TANTALUM ECST1AY106R	B
C402	4030017840	S.CERAMIC C2012 CH 1H 222J-T	T
C403	4550006200	S.TANTALUM ECST0JY106R	B
C404	4030011810	S.CERAMIC C1608 JB 1A 224K-T	T
C405	4550006200	S.TANTALUM ECST0JY106R	B
C406	4030011810	S.CERAMIC C1608 JB 1A 224K-T	T
C407	4550006200	S.TANTALUM ECST0JY106R	B
C408	4030011600	S.CERAMIC C1608 JB 1E 104K-T	T
C409	4030011600	S.CERAMIC C1608 JB 1E 104K-T	T
C410	4030009000	S.CERAMIC C2012 JB 1C 224K-T	T
C411	4550006200	S.TANTALUM ECST0JY106R	B
C412	4550006200	S.TANTALUM ECST0JY106R	B
C413	4030009000	S.CERAMIC C2012 JB 1C 224K-T	T
C414	4030011600	S.CERAMIC C1608 JB 1E 104K-T	T
C415	4550006700	S.TANTALUM ECST1AY106R	B
C416	4550006700	S.TANTALUM ECST1AY106R	B
C417	4030017840	S.CERAMIC C2012 CH 1H 222J-T	T
C450	4030011600	S.CERAMIC C1608 JB 1E 104K-T	T
C451	4030011600	S.CERAMIC C1608 JB 1E 104K-T	T
C452	4030006860	S.CERAMIC C1608 JB 1H 102K-T	T
C501	4030011600	S.CERAMIC C1608 JB 1E 104K-T	T
C502	4550006820	S.TANTALUM ECST1DX106R	B
C503	4030011600	S.CERAMIC C1608 JB 1E 104K-T	T
C504	4550006820	S.TANTALUM ECST1DX106R	B
C506	4030007090	S.CERAMIC C1608 CH 1H 470J-T	T
C507	4030007090	S.CERAMIC C1608 CH 1H 470J-T	T
C551	4550006700	S.TANTALUM ECST1AY106R	B
C552	4030011600	S.CERAMIC C1608 JB 1E 104K-T	T
C553	4550006700	S.TANTALUM ECST1AY106R	B
C554	4030011600	S.CERAMIC C1608 JB 1E 104K-T	T
C555	4030011600	S.CERAMIC C1608 JB 1E 104K-T	T
C556	4550006200	S.TANTALUM ECST0JY106R	B
C557	4030011600	S.CERAMIC C1608 JB 1E 104K-T	T
C558	4550006700	S.TANTALUM ECST1AY106R	B
C601	4550006200	S.TANTALUM ECST0JY106R	B
C602	4030018510	S.CERAMIC C2012 CH 1H 682J-T	T
C603	4550006820	S.TANTALUM ECST1DX106R	B
C604	4030011600	S.CERAMIC C1608 JB 1E 104K-T	T
C605	4030011600	S.CERAMIC C1608 JB 1E 104K-T	T
C606	4550006820	S.TANTALUM ECST1DX106R	B
C607	4030018510	S.CERAMIC C2012 CH 1H 682J-T	T
C608	4030007050	S.CERAMIC C1608 CH 1H 220J-T	T
C651	4550006200	S.TANTALUM ECST0JY106R	B
C652	4030018510	S.CERAMIC C2012 CH 1H 682J-T	T
C653	4550006820	S.TANTALUM ECST1DX106R	B
C654	4030011600	S.CERAMIC C1608 JB 1E 104K-T	T
C655	4030011600	S.CERAMIC C1608 JB 1E 104K-T	T
C656	4550006820	S.TANTALUM ECST1DX106R	B
C657	4030018510	S.CERAMIC C2012 CH 1H 682J-T	T
C658	4030007050	S.CERAMIC C1608 CH 1H 220J-T	T
C701	4030017840	S.CERAMIC C2012 CH 1H 222J-T	T
C702	4030017840	S.CERAMIC C2012 CH 1H 222J-T	T
C703	4550006820	S.TANTALUM ECST1DX106R	B
C704	4030011600	S.CERAMIC C1608 JB 1E 104K-T	T
C705	4030011600	S.CERAMIC C1608 JB 1E 104K-T	T
C706	4550006820	S.TANTALUM ECST1DX106R	B
C707	4030007050	S.CERAMIC C1608 CH 1H 220J-T	T
C771	4550006200	S.TANTALUM ECST0JY106R	B
C772	4030011600	S.CERAMIC C1608 JB 1E 104K-T	T
C773	4550006200	S.TANTALUM ECST0JY106R	B
C801	4030011600	S.CERAMIC C1608 JB 1E 104K-T	T
C921	4550006210	S.TANTALUM ECST1CX106R	B
C922	4030011600	S.CERAMIC C1608 JB 1E 104K-T	T
C923	4550002830	S.TANTALUM TEESVD2 1V 685M12R	B
C924	4030011600	S.CERAMIC C1608 JB 1E 104K-T	T
C925	4550006210	S.TANTALUM ECST1CX106R	B
C926	4030011600	S.CERAMIC C1608 JB 1E 104K-T	T
C927	4550002830	S.TANTALUM TEESVD2 1V 685M12R	B
C928	4030011600	S.CERAMIC C1608 JB 1E 104K-T	T
C961	4030011600	S.CERAMIC C1608 JB 1E 104K-T	B

M.-Mounted side (T: Mounted on the Top side, B: Mounted on the Bottom side)

[DSP-A BOARD]

REF NO.	ORDER NO.	DESCRIPTION	M.
C962	4550006700	S.TANTALUM ECST1AY106R	B
C963	4030011600	S.CERAMIC C1608 JB 1E 104K-T	B
C964	4550006700	S.TANTALUM ECST1AY106R	B
J201	6510024450	S.CONNECTOR IC197-3202-2000	B
J921	6910013900	CONNECTOR IMSA-9180S-22A	B
J961	6910012460	CONNECTOR IMSA-9180S-30A	B
EP1	0910057622	PCB B 5970B	

[DSP-B BOARD]

REF NO.	ORDER NO.	DESCRIPTION	M.
IC1	1140011160	S.IC TMS320C6713GDP225	T
IC151	1130008360	S.IC TC7SHU04FU (TE85L)	B
IC171	1130008040	S.IC TC7SH04FU	T
IC181	1130011150	S.IC SN74AHC2G08HDCTR	T
IC191	1130011150	S.IC SN74AHC2G08HDCTR	T
IC201	1130012190	S.IC AT29LV040A-20TC (SX-2590E)	B
IC301	1110006100	S.IC NJM5534MD-TE1	T
IC331	1130009980	S.IC TC7W53FK (TE85L)	T
IC341	1110006100	S.IC NJM5534MD-TE1	T
IC371	1110006100	S.IC NJM5534MD-TE1	T
IC401	1110006110	S.IC AK5394A-VS	T
IC451	1130006890	S.IC TC7S04FU (TE85R)	T
IC452	1130012160	S.IC SN74LVC1GU04DCKR	T
IC501	1110001900	S.IC µPC4570G2-T1	T
IC551	1130011460	S.IC AK4394-VF	T
IC601	1110006100	S.IC NJM5534MD-TE1	T
IC651	1110006100	S.IC NJM5534MD-TE1	T
IC701	1110006100	S.IC NJM5534MD-TE1	T
IC771	1110004770	S.IC BU9480F-E2	T
Q1	1590000680	S.TRANSISTOR DTC114EUA T106	T
D501	1730002320	S.ZENER MA8051-M (TX)	B
FI101	2040000790	S.LC EXOCET103UJ	T
X151	6050011660	S.XTAL CR-754 (30.000 MHz)	B
L1	6200003950	S.COIL HF50ACC 322513-T	B
L2	6180003500	S.COIL SLF6028T-100M1R3	B
L3	6200003640	S.COIL MLF1608E 100K-T	B
L401	6200003950	S.COIL HF50ACC 322513-T	T
L921	6200003950	S.COIL HF50ACC 322513-T	T
L922	6200003950	S.COIL HF50ACC 322513-T	T
L924	6200003950	S.COIL HF50ACC 322513-T	T
L925	6200003950	S.COIL HF50ACC 322513-T	T
L961	6200003950	S.COIL HF50ACC 322513-T	B
L962	6200003950	S.COIL HF50ACC 322513-T	B
R1	7030003560	S.RESISTOR ERJ3GEYJ 103 V (10 kΩ)	B
R2	7030003560	S.RESISTOR ERJ3GEYJ 103 V (10 kΩ)	B
R3	7030003560	S.RESISTOR ERJ3GEYJ 103 V (10 kΩ)	B
R4	7030003560	S.RESISTOR ERJ3GEYJ 103 V (10 kΩ)	B
R5	7030003440	S.RESISTOR ERJ3GEYJ 102 V (1 kΩ)	B
R6	7030003440	S.RESISTOR ERJ3GEYJ 102 V (1 kΩ)	B
R7	7030003640	S.RESISTOR ERJ3GEYJ 473 V (47 kΩ)	B
R8	7030003440	S.RESISTOR ERJ3GEYJ 102 V (1 kΩ)	B
R9	7030003640	S.RESISTOR ERJ3GEYJ 473 V (47 kΩ)	B
R10	7030003640	S.RESISTOR ERJ3GEYJ 473 V (47 kΩ)	T
R11	7030003460	S.RESISTOR ERJ3GEYJ 152 V (1.5 kΩ)	B
R151	7030003320	S.RESISTOR ERJ3GEYJ 101 V (100 Ω)	T
R152	7030003800	S.RESISTOR ERJ3GEYJ 105 V (1 MΩ)	B
R171	7030003320	S.RESISTOR ERJ3GEYJ 101 V (100 Ω)	T
R181	7030003560	S.RESISTOR ERJ3GEYJ 103 V (10 kΩ)	T
R182	7030003560	S.RESISTOR ERJ3GEYJ 103 V (10 kΩ)	T
R183	7030003560	S.RESISTOR ERJ3GEYJ 103 V (10 kΩ)	T
R184	7030003560	S.RESISTOR ERJ3GEYJ 103 V (10 kΩ)	T
R301	7030003860	S.RESISTOR ERJ3GE JPW V	T
R302	70300009591	S.RESISTOR ERA3YED 472V	T
R303	70300009591	S.RESISTOR ERA3YED 472V	T

S.-Surface mount

[DSP-B BOARD]

REF NO.	ORDER NO.	DESCRIPTION	M.
R304	7030003320	S.RESISTOR ERJ3GEYJ 101 V (100 Ω)	T
R305	7030003860	S.RESISTOR ERJ3GE JPW V	T
R306	7030003320	S.RESISTOR ERJ3GEYJ 101 V (100 Ω)	T
R331	7030003500	S.RESISTOR ERJ3GEYJ 332 V (3.3 kΩ)	T
R332	7030003480	S.RESISTOR ERJ3GEYJ 222 V (2.2 kΩ)	T
R333	7030003640	S.RESISTOR ERJ3GEYJ 473 V (47 kΩ)	T
R341	7030003320	S.RESISTOR ERJ3GEYJ 101 V (100 Ω)	T
R342	7030003320	S.RESISTOR ERJ3GEYJ 101 V (100 Ω)	T
R343	7030006601	S.RESISTOR ERA3YED 272V	T
R344	7030010390	S.RESISTOR ERA3YED 821V	T
R345	7030009691	S.RESISTOR ERA3YED 101V (100 Ω)	T
R371	7030003320	S.RESISTOR ERJ3GEYJ 101 V (100 Ω)	T
R372	7030003320	S.RESISTOR ERJ3GEYJ 101 V (100 Ω)	T
R373	7030006601	S.RESISTOR ERA3YED 272V	T
R374	7030010390	S.RESISTOR ERA3YED 821V	T
R375	7030009691	S.RESISTOR ERA3YED 101V (100 Ω)	T
R401	7030009591	S.RESISTOR ERA3YED 472V	T
R402	7030009591	S.RESISTOR ERA3YED 472V	T
R403	7030003640	S.RESISTOR ERJ3GEYJ 473 V (47 kΩ)	T
R404	7030003200	S.RESISTOR ERJ3GEYJ 100 V (10 Ω)	T
R405	7030003320	S.RESISTOR ERJ3GEYJ 101 V (100 Ω)	T
R406	7030003640	S.RESISTOR ERJ3GEYJ 473 V (47 kΩ)	T
R407	7030003460	S.RESISTOR ERJ3GEYJ 152 V (1.5 kΩ)	B
R409	7030003640	S.RESISTOR ERJ3GEYJ 473 V (47 kΩ)	T
R410	7030003640	S.RESISTOR ERJ3GEYJ 473 V (47 kΩ)	T
R411	7030003640	S.RESISTOR ERJ3GEYJ 473 V (47 kΩ)	T
R412	7030003520	S.RESISTOR ERJ3GEYJ 472 V (4.7 kΩ)	T
R413	7030003520	S.RESISTOR ERJ3GEYJ 472 V (4.7 kΩ)	T
R451	7030003800	S.RESISTOR ERJ3GEYJ 105 V (1 MΩ)	T
R501	7030006521	S.RESISTOR ERA3YED 561V	T
R502	7030003360	S.RESISTOR ERJ3GEYJ 221 V (220 Ω)	T
R503	7030003380	S.RESISTOR ERJ3GEYJ 331 V (330 Ω)	T
R504	7030003680	S.RESISTOR ERJ3GEYJ 104 V (100 kΩ)	T
R551	7030003320	S.RESISTOR ERJ3GEYJ 101 V (100 Ω)	T
R559	7030003640	S.RESISTOR ERJ3GEYJ 473 V (47 kΩ)	T
R601	7030006521	S.RESISTOR ERA3YED 561V	T
R602	7030007661	S.RESISTOR ERA3YED 331V	T
R603	7030007661	S.RESISTOR ERA3YED 331V	T
R604	7030009961	S.RESISTOR ERA3YED 221V (220 Ω)	T
R605	7030007661	S.RESISTOR ERA3YED 331V	T
R606	7030003320	S.RESISTOR ERJ3GEYJ 101 V (100 Ω)	T
R607	7030003320	S.RESISTOR ERJ3GEYJ 101 V (100 Ω)	T
R651	7030006521	S.RESISTOR ERA3YED 561V	T
R652	7030007661	S.RESISTOR ERA3YED 331V	T
R653	7030007661	S.RESISTOR ERA3YED 331V	T
R654	7030009961	S.RESISTOR ERA3YED 221V (220 Ω)	T
R655	7030007661	S.RESISTOR ERA3YED 331V	T
R658	7030003320	S.RESISTOR ERJ3GEYJ 101 V (100 Ω)	T
R659	7030003320	S.RESISTOR ERJ3GEYJ 101 V (100 Ω)	T
R701	7030010770	S.RESISTOR ERA3YED 681V (680 Ω)	T
R702	7030009861	S.RESISTOR ERA3YED 471V	T
R703	7030010770	S.RESISTOR ERA3YED 681V (680 Ω)	T
R704	7030009861	S.RESISTOR ERA3YED 471V	T
R705	7030009691	S.RESISTOR ERA3YED 101V (100 Ω)	T
R706	7030003320	S.RESISTOR ERJ3GEYJ 101 V (100 Ω)	T
R707	7030003320	S.RESISTOR ERJ3GEYJ 101 V (100 Ω)	T
R801	7030003650	S.RESISTOR ERJ3GEYJ 563 V (56 kΩ)	T
R802	7030003680	S.RESISTOR ERJ3GEYJ 104 V (100 kΩ)	T
R803	7030003480	S.RESISTOR ERJ3GEYJ 222 V (2.2 kΩ)	T
R804	7030003490	S.RESISTOR ERJ3GEYJ 272 V (2.7 kΩ)	T
R805	7030003340	S.RESISTOR ERJ3GEYJ 151 V (150 Ω)	T
R901	7030003860	S.RESISTOR ERJ3GE JPW V	T
R962	7030003320	S.RESISTOR ERJ3GEYJ 101 V (100 Ω)	T
R963	7030003320	S.RESISTOR ERJ3GEYJ 101 V (100 Ω)	T
R964	7030003320	S.RESISTOR ERJ3GEYJ 101 V (100 Ω)	T
R965	7030003320	S.RESISTOR ERJ3GEYJ 101 V (100 Ω)	T
R967	7030003320	S.RESISTOR ERJ3GEYJ 101 V (100 Ω)	T
R968	7030003320	S.RESISTOR ERJ3GEYJ 101 V (100 Ω)	T
R969	7030003320	S.RESISTOR ERJ3GEYJ 101 V (100 Ω)	T
R970	7030003320	S.RESISTOR ERJ3GEYJ 101 V (100 Ω)	T
R971	7030003320	S.RESISTOR ERJ3GEYJ 101 V (100 Ω)	T
R972	7030003320	S.RESISTOR ERJ3GEYJ 101 V (100 Ω)	T
R973	7030003320	S.RESISTOR ERJ3GEYJ 101 V (100 Ω)	T
R974	7030003320	S.RESISTOR ERJ3GEYJ 101 V (100 Ω)	T
R975	7030003320	S.RESISTOR ERJ3GEYJ 101 V (100 Ω)	T
R976	7030003320	S.RESISTOR ERJ3GEYJ 101 V (100 Ω)	T
C1	4030011600	S.CERAMIC C1608 JB 1E 104K-T	B
C2	4030011600	S.CERAMIC C1608 JB 1E 104K-T	B
C3	4030011600	S.CERAMIC C1608 JB 1E 104K-T	B
C4	4030011600	S.CERAMIC C1608 JB 1E 104K-T	B
C5	4030011600	S.CERAMIC C1608 JB 1E 104K-T	B
C6	4030011600	S.CERAMIC C1608 JB 1E 104K-T	B
C7	4030011600	S.CERAMIC C1608 JB 1E 104K-T	B
C8	4030011600	S.CERAMIC C1608 JB 1E 104K-T	B
C9	4030011600	S.CERAMIC C1608 JB 1E 104K-T	B
C10	4030011600	S.CERAMIC C1608 JB 1E 104K-T	B

[DSP-B BOARD]

REF NO.	ORDER NO.	DESCRIPTION	M.
C11	4030011600	S.CERAMIC C1608 JB 1E 104K-T	B
C12	4030011600	S.CERAMIC C1608 JB 1E 104K-T	T
C13	4030011600	S.CERAMIC C1608 JB 1E 104K-T	T
C14	4030011600	S.CERAMIC C1608 JB 1E 104K-T	B
C15	4030011600	S.CERAMIC C1608 JB 1E 104K-T	B
C16	4030011600	S.CERAMIC C1608 JB 1E 104K-T	B
C17	4030011600	S.CERAMIC C1608 JB 1E 104K-T	T
C18	4030011600	S.CERAMIC C1608 JB 1E 104K-T	B
C19	4030011600	S.CERAMIC C1608 JB 1E 104K-T	B
C20	4030011600	S.CERAMIC C1608 JB 1E 104K-T	B
C21	4030011600	S.CERAMIC C1608 JB 1E 104K-T	B
C22	4030011600	S.CERAMIC C1608 JB 1E 104K-T	B
C23	4030011600	S.CERAMIC C1608 JB 1E 104K-T	B
C24	4030011600	S.CERAMIC C1608 JB 1E 104K-T	B
C25	4030011600	S.CERAMIC C1608 JB 1E 104K-T	B
C26	4030011600	S.CERAMIC C1608 JB 1E 104K-T	B
C27	4030011600	S.CERAMIC C1608 JB 1E 104K-T	B
C28	4030011600	S.CERAMIC C1608 JB 1E 104K-T	B
C29	4030011600	S.CERAMIC C1608 JB 1E 104K-T	B
C30	4030011600	S.CERAMIC C1608 JB 1E 104K-T	T
C31	4030011600	S.CERAMIC C1608 JB 1E 104K-T	T
C32	4030011600	S.CERAMIC C1608 JB 1E 104K-T	T
C33	4030011600	S.CERAMIC C1608 JB 1E 104K-T	T
C34	4030011600	S.CERAMIC C1608 JB 1E 104K-T	T
C35	4030011600	S.CERAMIC C1608 JB 1E 104K-T	B
C36	4030011600	S.CERAMIC C1608 JB 1E 104K-T	B
C37	4030011600	S.CERAMIC C1608 JB 1E 104K-T	B
C38	4030011600	S.CERAMIC C1608 JB 1E 104K-T	B
C39	4030011600	S.CERAMIC C1608 JB 1E 104K-T	B
C40	4030011600	S.CERAMIC C1608 JB 1E 104K-T	B
C41	4030011600	S.CERAMIC C1608 JB 1E 104K-T	B
C42	4030011600	S.CERAMIC C1608 JB 1E 104K-T	B
C43	4030011600	S.CERAMIC C1608 JB 1E 104K-T	B
C44	4030011600	S.CERAMIC C1608 JB 1E 104K-T	B
C45	4030011600	S.CERAMIC C1608 JB 1E 104K-T	B
C46	4030011600	S.CERAMIC C1608 JB 1E 104K-T	B
C47	4030011600	S.CERAMIC C1608 JB 1E 104K-T	T
C48	4030011600	S.CERAMIC C1608 JB 1E 104K-T	B
C49	4030011600	S.CERAMIC C1608 JB 1E 104K-T	B
C50	4030011600	S.CERAMIC C1608 JB 1E 104K-T	B
C51	4030011600	S.CERAMIC C1608 JB 1E 104K-T	B
C52	4030011600	S.CERAMIC C1608 JB 1E 104K-T	B
C53	4030011600	S.CERAMIC C1608 JB 1E 104K-T	B
C54	4030011600	S.CERAMIC C1608 JB 1E 104K-T	T
C55	4030011600	S.CERAMIC C1608 JB 1E 104K-T	T
C56	4030011600	S.CERAMIC C1608 JB 1E 104K-T	B
C57	4030011600	S.CERAMIC C1608 JB 1E 104K-T	B
C58	4030011600	S.CERAMIC C1608 JB 1E 104K-T	B
C59	4030011600	S.CERAMIC C1608 JB 1E 104K-T	T
C60	4510007130	S.ELECTROLYTIC EEFCD 0J 470R	T
C61	4550006200	S.TANTALUM ECST0JY106R	B
C62	4510007130	S.ELECTROLYTIC EEFCD 0J 470R	T
C101	4030011600	S.CERAMIC C1608 JB 1E 104K-T	T
C102	4550006200	S.TANTALUM ECST0JY106R	B
C151	4030011600	S.CERAMIC C1608 JB 1E 104K-T	T
C152	4030007030	S.CERAMIC C1608 CH 1H 150J-T	B
C153	4030007030	S.CERAMIC C1608 CH 1H 150J-T	B
C171	4030011600	S.CERAMIC C1608 JB 1E 104K-T	T
C181	4030011600	S.CERAMIC C1608 JB 1E 104K-T	T
C191	4030011600	S.CERAMIC C1608 JB 1E 104K-T	T
C201	4030011600	S.CERAMIC C1608 JB 1E 104K-T	B
C301	4340000250	S.MYLAR ECHU 1C 104JX5	T
C302	4550006820	S.TANTALUM ECST1DX106R	B
C303	4030011600	S.CERAMIC C1608 JB 1E 104K-T	T
C304	4550006820	S.TANTALUM ECST1DX106R	B
C305	4030011600	S.CERAMIC C1608 JB 1E 104K-T	T
C306	4030007050	S.CERAMIC C1608 CH 1H 220J-T	T
C331	4030011600	S.CERAMIC C1608 JB 1E 104K-T	T
C332	4550006700	S.TANTALUM ECST1AY106R	B
C333	4030011600	S.CERAMIC C1608 JB 1E 104K-T	T
C341	4550006820	S.TANTALUM ECST1DX106R	B
C342	4030011600	S.CERAMIC C1608 JB 1E 104K-T	T
C343	4550006820	S.TANTALUM ECST1DX106R	B
C344	4030011600	S.CERAMIC C1608 JB 1E 104K-T	T
C345	4340000250	S.MYLAR ECHU 1C 104JX5	T
C346	4030018580	S.CERAMIC C1608 CH 1H 821J-T	T
C347	4030011600	S.CERAMIC C1608 JB 1E 104K-T	T
C348	4030007050	S.CERAMIC C1608 CH 1H 220J-T	T
C371	4550006820	S.TANTALUM ECST1DX106R	B
C372	4030011600	S.CERAMIC C1608 JB 1E 104K-T	T
C373	4550006820	S.TANTALUM ECST1DX106R	B
C374	4030011600	S.CERAMIC C1608 JB 1E 104K-T	T
C375	4340000250	S.MYLAR ECHU 1C 104JX5	T
C376	4030018580	S.CERAMIC C1608 CH 1H 821J-T	T
C377	4030011600	S.CERAMIC C1608 JB 1E 104K-T	T
C378	4030007050	S.CERAMIC C1608 CH 1H 220J-T	T
C401	4550006700	S.TANTALUM ECST1AY106R	B
C402	4030017840	S.CERAMIC C2012 CH 1H 222J-T	T

M.=Mounted side (T: Mounted on the Top side, B: Mounted on the Bottom side)

S.=Surface mount

[DSP-B BOARD]

REF NO.	ORDER NO.	DESCRIPTION	M.
C403	4550006200	S.TANTALUM ECST0JY106R	B
C404	4030011810	S.CERAMIC C1608 JB 1A 224K-T	T
C405	4550006200	S.TANTALUM ECST0JY106R	B
C406	4030011810	S.CERAMIC C1608 JB 1A 224K-T	T
C407	4550006200	S.TANTALUM ECST0JY106R	B
C408	4030011600	S.CERAMIC C1608 JB 1E 104K-T	T
C409	4030011600	S.CERAMIC C1608 JB 1E 104K-T	T
C410	4030009000	S.CERAMIC C2012 JB 1C 224K-T	T
C411	4550006200	S.TANTALUM ECST0JY106R	B
C412	4550006200	S.TANTALUM ECST0JY106R	B
C413	4030009000	S.CERAMIC C2012 JB 1C 224K-T	T
C414	4030011600	S.CERAMIC C1608 JB 1E 104K-T	T
C415	4550006700	S.TANTALUM ECST1AY106R	B
C416	4550006700	S.TANTALUM ECST1AY106R	B
C417	4030017840	S.CERAMIC C2012 CH 1H 222J-T	T
C450	4030011600	S.CERAMIC C1608 JB 1E 104K-T	T
C451	4030011600	S.CERAMIC C1608 JB 1E 104K-T	T
C452	4030006860	S.CERAMIC C1608 JB 1H 102K-T	T
C501	4030011600	S.CERAMIC C1608 JB 1E 104K-T	T
C502	4550006820	S.TANTALUM ECST1DX106R	B
C503	4030011600	S.CERAMIC C1608 JB 1E 104K-T	T
C504	4550006820	S.TANTALUM ECST1DX106R	B
C506	4030007090	S.CERAMIC C1608 CH 1H 470J-T	T
C507	4030007090	S.CERAMIC C1608 CH 1H 470J-T	T
C551	4550006700	S.TANTALUM ECST1AY106R	B
C552	4030011600	S.CERAMIC C1608 JB 1E 104K-T	T
C553	4550006700	S.TANTALUM ECST1AY106R	B
C554	4030011600	S.CERAMIC C1608 JB 1E 104K-T	T
C555	4030011600	S.CERAMIC C1608 JB 1E 104K-T	T
C556	4550006200	S.TANTALUM ECST0JY106R	B
C557	4030011600	S.CERAMIC C1608 JB 1E 104K-T	T
C558	4550006700	S.TANTALUM ECST1AY106R	B
C601	4550006200	S.TANTALUM ECST0JY106R	B
C602	4030018510	S.CERAMIC C2012 CH 1H 682J-T	T
C603	4550006820	S.TANTALUM ECST1DX106R	B
C604	4030011600	S.CERAMIC C1608 JB 1E 104K-T	T
C605	4030011600	S.CERAMIC C1608 JB 1E 104K-T	T
C606	4550006820	S.TANTALUM ECST1DX106R	B
C607	4030018510	S.CERAMIC C2012 CH 1H 682J-T	T
C608	4030007050	S.CERAMIC C1608 CH 1H 220J-T	T
C651	4550006200	S.TANTALUM ECST0JY106R	B
C652	4030018510	S.CERAMIC C2012 CH 1H 682J-T	T
C653	4550006820	S.TANTALUM ECST1DX106R	B
C654	4030011600	S.CERAMIC C1608 JB 1E 104K-T	T
C655	4030011600	S.CERAMIC C1608 JB 1E 104K-T	T
C656	4550006820	S.TANTALUM ECST1DX106R	B
C657	4030018510	S.CERAMIC C2012 CH 1H 682J-T	T
C658	4030007050	S.CERAMIC C1608 CH 1H 220J-T	T
C701	4030017840	S.CERAMIC C2012 CH 1H 222J-T	T
C702	4030017840	S.CERAMIC C2012 CH 1H 222J-T	T
C703	4550006820	S.TANTALUM ECST1DX106R	B
C704	4030011600	S.CERAMIC C1608 JB 1E 104K-T	T
C705	4030011600	S.CERAMIC C1608 JB 1E 104K-T	T
C706	4550006820	S.TANTALUM ECST1DX106R	B
C707	4030007050	S.CERAMIC C1608 CH 1H 220J-T	T
C771	4550006200	S.TANTALUM ECST0JY106R	B
C772	4030011600	S.CERAMIC C1608 JB 1E 104K-T	T
C773	4550006200	S.TANTALUM ECST0JY106R	B
C801	4030011600	S.CERAMIC C1608 JB 1E 104K-T	T
C921	4550006210	S.TANTALUM ECST1CX106R	B
C922	4030011600	S.CERAMIC C1608 JB 1E 104K-T	T
C923	4550002830	S.TANTALUM TEESVD2 1V 685M12R	B
C924	4030011600	S.CERAMIC C1608 JB 1E 104K-T	T
C925	4550006210	S.TANTALUM ECST1CX106R	B
C926	4030011600	S.CERAMIC C1608 JB 1E 104K-T	T
C927	4550002830	S.TANTALUM TEESVD2 1V 685M12R	B
C928	4030011600	S.CERAMIC C1608 JB 1E 104K-T	T
C961	4030011600	S.CERAMIC C1608 JB 1E 104K-T	B
C962	4550006700	S.TANTALUM ECST1AY106R	B
C963	4030011600	S.CERAMIC C1608 JB 1E 104K-T	B
C964	4550006700	S.TANTALUM ECST1AY106R	B
J201	6510024450	S.CONNECTOR IC197-3202-2000	B
J921	6910013900	CONNECTOR IMSA-9180S-22A	B
J961	6910012460	CONNECTOR IMSA-9180S-30A	B
EP1	0910057622	PCB B 5970B	

[DSP-TX BOARD]

REF NO.	ORDER NO.	DESCRIPTION	M.
IC1	1140011160	S.IC TMS320C6713GDP225	T
IC151	1130008360	S.IC TC7SHU04FU (TE85L)	B
IC171	1130008040	S.IC TC7SH04FU	T
IC181	1130011150	S.IC SN74AHC2G08HDCTR	T
IC191	1130011150	S.IC SN74AHC2G08HDCTR	T
IC201	1130012200	S.IC AT29LV040A-20TC (SX-2590F)	T
IC301	1110006100	S.IC NJM5534MD-TE1	T
IC341	1110006100	S.IC NJM5534MD-TE1	T
IC371	1110006100	S.IC NJM5534MD-TE1	T
IC401	1110006110	S.IC AK5394A-VS	T
IC451	1130006890	S.IC TC7S04FU (TE85R)	T
IC452	1130012160	S.IC SN74LVC1GU04DCKR	T
IC551	1190001170	S.IC AD1855.IRSRL	T
IC601	1110006100	S.IC NJM5534MD-TE1	T
IC651	1110006100	S.IC NJM5534MD-TE1	T
IC701	1110006100	S.IC NJM5534MD-TE1	T
IC801	1110006100	S.IC NJM5534MD-TE1	T
IC831	1110006100	S.IC NJM5534MD-TE1	T
IC871	1110006100	S.IC NJM5534MD-TE1	T
FI101	2040000790	S.LC EXCCET103U	T
X151	6050011660	S.XTAL CR-754 (30.000 MHz)	B
L1	6200003950	S.COIL HF50ACC 322513-T	B
L2	6180003500	S.COIL SLF6028T-100M1R3	B
L3	6200003640	S.COIL MLF1608E 100K-T	B
L401	6200003950	S.COIL HF50ACC 322513-T	T
L921	6200003950	S.COIL HF50ACC 322513-T	T
L922	6200003950	S.COIL HF50ACC 322513-T	T
L924	6200003950	S.COIL HF50ACC 322513-T	T
L925	6200003950	S.COIL HF50ACC 322513-T	T
L961	6200003950	S.COIL HF50ACC 322513-T	B
L962	6200003950	S.COIL HF50ACC 322513-T	B
R1	7030003560	S.RESISTOR ERJ3GEYJ 103 V (10 kΩ)	B
R2	7030003560	S.RESISTOR ERJ3GEYJ 103 V (10 kΩ)	B
R3	7030003560	S.RESISTOR ERJ3GEYJ 103 V (10 kΩ)	B
R4	7030003560	S.RESISTOR ERJ3GEYJ 103 V (10 kΩ)	B
R5	7030003440	S.RESISTOR ERJ3GEYJ 102 V (1 kΩ)	B
R6	7030003440	S.RESISTOR ERJ3GEYJ 102 V (1 kΩ)	B
R7	7030003640	S.RESISTOR ERJ3GEYJ 473 V (47 kΩ)	B
R8	7030003440	S.RESISTOR ERJ3GEYJ 102 V (1 kΩ)	B
R9	7030003640	S.RESISTOR ERJ3GEYJ 473 V (47 kΩ)	B
R10	7030003640	S.RESISTOR ERJ3GEYJ 473 V (47 kΩ)	T
R11	7030003460	S.RESISTOR ERJ3GEYJ 152 V (1.5 kΩ)	B
R151	7030003320	S.RESISTOR ERJ3GEYJ 101 V (100 Ω)	T
R152	7030003800	S.RESISTOR ERJ3GEYJ 105 V (1 MΩ)	B
R171	7030003320	S.RESISTOR ERJ3GEYJ 101 V (100 Ω)	T
R181	7030003560	S.RESISTOR ERJ3GEYJ 103 V (10 kΩ)	T
R182	7030003560	S.RESISTOR ERJ3GEYJ 103 V (10 kΩ)	T
R183	7030003560	S.RESISTOR ERJ3GEYJ 103 V (10 kΩ)	T
R184	7030003560	S.RESISTOR ERJ3GEYJ 103 V (10 kΩ)	T
R301	7030003440	S.RESISTOR ERJ3GEYJ 102 V (1 kΩ)	T
R302	7030009591	S.RESISTOR ERA3YED 472V	T
R303	7030009591	S.RESISTOR ERA3YED 472V	T
R304	7030003320	S.RESISTOR ERJ3GEYJ 101 V (100 Ω)	T
R305	7030003440	S.RESISTOR ERJ3GEYJ 102 V (1 kΩ)	T
R306	7030003320	S.RESISTOR ERJ3GEYJ 101 V (100 Ω)	T
R341	7030003320	S.RESISTOR ERJ3GEYJ 101 V (100 Ω)	T
R342	7030003320	S.RESISTOR ERJ3GEYJ 101 V (100 Ω)	T
R343	7030005321	S.RESISTOR ERA3YED 103V	T
R344	7030009591	S.RESISTOR ERA3YED 472V	T
R345	7030009691	S.RESISTOR ERA3YED 101V (100 Ω)	T
R371	7030003320	S.RESISTOR ERJ3GEYJ 101 V (100 Ω)	B
R372	7030003320	S.RESISTOR ERJ3GEYJ 101 V (100 Ω)	T
R373	7030005321	S.RESISTOR ERA3YED 103V	T
R374	7030009591	S.RESISTOR ERA3YED 472V	T
R375	7030009691	S.RESISTOR ERA3YED 101V (100 Ω)	T
R401	7030009591	S.RESISTOR ERA3YED 472V	T
R402	7030009591	S.RESISTOR ERA3YED 472V	T
R403	7030003640	S.RESISTOR ERJ3GEYJ 473 V (47 kΩ)	T
R404	7030003200	S.RESISTOR ERJ3GEYJ 100 V (10 Ω)	T
R405	7030003320	S.RESISTOR ERJ3GEYJ 101 V (100 Ω)	T
R406	7030003640	S.RESISTOR ERJ3GEYJ 473 V (47 kΩ)	T
R407	7030003460	S.RESISTOR ERJ3GEYJ 152 V (1.5 kΩ)	B
R409	7030003640	S.RESISTOR ERJ3GEYJ 473 V (47 kΩ)	T
R410	7030003640	S.RESISTOR ERJ3GEYJ 473 V (47 kΩ)	T
R411	7030003640	S.RESISTOR ERJ3GEYJ 473 V (47 kΩ)	T
R412	7030003520	S.RESISTOR ERJ3GEYJ 472 V (4.7 kΩ)	T
R413	7030003520	S.RESISTOR ERJ3GEYJ 472 V (4.7 kΩ)	T
R414	7030003360	S.RESISTOR ERJ3GEYJ 221 V (220 Ω)	T
R451	7030003800	S.RESISTOR ERJ3GEYJ 105 V (1 MΩ)	T
R551	7030003360	S.RESISTOR ERJ3GEYJ 221 V (220 Ω)	B

M.=Mounted side (T: Mounted on the Top side, B: Mounted on the Bottom side)

S.=Surface mount

[DSP-TX BOARD]

REF NO.	ORDER NO.	DESCRIPTION	M.
R601	7030006521	S.RESISTOR ERA3YED 561V	T
R602	7030007661	S.RESISTOR ERA3YED 331V	T
R603	7030007661	S.RESISTOR ERA3YED 331V	T
R604	7030009961	S.RESISTOR ERA3YED 221V (220 Ω)	T
R605	7030007661	S.RESISTOR ERA3YED 331V	T
R606	7030003320	S.RESISTOR ERJ3GEYJ 101 V (100 Ω)	B
R607	7030003320	S.RESISTOR ERJ3GEYJ 101 V (100 Ω)	B
R651	7030006521	S.RESISTOR ERA3YED 561V	T
R652	7030007661	S.RESISTOR ERA3YED 331V	T
R653	7030007661	S.RESISTOR ERA3YED 331V	T
R654	7030009961	S.RESISTOR ERA3YED 221V (220 Ω)	T
R655	7030007661	S.RESISTOR ERA3YED 331V	T
R656	7030003320	S.RESISTOR ERJ3GEYJ 101 V (100 Ω)	B
R657	7030003320	S.RESISTOR ERJ3GEYJ 101 V (100 Ω)	B
R701	7030010770	S.RESISTOR ERA3YED 681V (680 Ω)	T
R702	7030009861	S.RESISTOR ERA3YED 471V	T
R703	7030010770	S.RESISTOR ERA3YED 681V (680 Ω)	T
R704	7030009861	S.RESISTOR ERA3YED 471V	T
R705	7030009691	S.RESISTOR ERA3YED 101V (100 Ω)	T
R706	7030003320	S.RESISTOR ERJ3GEYJ 101 V (100 Ω)	B
R707	7030003320	S.RESISTOR ERJ3GEYJ 101 V (100 Ω)	B
R801	7030009591	S.RESISTOR ERA3YED 472V	T
R802	7030003320	S.RESISTOR ERJ3GEYJ 101 V (100 Ω)	T
R803	7030005321	S.RESISTOR ERA3YED 103V	T
R804	7030003320	S.RESISTOR ERJ3GEYJ 101 V (100 Ω)	B
R805	7030003320	S.RESISTOR ERJ3GEYJ 101 V (100 Ω)	B
R831	7030009591	S.RESISTOR ERA3YED 472V	T
R832	7030003320	S.RESISTOR ERJ3GEYJ 101 V (100 Ω)	T
R833	7030005321	S.RESISTOR ERA3YED 103V	T
R834	7030003320	S.RESISTOR ERJ3GEYJ 101 V (100 Ω)	B
R835	7030003320	S.RESISTOR ERJ3GEYJ 101 V (100 Ω)	B
R871	7030003520	S.RESISTOR ERJ3GEYJ 472 V (4.7 kΩ)	T
R872	7030003520	S.RESISTOR ERJ3GEYJ 472 V (4.7 kΩ)	T
R874	7030003320	S.RESISTOR ERJ3GEYJ 101 V (100 Ω)	B
R875	7030003320	S.RESISTOR ERJ3GEYJ 101 V (100 Ω)	B
R901	7030003860	S.RESISTOR ERJ3GE JPW V	B
R903	7030003860	S.RESISTOR ERJ3GE JPW V	B
R904	7030003860	S.RESISTOR ERJ3GE JPW V	B
R905	7030003860	S.RESISTOR ERJ3GE JPW V	B
R962	7030003320	S.RESISTOR ERJ3GEYJ 101 V (100 Ω)	T
R963	7030003320	S.RESISTOR ERJ3GEYJ 101 V (100 Ω)	T
R964	7030003320	S.RESISTOR ERJ3GEYJ 101 V (100 Ω)	T
R967	7030003320	S.RESISTOR ERJ3GEYJ 101 V (100 Ω)	T
R968	7030003320	S.RESISTOR ERJ3GEYJ 101 V (100 Ω)	T
R969	7030003320	S.RESISTOR ERJ3GEYJ 101 V (100 Ω)	T
R970	7030003320	S.RESISTOR ERJ3GEYJ 101 V (100 Ω)	T
R971	7030003320	S.RESISTOR ERJ3GEYJ 101 V (100 Ω)	T
R972	7030003320	S.RESISTOR ERJ3GEYJ 101 V (100 Ω)	T
R973	7030003320	S.RESISTOR ERJ3GEYJ 101 V (100 Ω)	T
R974	7030003320	S.RESISTOR ERJ3GEYJ 101 V (100 Ω)	T
R975	7030003320	S.RESISTOR ERJ3GEYJ 101 V (100 Ω)	T
R976	7030003320	S.RESISTOR ERJ3GEYJ 101 V (100 Ω)	T
C1	4030011600	S.CERAMIC C1608 JB 1E 104K-T	B
C2	4030011600	S.CERAMIC C1608 JB 1E 104K-T	B
C3	4030011600	S.CERAMIC C1608 JB 1E 104K-T	B
C4	4030011600	S.CERAMIC C1608 JB 1E 104K-T	B
C5	4030011600	S.CERAMIC C1608 JB 1E 104K-T	B
C6	4030011600	S.CERAMIC C1608 JB 1E 104K-T	B
C7	4030011600	S.CERAMIC C1608 JB 1E 104K-T	B
C8	4030011600	S.CERAMIC C1608 JB 1E 104K-T	B
C9	4030011600	S.CERAMIC C1608 JB 1E 104K-T	B
C10	4030011600	S.CERAMIC C1608 JB 1E 104K-T	B
C11	4030011600	S.CERAMIC C1608 JB 1E 104K-T	B
C12	4030011600	S.CERAMIC C1608 JB 1E 104K-T	T
C13	4030011600	S.CERAMIC C1608 JB 1E 104K-T	B
C14	4030011600	S.CERAMIC C1608 JB 1E 104K-T	B
C15	4030011600	S.CERAMIC C1608 JB 1E 104K-T	B
C16	4030011600	S.CERAMIC C1608 JB 1E 104K-T	B
C17	4030011600	S.CERAMIC C1608 JB 1E 104K-T	T
C18	4030011600	S.CERAMIC C1608 JB 1E 104K-T	B
C19	4030011600	S.CERAMIC C1608 JB 1E 104K-T	B
C20	4030011600	S.CERAMIC C1608 JB 1E 104K-T	B
C21	4030011600	S.CERAMIC C1608 JB 1E 104K-T	B
C22	4030011600	S.CERAMIC C1608 JB 1E 104K-T	B
C23	4030011600	S.CERAMIC C1608 JB 1E 104K-T	B
C24	4030011600	S.CERAMIC C1608 JB 1E 104K-T	B
C25	4030011600	S.CERAMIC C1608 JB 1E 104K-T	B
C26	4030011600	S.CERAMIC C1608 JB 1E 104K-T	B
C27	4030011600	S.CERAMIC C1608 JB 1E 104K-T	B
C28	4030011600	S.CERAMIC C1608 JB 1E 104K-T	B
C29	4030011600	S.CERAMIC C1608 JB 1E 104K-T	B
C30	4030011600	S.CERAMIC C1608 JB 1E 104K-T	T
C31	4030011600	S.CERAMIC C1608 JB 1E 104K-T	T
C32	4030011600	S.CERAMIC C1608 JB 1E 104K-T	T
C33	4030011600	S.CERAMIC C1608 JB 1E 104K-T	T
C34	4030011600	S.CERAMIC C1608 JB 1E 104K-T	T

M.=Mounted side (T: Mounted on the Top side, B: Mounted on the Bottom side)

[DSP-TX BOARD]

REF NO.	ORDER NO.	DESCRIPTION	M.
C35	4030011600	S.CERAMIC C1608 JB 1E 104K-T	B
C36	4030011600	S.CERAMIC C1608 JB 1E 104K-T	B
C37	4030011600	S.CERAMIC C1608 JB 1E 104K-T	B
C38	4030011600	S.CERAMIC C1608 JB 1E 104K-T	B
C39	4030011600	S.CERAMIC C1608 JB 1E 104K-T	B
C40	4030011600	S.CERAMIC C1608 JB 1E 104K-T	B
C41	4030011600	S.CERAMIC C1608 JB 1E 104K-T	B
C42	4030011600	S.CERAMIC C1608 JB 1E 104K-T	B
C43	4030011600	S.CERAMIC C1608 JB 1E 104K-T	B
C44	4030011600	S.CERAMIC C1608 JB 1E 104K-T	B
C45	4030011600	S.CERAMIC C1608 JB 1E 104K-T	B
C46	4030011600	S.CERAMIC C1608 JB 1E 104K-T	B
C47	4030011600	S.CERAMIC C1608 JB 1E 104K-T	T
C48	4030011600	S.CERAMIC C1608 JB 1E 104K-T	B
C49	4030011600	S.CERAMIC C1608 JB 1E 104K-T	B
C50	4030011600	S.CERAMIC C1608 JB 1E 104K-T	B
C51	4030011600	S.CERAMIC C1608 JB 1E 104K-T	B
C52	4030011600	S.CERAMIC C1608 JB 1E 104K-T	B
C53	4030011600	S.CERAMIC C1608 JB 1E 104K-T	B
C54	4030011600	S.CERAMIC C1608 JB 1E 104K-T	T
C55	4030011600	S.CERAMIC C1608 JB 1E 104K-T	B
C56	4030011600	S.CERAMIC C1608 JB 1E 104K-T	B
C57	4030011600	S.CERAMIC C1608 JB 1E 104K-T	B
C58	4030011600	S.CERAMIC C1608 JB 1E 104K-T	T
C59	4030011600	S.CERAMIC C1608 JB 1E 104K-T	B
C60	4510007130	S.ELECTROLYTIC EEFCD 0J 470R	B
C61	4550006200	S.TANTALUM ECST0JY106R	B
C62	4510007130	S.ELECTROLYTIC EEFCD 0J 470R	T
C101	4030011600	S.CERAMIC C1608 JB 1E 104K-T	B
C102	4550006200	S.TANTALUM ECST0JY106R	B
C151	4030011600	S.CERAMIC C1608 JB 1E 104K-T	B
C152	4030007030	S.CERAMIC C1608 CH 1H 150J-T	B
C153	4030007030	S.CERAMIC C1608 CH 1H 150J-T	B
C171	4030011600	S.CERAMIC C1608 JB 1E 104K-T	T
C181	4030011600	S.CERAMIC C1608 JB 1E 104K-T	T
C191	4030011600	S.CERAMIC C1608 JB 1E 104K-T	T
C201	4030011600	S.CERAMIC C1608 JB 1E 104K-T	B
C301	4550006450	S.TANTALUM ECST1EY105R	B
C302	4550006820	S.TANTALUM ECST1DX106R	B
C303	4030011600	S.CERAMIC C1608 JB 1E 104K-T	T
C304	4550006820	S.TANTALUM ECST1DX106R	B
C305	4030011600	S.CERAMIC C1608 JB 1E 104K-T	T
C306	4030007050	S.CERAMIC C1608 CH 1H 220J-T	T
C341	4550006820	S.TANTALUM ECST1DX106R	B
C342	4030011600	S.CERAMIC C1608 JB 1E 104K-T	T
C343	4550006820	S.TANTALUM ECST1DX106R	B
C344	4030011600	S.CERAMIC C1608 JB 1E 104K-T	T
C345	4550006450	S.TANTALUM ECST1EY105R	B
C346	4030007140	S.CERAMIC C1608 CH 1H 121J-T	T
C347	4030011600	S.CERAMIC C1608 JB 1E 104K-T	T
C348	4030007050	S.CERAMIC C1608 CH 1H 220J-T	T
C371	4550006820	S.TANTALUM ECST1DX106R	B
C372	4030011600	S.CERAMIC C1608 JB 1E 104K-T	T
C373	4550006820	S.TANTALUM ECST1DX106R	B
C374	4030011600	S.CERAMIC C1608 JB 1E 104K-T	T
C375	4550006450	S.TANTALUM ECST1EY105R	B
C376	4030007140	S.CERAMIC C1608 CH 1H 121J-T	T
C377	4030011600	S.CERAMIC C1608 JB 1E 104K-T	T
C378	4030007050	S.CERAMIC C1608 CH 1H 220J-T	T
C401	4550006200	S.TANTALUM ECST0JY106R	B
C402	4030017840	S.CERAMIC C2012 CH 1H 222J-T	T
C403	4550006200	S.TANTALUM ECST0JY106R	B
C404	4030011810	S.CERAMIC C1608 JB 1A 224K-T	T
C405	4550006200	S.TANTALUM ECST0JY106R	B
C406	4030011810	S.CERAMIC C1608 JB 1A 224K-T	T
C407	4550006200	S.TANTALUM ECST0JY106R	B
C408	4030011600	S.CERAMIC C1608 JB 1E 104K-T	T
C410	4030009000	S.CERAMIC C2012 JB 1C 224K-T	T
C411	4550006200	S.TANTALUM ECST0JY106R	B
C412	4550006200	S.TANTALUM ECST0JY106R	B
C413	4030009000	S.CERAMIC C2012 JB 1C 224K-T	T
C414	4030011600	S.CERAMIC C1608 JB 1E 104K-T	T
C415	4550006700	S.TANTALUM ECST1AY106R	B
C416	4550006200	S.TANTALUM ECST0JY106R	B
C417	4030017840	S.CERAMIC C2012 CH 1H 222J-T	T
C450	4030011600	S.CERAMIC C1608 JB 1E 104K-T	T
C451	4030011600	S.CERAMIC C1608 JB 1E 104K-T	T
C452	4030006860	S.CERAMIC C1608 JB 1H 102K-T	T
C551	4030011600	S.CERAMIC C1608 JB 1E 104K-T	T
C552	4550006700	S.TANTALUM ECST1AY106R	B
C553	4550006700	S.TANTALUM ECST1AY106R	B
C554	4550006700	S.TANTALUM ECST1AY106R	B
C555	4030011600	S.CERAMIC C1608 JB 1E 104K-T	T
C556	4030011600	S.CERAMIC C1608 JB 1E 104K-T	T
C557	4030011600	S.CERAMIC C1608 JB 1E 104K-T	B
C601	4550006450	S.TANTALUM ECST1EY105R	B
C602	4030018510	S.CERAMIC C2012 CH 1H 682J-T	T
C603	4550006820	S.TANTALUM ECST1DX106R	B

S.=Surface mount

[DSP-TX BOARD]

REF NO.	ORDER NO.	DESCRIPTION	M.
C604	4030011600	S.CERAMIC C1608 JB 1E 104K-T	T
C605	4030011600	S.CERAMIC C1608 JB 1E 104K-T	T
C606	4550006820	S.TANTALUM ECST1DX106R	B
C607	4030018510	S.CERAMIC C2012 CH 1H 682J-T	T
C608	4030007050	S.CERAMIC C1608 CH 1H 220J-T	T
C651	4550006450	S.TANTALUM ECST1EY105R	B
C652	4030018510	S.CERAMIC C2012 CH 1H 682J-T	T
C653	4550006820	S.TANTALUM ECST1DX106R	B
C654	4030011600	S.CERAMIC C1608 JB 1E 104K-T	T
C655	4030011600	S.CERAMIC C1608 JB 1E 104K-T	T
C656	4550006820	S.TANTALUM ECST1DX106R	B
C657	4030018510	S.CERAMIC C2012 CH 1H 682J-T	T
C658	4030007050	S.CERAMIC C1608 CH 1H 220J-T	T
C701	4030017840	S.CERAMIC C2012 CH 1H 222J-T	T
C702	4030017840	S.CERAMIC C2012 CH 1H 222J-T	T
C703	4550006820	S.TANTALUM ECST1DX106R	B
C704	4030011600	S.CERAMIC C1608 JB 1E 104K-T	T
C705	4030011600	S.CERAMIC C1608 JB 1E 104K-T	T
C706	4550006820	S.TANTALUM ECST1DX106R	B
C707	4030007050	S.CERAMIC C1608 CH 1H 220J-T	T
C801	4030006860	S.CERAMIC C1608 JB 1H 102K-T	T
C802	4030011600	S.CERAMIC C1608 JB 1E 104K-T	T
C803	4550006200	S.TANTALUM ECST0JY106R	B
C804	4030011600	S.CERAMIC C1608 JB 1E 104K-T	T
C805	4550006700	S.TANTALUM ECST1AY106R	B
C806	4030011600	S.CERAMIC C1608 JB 1E 104K-T	T
C807	4550006820	S.TANTALUM ECST1DX106R	B
C808	4030007050	S.CERAMIC C1608 CH 1H 220J-T	T
C831	4030006860	S.CERAMIC C1608 JB 1H 102K-T	T
C832	4030011600	S.CERAMIC C1608 JB 1E 104K-T	T
C833	4550006200	S.TANTALUM ECST0JY106R	B
C834	4030011600	S.CERAMIC C1608 JB 1E 104K-T	T
C835	4550006700	S.TANTALUM ECST1AY106R	B
C836	4030011600	S.CERAMIC C1608 JB 1E 104K-T	T
C837	4550006820	S.TANTALUM ECST1DX106R	B
C838	4030007050	S.CERAMIC C1608 CH 1H 220J-T	T
C871	4550006700	S.TANTALUM ECST1AY106R	B
C872	4030011600	S.CERAMIC C1608 JB 1E 104K-T	T
C873	4550006820	S.TANTALUM ECST1DX106R	B
C874	4030011600	S.CERAMIC C1608 JB 1E 104K-T	T
C875	4030007050	S.CERAMIC C1608 CH 1H 220J-T	T
C921	4550006210	S.TANTALUM ECST1CX106R	B
C922	4030011600	S.CERAMIC C1608 JB 1E 104K-T	T
C923	4550002830	S.TANTALUM TEESVD2 1V 685M12R	B
C924	4030011600	S.CERAMIC C1608 JB 1E 104K-T	T
C925	4550006210	S.TANTALUM ECST1CX106R	B
C926	4030011600	S.CERAMIC C1608 JB 1E 104K-T	T
C927	4550002830	S.TANTALUM TEESVD2 1V 685M12R	B
C928	4030011600	S.CERAMIC C1608 JB 1E 104K-T	T
C961	4030011600	S.CERAMIC C1608 JB 1E 104K-T	B
C962	4550006700	S.TANTALUM ECST1AY106R	B
C963	4030011600	S.CERAMIC C1608 JB 1E 104K-T	B
C964	4550006700	S.TANTALUM ECST1AY106R	B
J201	6510024450	S.CONNECTOR IC197-3202-2000	B
J921	6910013900	CONNECTOR IMSA-9180S-22A	B
J961	6910012460	CONNECTOR IMSA-9180S-30A	B
EP1	0910057652	PCB B 5971B	

[SCOPE UNIT]

REF NO.	ORDER NO.	DESCRIPTION	M.
IC801	1130009230	S.IC LMX2306TMX	T
IC803	1130009690	S.IC TC74HCT7007AF	B
IC820	1190001960	S.IC AD9857AST	T
IC903	1120002920	S.IC ADM202EARN	T
IC904	1130005720	S.IC TC7W04F (TE12L)	T
IC905	1130005251	S.IC TC74HC08AF (TP1)	B
IC906	1130009830	S.IC TC74VHCT04AF	B
Q1	1530002060	S.TRANSISTOR 2SC4081 T106 R	T
Q2	1530003850	S.TRANSISTOR 2SC5551F-TD	T
Q11	1590000680	S.TRANSISTOR DTC114EUA T106	T
Q12	1590000680	S.TRANSISTOR DTC114EUA T106	T
Q31	1590000680	S.TRANSISTOR DTC114EUA T106	T
Q32	1590000680	S.TRANSISTOR DTC114EUA T106	T
Q33	1590000680	S.TRANSISTOR DTC114EUA T106	T
Q101	1530003150	S.TRANSISTOR 2SC4673D-TD	T
Q201	1560000560	S.FET 2SK882-GR (TE85L)	T
Q202	1560000560	S.FET 2SK882-GR (TE85L)	T
Q301	1530003150	S.TRANSISTOR 2SC4673D-TD	T
Q701	1530003220	S.TRANSISTOR 2SC4406-4-TL	T
Q720	1530003220	S.TRANSISTOR 2SC4406-4-TL	T
Q810	1530003220	S.TRANSISTOR 2SC4406-4-TL	T
Q821	1560000330	S.FET 2SK210-GR (TE85R)	T
Q841	1530002060	S.TRANSISTOR 2SC4081 T106 R	T
Q842	1530003430	S.TRANSISTOR 2SC5226-4-TL	T
Q843	1530003430	S.TRANSISTOR 2SC5226-4-TL	T
Q872	1590000680	S.TRANSISTOR DTC114EUA T106	T
Q903	1530002280	S.TRANSISTOR 2SC4081 T106 S	B
Q904	1510000510	S.TRANSISTOR 2SA1576A T106R	B
Q921	1590001330	S.TRANSISTOR DTA114EUA T106	T
Q922	1590000680	S.TRANSISTOR DTC114EUA T106	T
Q923	1590001330	S.TRANSISTOR DTA114EUA T106	T
Q924	1590000680	S.TRANSISTOR DTC114EUA T106	T
D1	1750000970	S.DIODE CPH5513-TL	T
D2	1750000970	S.DIODE CPH5513-TL	T
D3	1750000440	S.DIODE 1SV263-TL	T
D4	1750000430	S.DIODE HSB88WSTR	T
D11	1790000620	S.DIODE MA77 (TX)	T
D12	1790000620	S.DIODE MA77 (TX)	T
D101	1750000430	S.DIODE HSB88WSTR	T
D201	1710000840	S.DIODE 1SR154-400 TE25	B
D401	1790001250	S.DIODE MA2S111-T106	T
D402	1790001250	S.DIODE MA2S111-(TX)	T
D403	1790001250	S.DIODE MA2S111-(TX)	T
D821	1750000680	S.VARICAP 1SV232 (TPH2) / (TPH3)	T
D822	1750000680	S.VARICAP 1SV232 (TPH2) / (TPH3)	T
D902	1750000550	S.DIODE 1SS355 TE-17	B
FI201	2030000290	S.MONOLITH FL-357 (45 MHz)	T
FI501	2040000790	S.LC EXCCET103U	T
L1	6200001830	S.COIL NL 322522T-100J	T
L2	6200001830	S.COIL NL 322522T-100J	T
L3	6200001830	S.COIL NL 322522T-100J	B
L4	6200001830	S.COIL NL 322522T-100J	T
L5	6150004280	COIL LS-484B (C-14927)	T
L6	6150004280	COIL LS-484B (C-14927)	T
L7	6200003260	S.COIL NL 322522T-101J	T
L8	6140003790	COIL LR-442	T
L9	6200001830	S.COIL NL 322522T-100J	T
L10	6200001830	S.COIL NL 322522T-100J	T
L11	6200001830	S.COIL NL 322522T-100J	T
L12	6200010450	S.COIL C2520C-R82G (0.82U)	T
L13	6200010940	S.COIL C2520C-39NG-A	T
L14	6200010860	S.COIL C2520C-R10G (01.U)	T
L31	6200001830	S.COIL NL 322522T-100J	B
L32	6200001830	S.COIL NL 322522T-100J	B
L33	6200001830	S.COIL NL 322522T-100J	B
L34	6200001830	S.COIL NL 322522T-100J	B
L51	6200001830	S.COIL NL 322522T-100J	B
L52	6200001830	S.COIL NL 322522T-100J	B
L53	6200001830	S.COIL NL 322522T-100J	T
L54	6200001830	S.COIL NL 322522T-100J	T
L55	6200003950	S.COIL HF50ACC 322513-T	B
L56	6200003950	S.COIL HF50ACC 322513-T	T
L57	6200003950	S.COIL HF50ACC 322513-T	T
L58	6200003950	S.COIL HF50ACC 322513-T	B
L59	6200003950	S.COIL HF50ACC 322513-T	T
L60	6200003950	S.COIL HF50ACC 322513-T	T
L101	6140003530	COIL LR-395	T
L102	6140003530	COIL LR-395	T
L103	6200003020	S.COIL NL 322522T-R33J-3	T
L104	6200001920	S.COIL ELJNC R15K-F	B

[SCOPE UNIT]

REF NO.	ORDER NO.	DESCRIPTION	M.
IC1	1110006180	S.IC UPG2009TB-E3	T
IC2	1180001770	S.IC TA79L05F (TE12L)	T
IC31	1110006180	S.IC UPG2009TB-E3	T
IC201	1180002650	S.REG SI-3012KS-TL	T
IC401	1110006130	S.IC μPC4094G2-E1	T
IC403	1110006130	S.IC μPC4094G2-E1	T
IC404	1110006130	S.IC μPC4094G2-E1	T
IC405	1110002700	S.IC NJM2904M-TE1	T
IC501	1190002030	S.IC AD7650AST	T
IC502	1130006890	S.IC TC7S04FU (TE85R)	T
IC505	1180002630	S.REG AD1582BRT-REEL7	T
IC601	1140011530	S.IC TMS320C6711CGDP200	T
IC602	1130011930	S.IC SN74LVC1G04DCKR	T
IC603	1130011930	S.IC SN74LVC1G04DCKR	T
IC604	1130008040	S.IC TC7SH04FU	B
IC671	1130012210	S.IC AT49LV001N-90TC (SX-2590G)	T

M.-Mounted side (T: Mounted on the Top side, B: Mounted on the Bottom side)

S.-Surface mount

[SCOPE UNIT]

REF NO.	ORDER NO.	DESCRIPTION	M.
L201	6150004250	COIL LS-471A (C-14922)	T
L202	6150004280	COIL LS-484B (C-14927)	T
L203	6150004280	COIL LS-484B (C-14927)	T
L204	6200001830	S.COIL NL 322522T-100J	B
L205	6200002430	S.COIL NL 252018T-082J	T
L301	6140003530	COIL LR-395	T
L302	6140003530	COIL LR 395	T
L303	6200003040	S.COIL NL 322522T-R68J-3	T
L304	6200001830	S.COIL NL 322522T-100J	B
L401	6200003170	S.COIL NL 322522T-330J	T
L501	6200001830	S.COIL NL 322522T-100J	T
L502	6200001830	S.COIL NL 322522T-100J	B
L551	6180003500	S.COIL SLF6028T-100M1R3	T
L552	6200001830	S.COIL NL 322522T-100J	T
L671	6200001830	S.COIL NL 322522T-100J	T
L701	6200005490	S.COIL NL 322522T-331J	T
L720	6200001830	S.COIL NL 322522T-100J	T
L721	6200001830	S.COIL NL 322522T-100J	T
L722	6200001830	S.COIL NL 322522T-100J	T
L761	6200003010	S.COIL NL 322522T-R27J-3	T
L762	6200003020	S.COIL NL 322522T-R33J-3	T
L763	6200003250	S.COIL NL 322522T-R39J-3	T
L764	6200003250	S.COIL NL 322522T-R39J-3	T
L801	6200005490	S.COIL NL 322522T-331J	T
L802	6200005490	S.COIL NL 322522T-331J	T
L821	6200001830	S.COIL NL 322522T-100J	T
L822	6190001440	COIL E526GN-110504	T
L823	6200001850	S.COIL NL 322522T-5R6J	T
L825	6200003260	S.COIL NL 322522T-101J	T
L841	6200003260	S.COIL NL 322522T-101J	B
L842	6200003030	S.COIL NL 322522T-R47J-3	T
L851	6200003430	S.COIL NL 322522T-R10J	T
L852	6200001470	S.COIL NL 322522T-R12J-3	T
L902	6200003240	S.COIL NL 322522T-221J	T
R1	7030003360	S.RESISTOR ERJ3GEYJ 221 V (220 Ω)	T
R2	7030003480	S.RESISTOR ERJ3GEYJ 222 V (2.2 kΩ)	T
R3	7030003440	S.RESISTOR ERJ3GEYJ 102 V (1 kΩ)	T
R4	7030003460	S.RESISTOR ERJ3GEYJ 152 V (1.5 kΩ)	T
R5	7030003520	S.RESISTOR ERJ3GEYJ 472 V (4.7 kΩ)	T
R6	7030003440	S.RESISTOR ERJ3GEYJ 102 V (1 kΩ)	T
R7	7030003290	S.RESISTOR ERJ3GEYJ 560 V (56 Ω)	T
R8	7030003440	S.RESISTOR ERJ3GEYJ 102 V (1 kΩ)	T
R9	7030003500	S.RESISTOR ERJ3GEYJ 332 V (3.3 kΩ)	T
R11	7310002760	S.TRIMMER RV-152 (RH03A3AJ4X0HA) 223	T
R12	7030003320	S.RESISTOR ERJ3GEYJ 101 V (100 Ω)	T
R14	7030003340	S.RESISTOR ERJ3GEYJ 151 V (150 Ω)	T
R16	7030003440	S.RESISTOR ERJ3GEYJ 102 V (1 kΩ)	T
R17	7030003440	S.RESISTOR ERJ3GEYJ 102 V (1 kΩ)	T
R18	7030003340	S.RESISTOR ERJ3GEYJ 151 V (150 Ω)	T
R20	7030003440	S.RESISTOR ERJ3GEYJ 102 V (1 kΩ)	T
R21	7030003440	S.RESISTOR ERJ3GEYJ 102 V (1 kΩ)	T
R34	7030003440	S.RESISTOR ERJ3GEYJ 102 V (1 kΩ)	T
R35	7030003440	S.RESISTOR ERJ3GEYJ 102 V (1 kΩ)	T
R36	7030003520	S.RESISTOR ERJ3GEYJ 472 V (4.7 kΩ)	T
R37	7030003500	S.RESISTOR ERJ3GEYJ 332 V (3.3 kΩ)	T
R38	7030003520	S.RESISTOR ERJ3GEYJ 472 V (4.7 kΩ)	T
R39	7030003500	S.RESISTOR ERJ3GEYJ 332 V (3.3 kΩ)	T
R51	7030003520	S.RESISTOR ERJ3GEYJ 472 V (4.7 kΩ)	T
R52	7030003520	S.RESISTOR ERJ3GEYJ 472 V (4.7 kΩ)	T
R53	7030003320	S.RESISTOR ERJ3GEYJ 101 V (100 Ω)	B
R54	7030003500	S.RESISTOR ERJ3GEYJ 332 V (3.3 kΩ)	T
R55	7030003500	S.RESISTOR ERJ3GEYJ 332 V (3.3 kΩ)	T
R61	7030003320	S.RESISTOR ERJ3GEYJ 101 V (100 Ω)	B
R62	7030003320	S.RESISTOR ERJ3GEYJ 101 V (100 Ω)	T
R63	7030003320	S.RESISTOR ERJ3GEYJ 101 V (100 Ω)	B
R64	7030003320	S.RESISTOR ERJ3GEYJ 101 V (100 Ω)	T
R65	7030003320	S.RESISTOR ERJ3GEYJ 101 V (100 Ω)	B
R66	7030003320	S.RESISTOR ERJ3GEYJ 101 V (100 Ω)	T
R71	7030003320	S.RESISTOR ERJ3GEYJ 101 V (100 Ω)	B
R72	7030003320	S.RESISTOR ERJ3GEYJ 101 V (100 Ω)	T
R73	7030003320	S.RESISTOR ERJ3GEYJ 101 V (100 Ω)	T
R74	7030003320	S.RESISTOR ERJ3GEYJ 101 V (100 Ω)	B
R75	7030003320	S.RESISTOR ERJ3GEYJ 101 V (100 Ω)	T
R76	7030003320	S.RESISTOR ERJ3GEYJ 101 V (100 Ω)	B
R77	7030003320	S.RESISTOR ERJ3GEYJ 101 V (100 Ω)	T
R81	7030010520	S.RESISTOR ERJ1TYJ 101U (100 Ω)	B
R103	7030003480	S.RESISTOR ERJ3GEYJ 222 V (2.2 kΩ)	T
R104	7030003320	S.RESISTOR ERJ3GEYJ 101 V (100 Ω)	T
R105	7030003370	S.RESISTOR ERJ3GEYJ 271 V (270 Ω)	B
R106	7030003230	S.RESISTOR ERJ3GEYJ 180 V (18 Ω)	B
R107	7030003370	S.RESISTOR ERJ3GEYJ 271 V (270 Ω)	B
R108	7030003370	S.RESISTOR ERJ3GEYJ 271 V (270 Ω)	B
R109	7030003230	S.RESISTOR ERJ3GEYJ 180 V (18 Ω)	B
R110	7030003370	S.RESISTOR ERJ3GEYJ 271 V (270 Ω)	B
R111	7030003550	S.RESISTOR ERJ3GEYJ 822 V (8.2 kΩ)	T
R112	7030003320	S.RESISTOR ERJ3GEYJ 101 V (100 Ω)	T

[SCOPE UNIT]

REF NO.	ORDER NO.	DESCRIPTION	M.
R113	7030003860	S.RESISTOR ERJ3GE JPW V	B
R201	7030003430	S.RESISTOR ERJ3GEYJ 821 V (820 Ω)	T
R202	7030003430	S.RESISTOR ERJ3GEYJ 821 V (820 Ω)	T
R203	7030003280	S.RESISTOR ERJ3GEYJ 470 V (47 Ω)	B
R204	7030003560	S.RESISTOR ERJ3GEYJ 103 V (10 kΩ)	T
R205	7030003280	S.RESISTOR ERJ3GEYJ 470 V (47 Ω)	B
R206	7030003380	S.RESISTOR ERJ3GEYJ 331 V (330 Ω)	B
R207	7030003220	S.RESISTOR ERJ3GEYJ 150 V (15 Ω)	B
R208	7030003380	S.RESISTOR ERJ3GEYJ 331 V (330 Ω)	B
R209	7030003640	S.RESISTOR ERJ3GEYJ 473 V (47 kΩ)	B
R210	7030003600	S.RESISTOR ERJ3GEYJ 223 V (22 kΩ)	T
R301	7030003320	S.RESISTOR ERJ3GEYJ 101 V (100 Ω)	T
R302	7030003370	S.RESISTOR ERJ3GEYJ 271 V (270 Ω)	B
R303	7030003230	S.RESISTOR ERJ3GEYJ 180 V (18 Ω)	B
R304	7030003370	S.RESISTOR ERJ3GEYJ 271 V (270 Ω)	B
R305	7030003320	S.RESISTOR ERJ3GEYJ 101 V (100 Ω)	T
R306	7030003480	S.RESISTOR ERJ3GEYJ 222 V (2.2 kΩ)	T
R307	7030003550	S.RESISTOR ERJ3GEYJ 822 V (8.2 kΩ)	T
R308	7030003340	S.RESISTOR ERJ3GEYJ 151 V (150 Ω)	T
R402	7030003440	S.RESISTOR ERJ3GEYJ 102 V (1 kΩ)	B
R403	7030003440	S.RESISTOR ERJ3GEYJ 102 V (1 kΩ)	B
R404	7030003440	S.RESISTOR ERJ3GEYJ 102 V (1 kΩ)	B
R405	7030003440	S.RESISTOR ERJ3GEYJ 102 V (1 kΩ)	B
R410	7030003560	S.RESISTOR ERJ3GEYJ 103 V (10 kΩ)	T
R411	7030003560	S.RESISTOR ERJ3GEYJ 103 V (10 kΩ)	T
R412	7030003560	S.RESISTOR ERJ3GEYJ 103 V (10 kΩ)	T
R413	7030003730	S.RESISTOR ERJ3GEYJ 274 V (270 kΩ)	T
R414	7030003560	S.RESISTOR ERJ3GEYJ 103 V (10 kΩ)	B
R415	7030003560	S.RESISTOR ERJ3GEYJ 103 V (10 kΩ)	T
R416	7310002820	S.TRIMMER RV-158 (RH03A3AS5) 474	T
R417	7030003630	S.RESISTOR ERJ3GEYJ 393 V (39 kΩ)	T
R418	7030003570	S.RESISTOR ERJ3GEYJ 123 V (12 kΩ)	T
R419	7030003220	S.RESISTOR ERJ3GEYJ 150 V (15 Ω)	T
R420	7030003580	S.RESISTOR ERJ3GEYJ 153 V (15 kΩ)	T
R421	7030003560	S.RESISTOR ERJ3GEYJ 103 V (10 kΩ)	T
R422	7030003560	S.RESISTOR ERJ3GEYJ 103 V (10 kΩ)	T
R423	7030003540	S.RESISTOR ERJ3GEYJ 682 V (6.8 kΩ)	T
R425	7310002740	S.TRIMMER RV-150 (RH03A3A14X0FC) 103	T
R426	7030003560	S.RESISTOR ERJ3GEYJ 103 V (10 kΩ)	T
R427	7030003560	S.RESISTOR ERJ3GEYJ 103 V (10 kΩ)	T
R428	7030003680	S.RESISTOR ERJ3GEYJ 104 V (100 kΩ)	T
R429	7030003650	S.RESISTOR ERJ3GEYJ 563 V (56 kΩ)	T
R430	7030003740	S.RESISTOR ERJ3GEYJ 334 V (330 kΩ)	T
R431	7030003740	S.RESISTOR ERJ3GEYJ 334 V (330 kΩ)	T
R432	7030003640	S.RESISTOR ERJ3GEYJ 473 V (47 kΩ)	T
R433	7030003680	S.RESISTOR ERJ3GEYJ 104 V (100 kΩ)	T
R434	7030003320	S.RESISTOR ERJ3GEYJ 101 V (100 Ω)	T
R435	7030003680	S.RESISTOR ERJ3GEYJ 104 V (100 kΩ)	T
R436	7030003680	S.RESISTOR ERJ3GEYJ 104 V (100 kΩ)	T
R437	7030003680	S.RESISTOR ERJ3GEYJ 104 V (100 kΩ)	T
R438	7030003680	S.RESISTOR ERJ3GEYJ 104 V (100 kΩ)	T
R500	7030003860	S.RESISTOR ERJ3GE JPW V	T
R501	7030003320	S.RESISTOR ERJ3GEYJ 101 V (100 Ω)	T
R502	7030003560	S.RESISTOR ERJ3GEYJ 103 V (10 kΩ)	B
R503	7030003560	S.RESISTOR ERJ3GEYJ 103 V (10 kΩ)	B
R504	7030003560	S.RESISTOR ERJ3GEYJ 103 V (10 kΩ)	T
R505	7030003560	S.RESISTOR ERJ3GEYJ 103 V (10 kΩ)	T
R506	7030003560	S.RESISTOR ERJ3GEYJ 103 V (10 kΩ)	B
R507	7030003320	S.RESISTOR ERJ3GEYJ 101 V (100 Ω)	T
R509	7030003640	S.RESISTOR ERJ3GEYJ 473 V (47 kΩ)	T
R602	7030003560	S.RESISTOR ERJ3GEYJ 103 V (10 kΩ)	B
R603	7030003440	S.RESISTOR ERJ3GEYJ 102 V (1 kΩ)	B
R604	7030003560	S.RESISTOR ERJ3GEYJ 103 V (10 kΩ)	B
R605	7030003560	S.RESISTOR ERJ3GEYJ 103 V (10 kΩ)	B
R606	7030003440	S.RESISTOR ERJ3GEYJ 102 V (1 kΩ)	T
R607	7030003440	S.RESISTOR ERJ3GEYJ 102 V (1 kΩ)	B
R608	7030003440	S.RESISTOR ERJ3GEYJ 102 V (1 kΩ)	B
R609	7030003560	S.RESISTOR ERJ3GEYJ 103 V (10 kΩ)	T
R610	7030003800	S.RESISTOR ERJ3GEYJ 105 V (1 MΩ)	T
R611	7030004040	S.RESISTOR ERJ3GEYJ 4R7 V (4.7 Ω)	T
R612	7030004040	S.RESISTOR ERJ3GEYJ 4R7 V (4.7 Ω)	T
R615	7030003320	S.RESISTOR ERJ3GEYJ 101 V (100 Ω)	T
R616	7030003520	S.RESISTOR ERJ3GEYJ 472 V (4.7 kΩ)	T
R617	7030003520	S.RESISTOR ERJ3GEYJ 472 V (4.7 kΩ)	T
R618	7030003560	S.RESISTOR ERJ3GEYJ 103 V (10 kΩ)	B
R619	7030003560	S.RESISTOR ERJ3GEYJ 103 V (10 kΩ)	B
R620	7030003440	S.RESISTOR ERJ3GEYJ 102 V (1 kΩ)	B
R621	7030003440	S.RESISTOR ERJ3GEYJ 102 V (1 kΩ)	B
R631	7030003860	S.RESISTOR ERJ3GE JPW V	T
R632	7030003860	S.RESISTOR ERJ3GE JPW V	B
R701	7030003240	S.RESISTOR ERJ3GEYJ 220 V (22 Ω)	T
R702	7030003560	S.RESISTOR ERJ3GEYJ 103 V (10 kΩ)	T
R703	7030003320	S.RESISTOR ERJ3GEYJ 101 V (100 Ω)	T
R704	7030003280	S.RESISTOR ERJ3GEYJ 470 V (47 Ω)	T
R705	7030003340	S.RESISTOR ERJ3GEYJ 151 V (150 Ω)	T
R720	7030003370	S.RESISTOR ERJ3GEYJ 271 V (270 Ω)	T
R721	7030003560	S.RESISTOR ERJ3GEYJ 103 V (10 kΩ)	T
R722	7030003340	S.RESISTOR ERJ3GEYJ 151 V (150 Ω)	T

M.-Mounted side (T: Mounted on the Top side, B: Mounted on the Bottom side)

S.-Surface mount

[SCOPE UNIT]

REF NO.	ORDER NO.	DESCRIPTION	M.
R723	7030003440	S.RESISTOR ERJ3GEYJ 102 V (1 kΩ)	B
R724	7030003440	S.RESISTOR ERJ3GEYJ 102 V (1 kΩ)	B
R725	7030003440	S.RESISTOR ERJ3GEYJ 102 V (1 kΩ)	B
R726	7030003440	S.RESISTOR ERJ3GEYJ 102 V (1 kΩ)	B
R727	7030003440	S.RESISTOR ERJ3GEYJ 102 V (1 kΩ)	B
R729	7030003280	S.RESISTOR ERJ3GEYJ 470 V (47 Ω)	T
R730	7030003660	S.RESISTOR ERJ3GEYJ 103 V (10 kΩ)	B
R731	7030003460	S.RESISTOR ERJ3GEYJ 152 V (1.5 kΩ)	T
R732	7030003510	S.RESISTOR ERJ3GEYJ 392 V (3.9 kΩ)	T
R734	7030003510	S.RESISTOR ERJ3GEYJ 392 V (3.9 kΩ)	T
R735	7030003280	S.RESISTOR ERJ3GEYJ 470 V (47 Ω)	T
R736	7030003280	S.RESISTOR ERJ3GEYJ 470 V (47 Ω)	T
R737	7030003440	S.RESISTOR ERJ3GEYJ 102 V (1 kΩ)	T
R738	7030003640	S.RESISTOR ERJ3GEYJ 473 V (47 kΩ)	T
R739	7030003510	S.RESISTOR ERJ3GEYJ 392 V (3.9 kΩ)	T
R741	7030003860	S.RESISTOR ERJ3GE JPW V	B
R742	7030003860	S.RESISTOR ERJ3GE JPW V	T
R744	7030003860	S.RESISTOR ERJ3GE JPW V	T
R745	7030003860	S.RESISTOR ERJ3GE JPW V	T
R748	7030003860	S.RESISTOR ERJ3GE JPW V	T
R764	7030003370	S.RESISTOR ERJ3GEYJ 271 V (270 Ω)	T
R765	7030003230	S.RESISTOR ERJ3GEYJ 180 V (18 Ω)	T
R766	7030003370	S.RESISTOR ERJ3GEYJ 271 V (270 Ω)	T
R767	7030003860	S.RESISTOR ERJ3GE JPW V	T
R771	7030003860	S.RESISTOR ERJ3GE JPW V	T
R801	7030003440	S.RESISTOR ERJ3GEYJ 102 V (1 kΩ)	B
R802	7030003440	S.RESISTOR ERJ3GEYJ 102 V (1 kΩ)	B
R803	7030003440	S.RESISTOR ERJ3GEYJ 102 V (1 kΩ)	B
R806	7030003520	S.RESISTOR ERJ3GEYJ 472 V (4.7 kΩ)	T
R808	7030003600	S.RESISTOR ERJ3GEYJ 223 V (22 kΩ)	T
R809	7030003840	S.RESISTOR ERJ3GEYJ 225 V (2.2 MΩ)	T
R810	7030003370	S.RESISTOR ERJ3GEYJ 271 V (270 Ω)	T
R811	7030003560	S.RESISTOR ERJ3GEYJ 103 V (10 kΩ)	T
R812	7030003280	S.RESISTOR ERJ3GEYJ 470 V (47 Ω)	T
R813	7030003340	S.RESISTOR ERJ3GEYJ 151 V (150 Ω)	T
R814	7030003500	S.RESISTOR ERJ3GEYJ 332 V (3.3 kΩ)	T
R821	7030003680	S.RESISTOR ERJ3GEYJ 104 V (100 kΩ)	T
R822	7030003680	S.RESISTOR ERJ3GEYJ 104 V (100 kΩ)	T
R823	7030003370	S.RESISTOR ERJ3GEYJ 271 V (270 Ω)	T
R841	7030003200	S.RESISTOR ERJ3GEYJ 100 V (10 Ω)	T
R842	7030003360	S.RESISTOR ERJ3GEYJ 221 V (220 Ω)	T
R843	7030003500	S.RESISTOR ERJ3GEYJ 332 V (3.3 kΩ)	T
R844	7030003540	S.RESISTOR ERJ3GEYJ 682 V (6.8 kΩ)	T
R845	7030003360	S.RESISTOR ERJ3GEYJ 221 V (220 Ω)	T
R846	7030003400	S.RESISTOR ERJ3GEYJ 471 V (470 Ω)	T
R847	7030003370	S.RESISTOR ERJ3GEYJ 271 V (270 Ω)	T
R848	7030003540	S.RESISTOR ERJ3GEYJ 682 V (6.8 kΩ)	T
R849	7030003500	S.RESISTOR ERJ3GEYJ 332 V (3.3 kΩ)	T
R850	7030003390	S.RESISTOR ERJ3GEYJ 391 V (390 Ω)	T
R851	7030003360	S.RESISTOR ERJ3GEYJ 221 V (220 Ω)	T
R852	7030003490	S.RESISTOR ERJ3GEYJ 272 V (2.7 kΩ)	T
R853	7030003510	S.RESISTOR ERJ3GEYJ 392 V (3.9 kΩ)	T
R854	7030003360	S.RESISTOR ERJ3GEYJ 221 V (220 Ω)	T
R855	7030009220	S.RESISTOR ERJ12YJ561U	T
R856	7030003370	S.RESISTOR ERJ3GEYJ 271 V (270 Ω)	T
R857	7030003230	S.RESISTOR ERJ3GEYJ 180 V (18 Ω)	T
R858	7030003320	S.RESISTOR ERJ3GEYJ 101 V (100 Ω)	T
R859	7030003260	S.RESISTOR ERJ3GEYJ 330 V (33 Ω)	T
R860	7030003400	S.RESISTOR ERJ3GEYJ 471 V (470 Ω)	T
R861	7030003860	S.RESISTOR ERJ3GE JPW V	T
R905	7030003620	S.RESISTOR ERJ3GEYJ 333 V (33 kΩ)	B
R906	7030003540	S.RESISTOR ERJ3GEYJ 682 V (6.8 kΩ)	B
R907	7030003580	S.RESISTOR ERJ3GEYJ 153 V (15 kΩ)	B
R908	7030003640	S.RESISTOR ERJ3GEYJ 473 V (47 kΩ)	B
R913	7030003370	S.RESISTOR ERJ3GEYJ 271 V (270 Ω)	T
R914	7030003370	S.RESISTOR ERJ3GEYJ 271 V (270 Ω)	T
R951	7030003860	S.RESISTOR ERJ3GE JPW V	B
R952	7030003860	S.RESISTOR ERJ3GE JPW V	B
R953	7030003860	S.RESISTOR ERJ3GE JPW V	B
R954	7030003860	S.RESISTOR ERJ3GE JPW V	B
R955	7030003860	S.RESISTOR ERJ3GE JPW V	T
R956	7030003860	S.RESISTOR ERJ3GE JPW V	T
C1	4030006880	S.CERAMIC C1608 JB 1H 472K-T	T
C2	4030006880	S.CERAMIC C1608 JB 1H 472K-T	T
C3	4030006880	S.CERAMIC C1608 JB 1H 472K-T	T
C4	4030011340	S.CERAMIC C1608 CH 1H 471J-T	T
C5	4030011340	S.CERAMIC C1608 CH 1H 471J-T	T
C6	4030006880	S.CERAMIC C1608 JB 1H 472K-T	T
C7	4030006880	S.CERAMIC C1608 JB 1H 472K-T	T
C8	4030006880	S.CERAMIC C1608 JB 1H 472K-T	T
C9	4030006880	S.CERAMIC C1608 JB 1H 472K-T	T
C10	4030011600	S.CERAMIC C1608 JB 1E 104K-T	T
C11	4030009510	S.CERAMIC C1608 CH 1H 010B-T	B
C12	4030007040	S.CERAMIC C1608 CH 1H 180J-T	T
C13	4030007040	S.CERAMIC C1608 CH 1H 180J-T	B
C14	4030011340	S.CERAMIC C1608 CH 1H 471J-T	B

[SCOPE UNIT]

REF NO.	ORDER NO.	DESCRIPTION	M.
C15	4030006880	S.CERAMIC C1608 JB 1H 472K-T	T
C16	4030006880	S.CERAMIC C1608 JB 1H 472K-T	T
C17	4030006880	S.CERAMIC C1608 JB 1H 472K-T	B
C18	4030006960	S.CERAMIC C1608 CH 1H 050C-T	T
C21	4030006880	S.CERAMIC C1608 JB 1H 472K-T	T
C22	4030006880	S.CERAMIC C1608 JB 1H 472K-T	B
C23	4030011600	S.CERAMIC C1608 JB 1E 104K-T	T
C24	4030006880	S.CERAMIC C1608 JB 1H 472K-T	T
C31	4030006880	S.CERAMIC C1608 JB 1H 472K-T	T
C32	4030006880	S.CERAMIC C1608 JB 1H 472K-T	T
C33	4030006880	S.CERAMIC C1608 JB 1H 472K-T	T
C34	4030006880	S.CERAMIC C1608 JB 1H 472K-T	T
C35	4030006900	S.CERAMIC C1608 JB 1H 103K-T	T
C36	4030006900	S.CERAMIC C1608 JB 1H 103K-T	T
C37	4030006900	S.CERAMIC C1608 JB 1H 103K-T	T
C38	4030006900	S.CERAMIC C1608 JB 1H 103K-T	T
C39	4030006860	S.CERAMIC C1608 JB 1H 102K-T	T
C40	4030006860	S.CERAMIC C1608 JB 1H 102K-T	T
C41	4610001830	S.TRIMMER TZB4S100AB10R00	T
C42	4030007030	S.CERAMIC C1608 CH 1H 150J-T	T
C43	4030007120	S.CERAMIC C1608 CH 1H 820J-T	T
C44	4030007100	S.CERAMIC C1608 CH 1H 560J-T	T
C45	4030007040	S.CERAMIC C1608 CH 1H 180J-T	T
C46	4030008750	S.CERAMIC C1608 CH 1H 360J-T	T
C51	4030006860	S.CERAMIC C1608 JB 1H 102K-T	T
C52	4030006860	S.CERAMIC C1608 JB 1H 102K-T	T
C53	4510004630	S.ELECTROLYTIC ECEV1CA100SR	T
C54	4510004630	S.ELECTROLYTIC ECEV1CA100SR	T
C55	4030011600	S.CERAMIC C1608 JB 1E 104K-T	T
C56	4510004630	S.ELECTROLYTIC ECEV1CA100SR	T
C57	4030011600	S.CERAMIC C1608 JB 1E 104K-T	T
C101	4030006880	S.CERAMIC C1608 JB 1H 472K-T	T
C102	4030007150	S.CERAMIC C1608 CH 1H 151J-T	T
C103	4030011600	S.CERAMIC C1608 JB 1E 104K-T	T
C106	4030006880	S.CERAMIC C1608 JB 1H 472K-T	T
C107	4030007100	S.CERAMIC C1608 CH 1H 560J-T	T
C108	4030007110	S.CERAMIC C1608 CH 1H 680J-T	B
C109	4030007140	S.CERAMIC C1608 CH 1H 121J-T	B
C110	4030007110	S.CERAMIC C1608 CH 1H 680J-T	B
C201	4030007040	S.CERAMIC C1608 CH 1H 180J-T	T
C202	4030007040	S.CERAMIC C1608 CH 1H 180J-T	T
C204	4030006880	S.CERAMIC C1608 JB 1H 472K-T	T
C205	4030007070	S.CERAMIC C1608 CH 1H 330J-T	B
C206	4030006880	S.CERAMIC C1608 JB 1H 472K-T	T
C207	4030006960	S.CERAMIC C1608 CH 1H 050C-T	T
C208	4030007070	S.CERAMIC C1608 CH 1H 330J-T	B
C209	4030006880	S.CERAMIC C1608 JB 1H 472K-T	T
C210	4030011600	S.CERAMIC C1608 JB 1E 104K-T	B
C211	4030009550	S.CERAMIC C1608 CH 1H 2R5B-T	T
C212	4030006940	S.CERAMIC C1608 CH 1H 030C-T	T
C213	4550006620	S.TANTALUM ECST0JY226R	T
C214	4550006620	S.TANTALUM ECST0JY226R	B
C215	4030011600	S.CERAMIC C1608 JB 1E 104K-T	T
C216	4030017490	S.CERAMIC C1608 JB 1A 105K-T	T
C301	4030007040	S.CERAMIC C1608 CH 1H 180J-T	T
C302	4030006880	S.CERAMIC C1608 JB 1H 472K-T	T
C303	4030006880	S.CERAMIC C1608 JB 1H 472K-T	T
C304	4030006880	S.CERAMIC C1608 JB 1H 472K-T	T
C401	4030008850	S.CERAMIC C1608 JB 1H 123K-T	T
C403	4030018610	S.CERAMIC C1608 CH 1H 182J-T	B
C404	4030018580	S.CERAMIC C1608 CH 1H 821J-T	T
C405	4030007140	S.CERAMIC C1608 CH 1H 121J-T	T
C406	4030017840	S.CERAMIC C2012 CH 1H 222J-T	B
C407	4030017840	S.CERAMIC C2012 CH 1H 222J-T	B
C408	4030007010	S.CERAMIC C1608 CH 1H 100D-T	T
C409	4030007140	S.CERAMIC C1608 CH 1H 121J-T	T
C410	4030011600	S.CERAMIC C1608 JB 1E 104K-T	T
C411	4030011600	S.CERAMIC C1608 JB 1E 104K-T	T
C420	4030011600	S.CERAMIC C1608 JB 1E 104K-T	T
C421	4030006920	S.CERAMIC C1608 CH 1H 010C-T	T
C422	4030006920	S.CERAMIC C1608 CH 1H 010C-T	T
C423	4030011600	S.CERAMIC C1608 JB 1E 104K-T	T
C424	4030011600	S.CERAMIC C1608 JB 1E 104K-T	T
C425	4030011600	S.CERAMIC C1608 JB 1E 104K-T	T
C426	4030006900	S.CERAMIC C1608 JB 1H 103K-T	T
C427	4030011600	S.CERAMIC C1608 JB 1E 104K-T	T
C428	4510004440	S.ELECTROLYTIC ECEV1HA010SR	T
C429	4030011600	S.CERAMIC C1608 JB 1E 104K-T	T
C431	4030006900	S.CERAMIC C1608 JB 1H 103K-T	T
C432	4030011600	S.CERAMIC C1608 JB 1E 104K-T	T
C433	4510006220	S.ELECTROLYTIC ECEV1CA101UP	T
C434	4030011600	S.CERAMIC C1608 JB 1E 104K-T	T
C501	4030011600	S.CERAMIC C1608 JB 1E 104K-T	T
C502	4510004630	S.ELECTROLYTIC ECEV1CA100SR	T
C503	4510004630	S.ELECTROLYTIC ECEV1CA100SR	T
C504	4030011600	S.CERAMIC C1608 JB 1E 104K-T	T
C505	4510004630	S.ELECTROLYTIC ECEV1CA100SR	T
C506	4030011600	S.CERAMIC C1608 JB 1E 104K-T	T

M.=Mounted side (T: Mounted on the Top side, B: Mounted on the Bottom side)

S.=Surface mount

[SCOPE UNIT]

REF NO.	ORDER NO.	DESCRIPTION	M.
C507	4510004540	S.ELECTROLYTIC ECEV0JA470SR	T
C508	4030017490	S.CERAMIC C1608 JB 1A 105K-T	T
C509	4030011600	S.CERAMIC C1608 JB 1E 104K-T	T
C521	4510004650	S.ELECTROLYTIC ECEV1EA4R7SR	T
C522	4030011600	S.CERAMIC C1608 JB 1E 104K-T	T
C523	4510004440	S.ELECTROLYTIC ECEV1HA010SR	T
C524	4030011600	S.CERAMIC C1608 JB 1E 104K-T	T
C551	4510004630	S.ELECTROLYTIC ECEV1CA100SR	T
C601	4030011600	S.CERAMIC C1608 JB 1E 104K-T	B
C602	4030011600	S.CERAMIC C1608 JB 1E 104K-T	B
C603	4030011600	S.CERAMIC C1608 JB 1E 104K-T	B
C604	4030011600	S.CERAMIC C1608 JB 1E 104K-T	B
C605	4030011600	S.CERAMIC C1608 JB 1E 104K-T	B
C606	4030011600	S.CERAMIC C1608 JB 1E 104K-T	B
C607	4030011600	S.CERAMIC C1608 JB 1E 104K-T	B
C608	4030011600	S.CERAMIC C1608 JB 1E 104K-T	B
C609	4030011600	S.CERAMIC C1608 JB 1E 104K-T	B
C610	4030011600	S.CERAMIC C1608 JB 1E 104K-T	B
C611	4030011600	S.CERAMIC C1608 JB 1E 104K-T	B
C612	4030011600	S.CERAMIC C1608 JB 1E 104K-T	B
C613	4030011600	S.CERAMIC C1608 JB 1E 104K-T	B
C614	4030011600	S.CERAMIC C1608 JB 1E 104K-T	B
C615	4030011600	S.CERAMIC C1608 JB 1E 104K-T	B
C616	4030011600	S.CERAMIC C1608 JB 1E 104K-T	B
C617	4030011600	S.CERAMIC C1608 JB 1E 104K-T	T
C618	4030011600	S.CERAMIC C1608 JB 1E 104K-T	B
C619	4030011600	S.CERAMIC C1608 JB 1E 104K-T	B
C620	4030011600	S.CERAMIC C1608 JB 1E 104K-T	B
C621	4030011600	S.CERAMIC C1608 JB 1E 104K-T	B
C622	4030011600	S.CERAMIC C1608 JB 1E 104K-T	B
C623	4030011600	S.CERAMIC C1608 JB 1E 104K-T	B
C624	4030011600	S.CERAMIC C1608 JB 1E 104K-T	B
C625	4030011600	S.CERAMIC C1608 JB 1E 104K-T	B
C626	4030011600	S.CERAMIC C1608 JB 1E 104K-T	B
C627	4030011600	S.CERAMIC C1608 JB 1E 104K-T	B
C628	4030011600	S.CERAMIC C1608 JB 1E 104K-T	B
C629	4030011600	S.CERAMIC C1608 JB 1E 104K-T	B
C630	4030011600	S.CERAMIC C1608 JB 1E 104K-T	T
C631	4030011600	S.CERAMIC C1608 JB 1E 104K-T	T
C632	4030011600	S.CERAMIC C1608 JB 1E 104K-T	T
C633	4030011600	S.CERAMIC C1608 JB 1E 104K-T	T
C634	4030011600	S.CERAMIC C1608 JB 1E 104K-T	T
C635	4030011600	S.CERAMIC C1608 JB 1E 104K-T	B
C636	4030011600	S.CERAMIC C1608 JB 1E 104K-T	B
C637	4030011600	S.CERAMIC C1608 JB 1E 104K-T	B
C638	4030011600	S.CERAMIC C1608 JB 1E 104K-T	B
C639	4030011600	S.CERAMIC C1608 JB 1E 104K-T	B
C640	4030011600	S.CERAMIC C1608 JB 1E 104K-T	B
C641	4030011600	S.CERAMIC C1608 JB 1E 104K-T	B
C642	4030011600	S.CERAMIC C1608 JB 1E 104K-T	B
C643	4030011600	S.CERAMIC C1608 JB 1E 104K-T	B
C644	4030011600	S.CERAMIC C1608 JB 1E 104K-T	B
C645	4030011600	S.CERAMIC C1608 JB 1E 104K-T	B
C646	4030011600	S.CERAMIC C1608 JB 1E 104K-T	B
C647	4030011600	S.CERAMIC C1608 JB 1E 104K-T	T
C648	4030011600	S.CERAMIC C1608 JB 1E 104K-T	T
C649	4030011600	S.CERAMIC C1608 JB 1E 104K-T	B
C650	4030011600	S.CERAMIC C1608 JB 1E 104K-T	B
C651	4030011600	S.CERAMIC C1608 JB 1E 104K-T	B
C652	4030011600	S.CERAMIC C1608 JB 1E 104K-T	B
C653	4030011600	S.CERAMIC C1608 JB 1E 104K-T	B
C654	4030011600	S.CERAMIC C1608 JB 1E 104K-T	T
C655	4030011600	S.CERAMIC C1608 JB 1E 104K-T	B
C656	4030011600	S.CERAMIC C1608 JB 1E 104K-T	B
C657	4030011600	S.CERAMIC C1608 JB 1E 104K-T	B
C658	4030011600	S.CERAMIC C1608 JB 1E 104K-T	B
C659	4030011600	S.CERAMIC C1608 JB 1E 104K-T	B
C660	4510004630	S.ELECTROLYTIC ECEV1CA100SR	T
C661	4030011600	S.CERAMIC C1608 JB 1E 104K-T	B
C662	4030011600	S.CERAMIC C1608 JB 1E 104K-T	T
C663	4030011600	S.CERAMIC C1608 JB 1E 104K-T	T
C664	4030011600	S.CERAMIC C1608 JB 1E 104K-T	T
C671	4030011600	S.CERAMIC C1608 JB 1E 104K-T	T
C672	4030006880	S.CERAMIC C1608 JB 1H 472K-T	T
C701	4030011600	S.CERAMIC C1608 JB 1E 104K-T	T
C702	4030011600	S.CERAMIC C1608 JB 1E 104K-T	T
C703	4030011600	S.CERAMIC C1608 JB 1E 104K-T	T
C720	4030006880	S.CERAMIC C1608 JB 1H 472K-T	T
C721	4030011600	S.CERAMIC C1608 JB 1E 104K-T	T
C722	4510004630	S.ELECTROLYTIC ECEV1CA100SR	T
C723	4030006880	S.CERAMIC C1608 JB 1H 472K-T	T
C724	4030011600	S.CERAMIC C1608 JB 1E 104K-T	T
C725	4510004630	S.ELECTROLYTIC ECEV1CA100SR	T
C726	4030006880	S.CERAMIC C1608 JB 1H 472K-T	T
C727	4030006880	S.CERAMIC C1608 JB 1H 472K-T	T
C730	4030011600	S.CERAMIC C1608 JB 1E 104K-T	T
C731	4030011600	S.CERAMIC C1608 JB 1E 104K-T	T
C733	4030011600	S.CERAMIC C1608 JB 1E 104K-T	T

[SCOPE UNIT]

REF NO.	ORDER NO.	DESCRIPTION	M.
C734	4030011600	S.CERAMIC C1608 JB 1E 104K-T	T
C736	4030011600	S.CERAMIC C1608 JB 1E 104K-T	T
C737	4030011600	S.CERAMIC C1608 JB 1E 104K-T	T
C738	4030011600	S.CERAMIC C1608 JB 1E 104K-T	T
C739	4030011600	S.CERAMIC C1608 JB 1E 104K-T	T
C740	4030011600	S.CERAMIC C1608 JB 1E 104K-T	T
C741	4030011600	S.CERAMIC C1608 JB 1E 104K-T	T
C742	4030011600	S.CERAMIC C1608 JB 1E 104K-T	T
C750	4030006900	S.CERAMIC C1608 JB 1H 103K-T	T
C751	4030006900	S.CERAMIC C1608 JB 1H 103K-T	T
C760	4030006880	S.CERAMIC C1608 JB 1H 472K-T	T
C761	4030007150	S.CERAMIC C1608 JB 1H 151J-T	T
C762	4030007110	S.CERAMIC C1608 CH 1H 680J-T	T
C763	4030011280	S.CERAMIC C1608 CH 1H 271J-T	T
C764	4030007080	S.CERAMIC C1608 CH 1H 390J-T	T
C765	4030011830	S.CERAMIC C1608 CH 1H 301J-T	T
C766	4030007020	S.CERAMIC C1608 CH 1H 120J-T	T
C767	4030007170	S.CERAMIC C1608 CH 1H 221J-T	T
C768	4030011280	S.CERAMIC C1608 CH 1H 271J-T	T
C769	4030006860	S.CERAMIC C1608 JB 1H 102K-T	T
C770	4030011280	S.CERAMIC C1608 CH 1H 271J-T	T
C801	4030006880	S.CERAMIC C1608 JB 1H 472K-T	T
C802	4510004630	S.ELECTROLYTIC ECEV1CA100SR	T
C803	4030006900	S.CERAMIC C1608 JB 1H 103K-T	T
C805	4550006450	S.TANTALUM ECST1EY105R	T
C806	4340000240	S.MYLAR ECHU 1C 682JX5	T
C807	4030006880	S.CERAMIC C1608 JB 1H 472K-T	T
C808	4030006880	S.CERAMIC C1608 JB 1H 472K-T	B
C809	4510004630	S.ELECTROLYTIC ECEV1CA100SR	T
C810	4030006880	S.CERAMIC C1608 JB 1H 472K-T	T
C811	4030006880	S.CERAMIC C1608 JB 1H 472K-T	T
C812	4030006880	S.CERAMIC C1608 JB 1H 472K-T	T
C813	4030011600	S.CERAMIC C1608 JB 1E 104K-T	T
C821	4030007060	S.CERAMIC C1608 CH 1H 270J-T	T
C822	4030007100	S.CERAMIC C1608 CH 1H 560J-T	T
C823	4030006960	S.CERAMIC C1608 CH 1H 050C-T	T
C824	4610001850	S.TRIMMER TZB4R200AB10R00	T
C825	4030007130	S.CERAMIC C1608 CH 1H 101J-T	T
C826	4030007060	S.CERAMIC C1608 CH 1H 270J-T	T
C827	4030007020	S.CERAMIC C1608 CH 1H 120J-T	T
C828	4030006880	S.CERAMIC C1608 JB 1H 472K-T	T
C829	4030009500	S.CERAMIC C1608 CH 1H 0R5B-T	T
C830	4030006860	S.CERAMIC C1608 JB 1H 102K-T	T
C831	4030006880	S.CERAMIC C1608 JB 1H 472K-T	T
C832	4510006220	S.ELECTROLYTIC ECEV1CA101UP	T
C833	4510004630	S.ELECTROLYTIC ECEV1CA100SR	T
C842	4030006880	S.CERAMIC C1608 JB 1H 472K-T	T
C843	4030006860	S.CERAMIC C1608 JB 1H 102K-T	T
C844	4030006880	S.CERAMIC C1608 JB 1H 472K-T	T
C845	4510004640	S.ELECTROLYTIC ECEV1CA470SP	T
C846	4030006880	S.CERAMIC C1608 JB 1H 472K-T	T
C847	4030006880	S.CERAMIC C1608 JB 1H 472K-T	T
C848	4030006880	S.CERAMIC C1608 JB 1H 472K-T	T
C849	4030006880	S.CERAMIC C1608 JB 1H 472K-T	T
C850	4030006880	S.CERAMIC C1608 JB 1H 472K-T	T
C851	4030006880	S.CERAMIC C1608 JB 1H 472K-T	T
C852	4030007120	S.CERAMIC C1608 CH 1H 820J-T	T
C853	4030007070	S.CERAMIC C1608 CH 1H 330J-T	T
C854	4030007140	S.CERAMIC C1608 CH 1H 121J-T	T
C855	4030007020	S.CERAMIC C1608 CH 1H 120J-T	T
C856	4030007090	S.CERAMIC C1608 CH 1H 470J-T	T
C862	4030006880	S.CERAMIC C1608 JB 1H 472K-T	T
C911	4030008680	S.CERAMIC C2012 JF 1C 105Z-T	T
C912	4030008680	S.CERAMIC C2012 JF 1C 105Z-T	T
C913	4030008680	S.CERAMIC C2012 JF 1C 105Z-T	T
C914	4030008680	S.CERAMIC C2012 JF 1C 105Z-T	T
C915	4030008680	S.CERAMIC C2012 JF 1C 105Z-T	T
C916	4030011600	S.CERAMIC C1608 JB 1E 104K-T	T
C917	4030011600	S.CERAMIC C1608 JB 1E 104K-T	B
C918	4030011600	S.CERAMIC C1608 JB 1E 104K-T	B
J1	6510007020	CONNECTOR TMP-J01X-V6	T
J2	6510007020	CONNECTOR TMP-J01X-V6	T
J3	6510007020	CONNECTOR TMP-J01X-V6	T
J4	6510020000	S.CONNECTOR 52808-3091	T
J11	6510007020	CONNECTOR TMP-J01X-V6	T
J671	6510024450	S.CONNECTOR IC197-3202-2000	T
J901	6510023720	CONNECTOR LGY6501-0600C	T
J902	6510023120	CONNECTOR CD8109SA1J0 <C>CVI>	T
J903	6510024040	CONNECTOR TM11R-5M2-88-LP	T
J904	6510024030	CONNECTOR UBA-4R-D10T-1	T
J905	6450001940	CONNECTOR KEY-15S-2A3A	T
J906	6510019970	S.CONNECTOR 52808-1091	T
J907	6510020250	S.CONNECTOR B9B-PH-SM3-TB	T
J908	6510022310	S.CONNECTOR B5B-PH-SM3-TB	T
J909	6510003470	CONNECTOR B11B-EH-S	T
J910	6510019420	S.CONNECTOR B8B-ZR-SM3-TF	T

M.=Mounted side (T: Mounted on the Top side, B: Mounted on the Bottom side)

S.=Surface mount

[SCOPE UNIT]

REF NO.	ORDER NO.	DESCRIPTION		M.
DS901	5040002930	S.LED	SML-512MW T86P	T
DS902	5040002930	S.LED	SML-512MW T86P	T
EP1	0910057583	PCB	B 5972C	
EP901	6910012350	S.BEAD	MMZ1608Y 102BT	B
EP902	6910012350	S.BEAD	MMZ1608Y 102BT	B

[LOGIC UNIT]

REF NO.	ORDER NO.	DESCRIPTION		M.
IC1	1140011550	S.IC	MT48LC16M16A2TG-75	B
IC2	1140011550	S.IC	MT48LC16M16A2TG-75	T
IC51	1130011290	S.IC	IDT70V24L25PF	B
IC52	1140011830	S.IC	XC9572XL-10TQ100C (SX2590H)	B
IC53	1110005820	S.IC	R3112N281A-TR	T
IC54	1130007430	S.IC	TC7S14FU (TE85R)	T
IC55	1130008040	S.IC	TC7SH04FU	T
IC56	1130010110	S.IC	TC7WH04FU (TE12L)	B
IC101	1130011010	S.IC	SN74CBTLV3257PWR <WMC>	T
IC102	1130006440	S.IC	TC7S08F (TE85R)	T
IC103	1140011560	S.IC	HD6417751RBP200	T
IC104	1130008360	S.IC	TC7SHU04FU (TE85L)	T
IC105	1130012240	S.IC	CY2292F (SX-2590J)	T
IC106	1130011110	S.IC	TC74VCX04FT (EL)	T
IC201	1140011550	S.IC	MT48LC16M16A2TG-75	B
IC202	1140011550	S.IC	MT48LC16M16A2TG-75	B
IC203	1140011570	S.IC	HD64404BTD	T
IC204	1140011580	S.IC	ADV7123KST50	T
IC205	1130011940	S.IC	TC7SZ04F (TE85L)	T
IC206	1130012150	S.IC	SN74ACT04PWR	T
IC207	1130005720	S.IC	TC7W04F (TE12L)	B
IC208	1130011950	S.IC	μPD16875G-E1	B
IC209	1190001920	S.IC	AK5355-VT-E2	B
IC210	1190001920	S.IC	AK5355-VT-E2	B
IC211	1190001910	S.IC	AK4384-VT-E2	B
IC212	1190001910	S.IC	AK4384-VT-E2	B
IC401	1130010970	S.IC	PCI1410APGE	B
IC402	1130011960	S.IC	TPS2211AIDBR	B
IC403	1130009570	S.IC	BR93LC46F-WE2	T
IC404	1130010990	S.IC	RTL8139C <GMI>	B
IC601	1130008040	S.IC	TC7SH04FU	B
IC602	1130008710	S.IC	TC7SET04FU (TE85L)	B
IC603	1110004770	S.IC	BU9480F-E2	T
IC604	1140011810	S.IC	HD64F2377VFQ33V (SX-2590C)	B
IC605	1140011840	S.IC	XC9572XL-10TQ100C (SX2590I)	B
IC607	1130006440	S.IC	TC7S08F (TE85R)	B
IC608	1130006440	S.IC	TC7S08F (TE85R)	B
IC609	1130005251	S.IC	TC74HC08AF (TP1)	B
IC610	1140008650	S.IC	HN58X2464TI	B
IC801	1180002020	S.REG	BA033FP-E2	B
IC821	1110002700	S.IC	NJM2904M-TE1	B
IC851	1110003870	S.IC	NJM2058M-TE1	B
IC852	1110003870	S.IC	NJM2058M-TE1	B
IC853	1110003870	S.IC	NJM2058M-TE1	B
IC854	1130005720	S.IC	TC7W04F (TE12L)	B
Q601	1530002060	S.TRANSISTOR	2SC4081 T106 R	B
Q602	1510000510	S.TRANSISTOR	2SA1576A T106R	B
Q802	1530002060	S.TRANSISTOR	2SC4081 T106 R	T
Q803	1540000440	S.TRANSISTOR	2SD1619-T-TD	B
Q804	1540000440	S.TRANSISTOR	2SD1619-T-TD	B
Q805	1530002060	S.TRANSISTOR	2SC4081 T106 R	T
Q806	1540000440	S.TRANSISTOR	2SD1619-T-TD	B
Q807	1530002060	S.TRANSISTOR	2SC4081 T106 R	T
Q808	1590001330	S.TRANSISTOR	DTA114EUA T106	B
Q809	1590001330	S.TRANSISTOR	DTA114EUA T106	B
Q810	1540000550	S.TRANSISTOR	2SD1664 T100Q	T
Q821	1520000650	S.TRANSISTOR	2SB1201-S-TL	B
Q822	1530002060	S.TRANSISTOR	2SC4081 T106 R	B
Q901	1590001960	S.TRANSISTOR	XP4311 (TX)	B
Q902	1590001960	S.TRANSISTOR	XP4311 (TX)	B
Q903	1590001960	S.TRANSISTOR	XP4311 (TX)	B
Q904	1590001960	S.TRANSISTOR	XP4311 (TX)	B
D51	1750000550	S.DIODE	1SS355 TE-17 except [FRA]	T
D52	1750000550	S.DIODE	1SS355 TE-17 [FRA], [KOR], [ESP], [UK] only	T

[LOGIC UNIT]

REF NO.	ORDER NO.	DESCRIPTION		M.
D53	1750000550	S.DIODE	1SS355 TE-17 [USA], [EUR], [UK] only	T
D54	1750000550	S.DIODE	1SS355 TE-17 except [FRA]	T
D55	1750000550	S.DIODE	1SS355 TE-17 [EUR], [ITR], [ESP], [UK] only	T
D56	1750000550	S.DIODE	1SS355 TE-17 [FRA], [KOR], [ESP], [UK] only	T
D57	1750000550	S.DIODE	1SS355 TE-17 [USA], [EUR], [UK] only	T
D58	1750000550	S.DIODE	1SS355 TE-17 except [FRA]	T
D59	1750000550	S.DIODE	1SS355 TE-17 [EUR], [ITR], [ESP], [UK] only	T
D60	1750000550	S.DIODE	1SS355 TE-17	T
D61	1750000550	S.DIODE	1SS355 TE-17	T
D62	1750000550	S.DIODE	1SS355 TE-17	T
D65	1750000550	S.DIODE	1SS355 TE-17	T
D66	1750000550	S.DIODE	1SS355 TE-17 [EUR], [FRA], [ITR], [UK] only	T
D67	1750000550	S.DIODE	1SS355 TE-17	T
D68	1750000550	S.DIODE	1SS355 TE-17	T
D201	1790000980	S.DIODE	MA742 (TX)	B
D202	1790000980	S.DIODE	MA742 (TX)	B
D203	1790000980	S.DIODE	MA742 (TX)	B
D204	1790000980	S.DIODE	MA742 (TX)	T
D205	1790000980	S.DIODE	MA742 (TX)	T
D206	1790000980	S.DIODE	MA742 (TX)	B
D207	1790000980	S.DIODE	MA742 (TX)	B
D208	1790000980	S.DIODE	MA742 (TX)	B
D209	1790000980	S.DIODE	MA742 (TX)	B
D601	1750000550	S.DIODE	1SS355 TE-17	B
D801	1750000370	S.DIODE	DA221 TL	B
D802	1750000370	S.DIODE	DA221 TL	B
D803	1750000370	S.DIODE	DA221 TL	B
D804	1750000270	S.DIODE	1SS301 (TE85R)	B
D805	1790001610	S.DIODE	1SS385 (TE85L)	B
D806	1790001610	S.DIODE	1SS385 (TE85L)	B
D821	1730002340	S.ZENER	MA8047-M (TX)	B
D851	1750000550	S.DIODE	1SS355 TE-17	B
D852	1750000550	S.DIODE	1SS355 TE-17	B
D853	1790000980	S.DIODE	MA742 (TX)	B
D854	1790000980	S.DIODE	MA742 (TX)	B
D855	1790000980	S.DIODE	MA742 (TX)	B
D856	1790000980	S.DIODE	MA742 (TX)	B
D857	1750000550	S.DIODE	1SS355 TE-17	B
D858	1750000550	S.DIODE	1SS355 TE-17	B
D860	1790000980	S.DIODE	MA742 (TX)	T
D861	1790000980	S.DIODE	MA742 (TX)	T
D862	1790000980	S.DIODE	MA742 (TX)	T
D863	1790000980	S.DIODE	MA742 (TX)	T
D864	1790000980	S.DIODE	MA742 (TX)	T
D865	1790000980	S.DIODE	MA742 (TX)	T
D866	1790000980	S.DIODE	MA742 (TX)	T
D901	1790000980	S.DIODE	MA742 (TX)	T
X101	6050011610	S.XTAL	CR-751 (25.000 MHz)	T
X201	6050010680	S.XTAL	CR-628 (24.576 MHz)	T
X202	6050011910	S.XTAL	CR-780 (48 MHz)	T
X601	6050011810	S.XTAL	CR-755 (15.9744 MHz)	T
L203	6200002630	S.COIL	NL 252018T-R10J	B
L204	6200002630	S.COIL	NL 252018T-R10J	B
L205	6200002630	S.COIL	NL 252018T-R10J	B
L801	6200003260	S.COIL	NL 322522T-101J	B
L803	6180003320	S.COIL	SLF6028T-150M1R0	B
L804	6180003320	S.COIL	SLF6028T-150M1R0	B
L805	6180003320	S.COIL	SLF6028T-150M1R0	B
L806	6180003320	S.COIL	SLF6028T-150M1R0	B
L807	6180003320	S.COIL	SLF6028T-150M1R0	B
L808	6200003590	S.COIL	EXCCL3225U1	T
L809	6200003590	S.COIL	EXCCL3225U1	B
L810	6200003590	S.COIL	EXCCL3225U1	B
L811	6200001830	S.COIL	NL 322522T-100J	B
L821	6200003590	S.COIL	EXCCL3225U1	B
L822	6200003590	S.COIL	EXCCL3225U1	T
L823	6200009790	S.COIL	BLM31PG121SN1	T
L824	6200003590	S.COIL	EXCCL3225U1	B
L825	6200003590	S.COIL	EXCCL3225U1	B
L826	6180003320	S.COIL	SLF6028T-150M1R0	B
L827	6200003590	S.COIL	EXCCL3225U1	T
L832	6200003590	S.COIL	EXCCL3225U1	B
L833	6200003590	S.COIL	EXCCL3225U1	B
L834	6200003590	S.COIL	EXCCL3225U1	B
L835	6200003590	S.COIL	EXCCL3225U1	B
L901	6200003590	S.COIL	EXCCL3225U1	B
L902	6200003590	S.COIL	EXCCL3225U1	B
L903	6200003590	S.COIL	EXCCL3225U1	B

M.=Mounted side (T: Mounted on the Top side, B: Mounted on the Bottom side)

S.=Surface mount

[LOGIC UNIT]

REF NO.	ORDER NO.	DESCRIPTION		M.
J1	6510022490	S.CONNECTOR	AXK5S30045P	T
J2	6510019870	S.CONNECTOR	AXK5S40045P	T
J51	6910014250	CONNECTOR	IMSA-9202B-2-06	T
J102	6510019980	S.CONNECTOR	52808-1691	T
J602	6510019970	S.CONNECTOR	52808-1091	T
J604	6510019970	S.CONNECTOR	52808-1091	T
J802	6510024260	S.CONNECTOR	S9B-PH-SM3-TB	T
J803	6510024400	CONNECTOR	S11B-EH	T
J804	6510024250	S.CONNECTOR	S6B-PH-SM3-TB	T
J805	6510024110	S.CONNECTOR	52793-2090	T
J806	6510024130	S.CONNECTOR	IMSA-9637S-40Y901	T
J807	6510024150	S.CONNECTOR	50FY-BMT-TB	T
J808	6510022470	S.CONNECTOR	40FLT-SM1-TB	T
J809	6510022470	S.CONNECTOR	40FLT-SM1-TB	T
J810	6510022730	S.CONNECTOR	S13B-PH-SM3-TB	T
J811	6510021560	S.CONNECTOR	52808-2490	T
J812	6510020700	S.CONNECTOR	52793-1290	T
J813	6510020080	S.CONNECTOR	52808-2091	T
J814	6510019970	S.CONNECTOR	52808-1091	T
J815	6510019990	S.CONNECTOR	52808-2291	T
J816	6510019990	S.CONNECTOR	52808-2291	T
J820	6510003580	CONNECTOR	S10B-EH-S	T
J821	6510003550	CONNECTOR	S07B-EH-S	T
J822	6510021600	S.CONNECTOR	S2B-PH-SM3-TB	T
J823	6510021600	S.CONNECTOR	S2B-PH-SM3-TB	T
J824	6510024100	CONNECTOR	SC25-02WVL	T
J825	6510019420	S.CONNECTOR	B8B-ZR-SM3-TF	T
J826	6510023800	S.CONNECTOR	S4B-ZR-SM3A-TF	T
DS401	5040002930	S.LED	SML-512MW T86P	T
DS402	5040002930	S.LED	SML-512MW T86P	T
DS403	5040002930	S.LED	SML-512MW T86P	T
S51	2260001890	S.SWITCH	SKQDPA	T
T401	5920000840	TRANSFORMER	H1102	T
EP1	0910057416	PCB	B 5973F	
EP101	6910013310	S.BEAD	MMZ1608D121B	T
EP102	6910013310	S.BEAD	MMZ1608D121B	T
EP103	6910013310	S.BEAD	MMZ1608D121B	T
EP201	6910012350	S.BEAD	MMZ1608Y 102BT	T
EP202	6910012350	S.BEAD	MMZ1608Y 102BT	T
EP401	6910013310	S.BEAD	MMZ1608D121B	T
EP402	6910013310	S.BEAD	MMZ1608D121B	T
EP403	6910013310	S.BEAD	MMZ1608D121B	T
EP801	6910013310	S.BEAD	MMZ1608D121B	T
EP802	6910013310	S.BEAD	MMZ1608D121B	T
EP803	6910013310	S.BEAD	MMZ1608D121B	T
EP804	6910013310	S.BEAD	MMZ1608D121B	T
EP805	6910013310	S.BEAD	MMZ1608D121B	B
EP806	6910013310	S.BEAD	MMZ1608D121B	T
EP807	6910013310	S.BEAD	MMZ1608D121B	B
EP808	6910013310	S.BEAD	MMZ1608D121B	T
EP809	6910013310	S.BEAD	MMZ1608D121B	B
EP810	6910013310	S.BEAD	MMZ1608D121B	T
EP811	6910013310	S.BEAD	MMZ1608D121B	B
EP812	6910013310	S.BEAD	MMZ1608D121B	B
EP813	6910013310	S.BEAD	MMZ1608D121B	T
EP814	6910013310	S.BEAD	MMZ1608D121B	T
EP815	6910013310	S.BEAD	MMZ1608D121B	T
EP816	6910013310	S.BEAD	MMZ1608D121B	T
EP817	6910013310	S.BEAD	MMZ1608D121B	T
EP818	6910013310	S.BEAD	MMZ1608D121B	T
EP819	6910013310	S.BEAD	MMZ1608D121B	T
EP820	6910013310	S.BEAD	MMZ1608D121B	T
EP972	6910015970	S.BEAD	MMZ1608B 301CT-AS	T
EP973	6910015970	S.BEAD	MMZ1608B 301CT-AS	T
EP996	6910015970	S.BEAD	MMZ1608B 301CT-AS	B
EP997	6910015970	S.BEAD	MMZ1608B 301CT-AS	B
EP1001	6910015970	S.BEAD	MMZ1608B 301CT-AS	B
EP1002	6910015970	S.BEAD	MMZ1608B 301CT-AS	B

M.=Mounted side (T: Mounted on the Top side, B: Mounted on the Bottom side)

[PA UNIT]

REF NO.	ORDER NO.	DESCRIPTION		M.
MF1	2710000770	FAN	FCB34AC12A	
W1	8900012790	CABLE	OPC-1299	

[PA200W BOARD]

REF NO.	ORDER NO.	DESCRIPTION		M.
IC2	1180001540	S.IC	TA78L08F (TE12R)	T
Q1	1520000530	S.TRANSISTOR	2SB1119S-TD	T
Q2	1590000680	S.TRANSISTOR	DTC114EUA T106	T
Q101	1560001240	S.FET	RD01MUS1	T
Q201	1590003050	S.FET	PD55003	T
Q301	1590003350	FET	SD2918	T
Q401	1590003360	FET	SD2931-11	T
Q402	1590003360	FET	SD2931-11	T
D1	1730000560	S.ZENER	RD2.7M-T2B1	T
D401	1750000270	S.DIODE	1SS301 (TE85R)	T
D402	1750000270	S.DIODE	1SS301 (TE85R)	T
D403	1750000270	S.DIODE	1SS301 (TE85R)	T
D404	1750000270	S.DIODE	1SS301 (TE85R)	T
L1	6200000510	S.COIL	NL 252018T-100J	T
L2	6200000510	S.COIL	NL 252018T-100J	T
L3	6200000510	S.COIL	NL 252018T-100J	T
L6	6200000510	S.COIL	NL 252018T-100J	T
L7	6200010880	S.COIL	CDRH124-330MC	T
L101	6200005130	S.COIL	NLC453232T-101K	T
L102	6200007220	S.COIL	EXCC4532U1	T
L201	6180001240	COIL	LAL 04NA 820K	T
L202	6140004350	COIL	LR-475	T
L301	6200003260	S.COIL	NL 322522T-101J	T
L303	6200001830	S.COIL	NL 322522T-100J	T
L304	2040000490	COIL	EXC-ELDR25C	T
L305	2040000490	COIL	EXC-ELDR25C	T
L306	6140004340	COIL	LR-474	T
L307	6200001830	S.COIL	NL 322522T-100J	T
L401	6200003260	S.COIL	NL 322522T-101J	T
L402	6200003260	S.COIL	NL 322522T-101J	T
L403	6140002590	COIL	LR-296 (TR18X8X8 D12A)	T
L404	6140000720	COIL	LR-95	T
L501	6140002030	COIL	LR-230 (SK-10M-15Y 120)	T
R1	7030003440	S.RESISTOR	ERJ3GEYJ 102 V (1 kΩ)	T
R2	7030003560	S.RESISTOR	ERJ3GEYJ 103 V (10 kΩ)	T
R3	7510001740	THERMISTOR	DTN-C103F3H-STS-40	T
R4	7030000380	S.RESISTOR	MCR10EZHJ 1 kΩ	T
R5	7030008061	S.RESISTOR	ERA3YED 222V	T
R6	7030007210	S.RESISTOR	ERA3YEB 102V	T
R7	7030007210	S.RESISTOR	ERA3YEB 102V	T
R101	7030003370	S.RESISTOR	ERJ3GEYJ 271 V (270 Ω)	T
R102	7030003220	S.RESISTOR	ERJ3GEYJ 150 V (15 Ω)	T
R103	7030003370	S.RESISTOR	ERJ3GEYJ 271 V (270 Ω)	T
R104	7030003360	S.RESISTOR	ERJ3GEYJ 221 V (220 Ω)	T
R105	7030003430	S.RESISTOR	ERJ3GEYJ 821 V (820 Ω)	T
R106	7030003480	S.RESISTOR	ERJ3GEYJ 222 V (2.2 kΩ)	T
R107	7030003440	S.RESISTOR	ERJ3GEYJ 102 V (1 kΩ)	T
R108	7030003200	S.RESISTOR	ERJ3GEYJ 100 V (10 Ω)	T
R110	7030000230	S.RESISTOR	MCR10EZHJ 56 Ω (560)	T
R111	7030003420	S.RESISTOR	ERJ3GEYJ 681 V (680 Ω)	T
R112	7030003510	S.RESISTOR	ERJ3GEYJ 392 V (3.9 kΩ)	T
R113	7030003500	S.RESISTOR	ERJ3GEYJ 332 V (3.3 kΩ)	T
R115	7030003520	S.RESISTOR	ERJ3GEYJ 472 V (4.7 kΩ)	T
R117	7030003530	S.RESISTOR	ERJ3GEYJ 562 V (5.6 kΩ)	T
R118	7030003550	S.RESISTOR	ERJ3GEYJ 822 V (8.2 kΩ)	T
R119	7030008240	S.RESISTOR	ERJ12YJ0R00U	T
R201	7030004050	S.RESISTOR	ERJ3GEYJ 1R0 V (1 Ω)	T
R202	7030003410	S.RESISTOR	ERJ3GEYJ 561 V (560 Ω)	T
R203	7030010800	S.RESISTOR	ERJ1TYJ 2R7U (2.7 Ω)	T
R205	7030006260	S.RESISTOR	ERJ12YJ471U (470 Ω)	T
R301	7310004720	TRIMMER	EVM-2AGA00 B24 (203)	T
R302	7030008180	S.RESISTOR	ERJ12YJ331U (330 Ω)	T
R305	7030003530	S.RESISTOR	ERJ3GEYJ 562 V (5.6 kΩ)	T
R307	7070000830	RESISTOR	ERG3SJ 101 (100 Ω)	T
R309	7030010570	S.RESISTOR	ERJ1TYJ 4R7U (4.7 Ω)	T

S.=Surface mount

[PA200W BOARD]

REF NO.	ORDER NO.	DESCRIPTION	M.
R310	7310004710	TRIMMER EVM-2AGA00 B23 (202)	T
R312	7070000830	RESISTOR ERG3SJ 101 (100 Ω)	T
R401	7030010960	S.RESISTOR ERJ1TYJ 120U (12 Ω)	T
R402	7030010960	S.RESISTOR ERJ1TYJ 120U (12 Ω)	T
R403	7030010960	S.RESISTOR ERJ1TYJ 120U (12 Ω)	T
R404	7030010960	S.RESISTOR ERJ1TYJ 120U (12 Ω)	T
R405	7030010960	S.RESISTOR ERJ1TYJ 120U (12 Ω)	T
R406	7030010960	S.RESISTOR ERJ1TYJ 120U (12 Ω)	T
R407	7310004720	TRIMMER EVM-2AGA00 B24 (203)	T
R408	7030000420	S.RESISTOR MCR10EZJH 2.2 kΩ	T
R409	7030000420	S.RESISTOR MCR10EZJH 2.2 kΩ	T
R410	7310004720	TRIMMER EVM-2AGA00 B24 (203)	T
R411	7030010520	S.RESISTOR ERJ1TYJ 101U (100 Ω)	T
R412	7030010520	S.RESISTOR ERJ1TYJ 101U (100 Ω)	T
R413	7030010520	S.RESISTOR ERJ1TYJ 101U (100 Ω)	T
R414	7030010520	S.RESISTOR ERJ1TYJ 101U (100 Ω)	T
R416	7070000890	RESISTOR ERG3SJ 150 (15 Ω)	T
R418	7070001190	RESISTOR ERG3SJ180 (18 Ω)	T
R420	7070000890	RESISTOR ERG3SJ 150 (15 Ω)	T
R422	7070001190	RESISTOR ERG3SJ180 (18 Ω)	T
R423	7030003460	S.RESISTOR ERJ3GEYJ 152 V (1.5 kΩ)	T
R424	7030003460	S.RESISTOR ERJ3GEYJ 152 V (1.5 kΩ)	T
R425	7310004710	TRIMMER EVM-2AGA00 B23 (202)	T
R426	7310004710	TRIMMER EVM-2AGA00 B23 (202)	T
R427	7070001200	RESISTOR ERG3SJ100P (10 Ω)	T
R501	7070000900	RESISTOR ERX3SJ 1R8 (1.8 Ω)	T
R502	7070000900	RESISTOR ERX3SJ 1R8 (1.8 Ω)	T
R503	7030003500	S.RESISTOR ERJ3GEYJ 332 V (3.3 kΩ)	T
R504	7030003500	S.RESISTOR ERJ3GEYJ 332 V (3.3 kΩ)	T
R505	7100000810	S.RESISTOR ERX5WQK 12MH	T
R507	7030003500	S.RESISTOR ERJ3GEYJ 332 V (3.3 kΩ)	T
R508	7030003500	S.RESISTOR ERJ3GEYJ 332 V (3.3 kΩ)	T
R511	7070000900	RESISTOR ERX3SJ 1R8 (1.8 Ω)	T
R512	7070000900	RESISTOR ERX3SJ 1R8 (1.8 Ω)	T
R513	7070001000	RESISTOR ERG3SJ 821 (820 Ω)	T
R514	7070001000	RESISTOR ERG3SJ 821 (820 Ω)	T
C1	4030011600	S.CERAMIC C1608 JB 1E 104K-T	T
C2	4030006880	S.CERAMIC C1608 JB 1H 472K-T	T
C3	4030006880	S.CERAMIC C1608 JB 1H 472K-T	T
C6	4030006880	S.CERAMIC C1608 JB 1H 472K-T	T
C7	4030006900	S.CERAMIC C1608 JB 1H 103K-T	T
C8	4030006880	S.CERAMIC C1608 JB 1H 472K-T	T
C9	4030011600	S.CERAMIC C1608 JB 1E 104K-T	T
C10	4510004640	S.ELECTROLYTIC ECEV1CA470SP	T
C11	4030006900	S.CERAMIC C1608 JB 1H 103K-T	T
C12	4510004640	S.ELECTROLYTIC ECEV1CA470SP	T
C15	4030006880	S.CERAMIC C1608 JB 1H 472K-T	T
C16	4030006880	S.CERAMIC C1608 JB 1H 472K-T	T
C17	4510004440	S.ELECTROLYTIC ECEV1HA010SR	T
C102	4030017810	S.CERAMIC C1608 CH 1H 102J-T	T
C103	4030011600	S.CERAMIC C1608 JB 1E 104K-T	T
C104	4030011600	S.CERAMIC C1608 JB 1E 104K-T	T
C106	4030017320	S.CERAMIC GRM21BB1H104KA11L (GRM40-034)	T
C107	4030011600	S.CERAMIC C1608 JB 1E 104K-T	T
C108	4030017810	S.CERAMIC C1608 CH 1H 102J-T	T
C109	4030017320	S.CERAMIC GRM21BB1H104KA11L (GRM40-034)	T
C110	4030017810	S.CERAMIC C1608 CH 1H 102J-T	T
C111	4030017810	S.CERAMIC C1608 CH 1H 102J-T	T
C112	4030017320	S.CERAMIC GRM21BB1H104KA11L (GRM40-034)	T
C113	4030011600	S.CERAMIC C1608 JB 1E 104K-T	T
C114	4030011600	S.CERAMIC C1608 JB 1E 104K-T	T
C201	4030017320	S.CERAMIC GRM21BB1H104KA11L (GRM40-034)	T
C202	4030017810	S.CERAMIC C1608 CH 1H 102J-T	T
C204	4030008490	S.CERAMIC C2012 JB 1H 682K-T	T
C206	4030008700	S.CERAMIC GRM21B1H473KA01L (GRM40 B)	T
C207	4030008700	S.CERAMIC GRM21B1H473KA01L (GRM40 B)	T
C301	4030004760	S.CERAMIC C2012 JF 1H 104Z-T	T
C303	4030011600	S.CERAMIC C1608 JB 1E 104K-T	T
C305	4030004760	S.CERAMIC C2012 JF 1H 104Z-T	T
C307	4030017810	S.CERAMIC C1608 CH 1H 102J-T	T
C309	4030011600	S.CERAMIC C1608 JB 1E 104K-T	T
C311	4030018750	S.CERAMIC C3225 CH 2J 682K-T	T
C313	4030011600	S.CERAMIC C1608 JB 1E 104K-T	T
C314	4510008050	ELECTROLYTIC 63 MV 220 CZ	T
C317	4030018790	S.CERAMIC C3225 JB 2E 104K-T	T
C318	4030011600	S.CERAMIC C1608 JB 1E 104K-T	T
C319	4030018790	S.CERAMIC C3225 JB 2E 104K-T	T
C401	4030011790	S.CERAMIC GRM55RF52A684ZD01L (GRM44-1)	T
C402	4030011790	S.CERAMIC GRM55RF52A684ZD01L (GRM44-1)	T
C403	4030011600	S.CERAMIC C1608 JB 1E 104K-T	T
C404	4030011600	S.CERAMIC C1608 JB 1E 104K-T	T
C405	4030006900	S.CERAMIC C1608 JB 1H 103K-T	T
C406	4030006900	S.CERAMIC C1608 JB 1H 103K-T	T
C407	4030017810	S.CERAMIC C1608 CH 1H 102J-T	T
C408	4030017810	S.CERAMIC C1608 CH 1H 102J-T	T
C409	4030018790	S.CERAMIC C3225 JB 2E 104K-T	T

M.-Mounted side (T: Mounted on the Top side, B: Mounted on the Bottom side)

[PA200W BOARD]

REF NO.	ORDER NO.	DESCRIPTION	M.
C410	4030018790	S.CERAMIC C3225 JB 2E 104K-T	T
C411	4030006880	S.CERAMIC C1608 JB 1H 472K-T	T
C412	4030006880	S.CERAMIC C1608 JB 1H 472K-T	T
C413	4030011600	S.CERAMIC C1608 JB 1E 104K-T	T
C414	4030011600	S.CERAMIC C1608 JB 1E 104K-T	T
C415	4030011790	S.CERAMIC GRM55RF52A684ZD01L (GRM44-1)	T
C416	4030011790	S.CERAMIC GRM55RF52A684ZD01L (GRM44-1)	T
C417	4030018760	S.CERAMIC C4532 CH 2A 104K-T	T
C418	4030018760	S.CERAMIC C4532 CH 2A 104K-T	T
C419	4030018760	S.CERAMIC C4532 CH 2A 104K-T	T
C420	4030018760	S.CERAMIC C4532 CH 2A 104K-T	T
C501	4030018790	S.CERAMIC C3225 JB 2E 104K-T	T
C502	4030018780	S.CERAMIC C3225 JB 2J 473K-T	T
C503	4030018770	S.CERAMIC C3216 CH 2J 102J-T	T
C504	4510006830	ELECTROLYTIC 63 MV 470CZ	T
C505	4510006830	ELECTROLYTIC 63 MV 470CZ	T
C506	4030006880	S.CERAMIC C1608 JB 1H 472K-T	T
C507	4030006880	S.CERAMIC C1608 JB 1H 472K-T	T
C510	4030018790	S.CERAMIC C3225 JB 2E 104K-T	T
C511	4030018780	S.CERAMIC C3225 JB 2J 473K-T	T
C512	4030018770	S.CERAMIC C3216 CH 2J 102J-T	T
C513	4510008050	ELECTROLYTIC 63 MV 220 CZ	T
C514	4030011790	S.CERAMIC GRM55RF52A684ZD01L (GRM44-1)	T
C515	4030011790	S.CERAMIC GRM55RF52A684ZD01L (GRM44-1)	T
J1	6510007020	CONNECTOR TMP-J01X-V6	T
J2	6510022310	S.CONNECTOR B5B-PH-SM3-TB	T
J5	6510020420	S.CONNECTOR S4B-PH-SM3-TB	T
J401	6510017920	CONNECTOR 1811P342	T
J402	6910001040	CONNECTOR IPS-1136	T
W401	9025900010	WIRE 23/05/085/B21/W07	T
W501	9040401001	JUMPER 74/98/050/X98/X98	T
EP1	0910057683	PCB B 5974C	T
EP501	6910011330	TERMINAL OT-009 M3	T
EP502	6910011330	TERMINAL OT-009 M3	T
EP503	6910000640	BEAD FSRH1090160RN000B (FSOH090RN)	T

[DC-DC BOARD]

REF NO.	ORDER NO.	DESCRIPTION	M.
IC21	1180002510	S.REG LM2673S-3.3	T
IC41	1180002510	S.REG LM2673S-3.3	T
IC61	1180002520	S.REG LM2673S-5.0	T
IC81	1180002520	S.REG LM2673S-5.0	T
IC101	1180002500	S.REG LM2673S-ADJ	T
IC121	1180002530	S.REG LM2594M-12	T
Q141	1590003310	S.TRANSISTOR DTD113ZK T146	T
D21	1750000960	S.DIODE RB081L-20	T
D41	1750000960	S.DIODE RB081L-20	T
D61	1750000960	S.DIODE RB081L-20	T
D81	1750000960	S.DIODE RB081L-20	T
D101	1750000960	S.DIODE RB081L-20	T
D121	1710000840	S.DIODE 1SR154-400 TE25	T
D122	1750001010	S.DIODE MBRD835LT4	T
D123	1750000960	S.DIODE RB081L-20	T
D141	1750000520	S.DIODE DAN222TL	T
L21	6200003950	S.COIL HF50ACC 322513-T	T
L22	6200010890	S.COIL CDRH124-150MC	T
L23	6200010880	S.COIL CDRH124-330MC	T
L41	6200009790	S.COIL BLM31PG121SN1	T
L42	6200010890	S.COIL CDRH124-150MC	T
L43	6200010880	S.COIL CDRH124-330MC	T
L44	6200009790	S.COIL BLM31PG121SN1	T
L61	6200003950	S.COIL HF50ACC 322513-T	T
L62	6200010900	S.COIL CDRH104R-100NC	T
L63	6200010880	S.COIL CDRH124-330MC	T
L81	6200003950	S.COIL HF50ACC 322513-T	T
L82	6200010900	S.COIL CDRH104R-100NC	T
L83	6200010880	S.COIL CDRH124-330MC	T
L101	6200003950	S.COIL HF50ACC 322513-T	T

S.-Surface mount

[DC-DC BOARD]

REF NO.	ORDER NO.	DESCRIPTION	M.
L102	6200010880	S.COIL CDRH124-330MC	T
L103	6190001190	S.COIL D10F-A814AY-101K=P3	T
L121	6190001640	S.COIL SLF12555T-101M1R1	T
L122	6190001190	S.COIL D10F-A814AY-101K=P3	T
L141	6200000970	S.COIL NL 322522T-100K	T
L142	6200010900	S.COIL CDRH104R-100NC	T
R21	7030006091	S.RESISTOR ERA3YED 822V	T
R41	7030006091	S.RESISTOR ERA3YED 822V	T
R61	7030006091	S.RESISTOR ERA3YED 822V	T
R81	7030006091	S.RESISTOR ERA3YED 822V	T
R101	7030009851	S.RESISTOR ERA3YED 271V	T
R102	7030007230	S.RESISTOR ERA3YED 102V	T
R103	7030006091	S.RESISTOR ERA3YED 822V	T
R121	7030003640	S.RESISTOR ERJ3GEYJ 473 V (47 kΩ)	T
R122	7030003640	S.RESISTOR ERJ3GEYJ 473 V (47 kΩ)	T
R141	7030008190	S.RESISTOR ERJ12YJ330U (33 Ω)	T
C9	4510007580	S.ELECTROLYTIC EEVFC1C101P	T
C21	4030011600	S.CERAMIC C1608 JB 1E 104K-T	T
C22	4510008230	S.ELECTROLYTIC EEFWA1A151P	T
C23	4030011340	S.CERAMIC C1608 CH 1H 471J-T	T
C24	4030004750	S.CERAMIC C2012 JB 1H 103K-T	T
C25	4030005110	S.CERAMIC C2012 JB 1E 473K-T	T
C26	4550006770	S.TANTALUM TEESVD2 1C 476M-12R	T
C27	4510008230	S.ELECTROLYTIC EEFWA1A151P	T
C41	4030011600	S.CERAMIC C1608 JB 1E 104K-T	T
C42	4510008230	S.ELECTROLYTIC EEFWA1A151P	T
C43	4030011340	S.CERAMIC C1608 CH 1H 471J-T	T
C44	4030004750	S.CERAMIC C2012 JB 1H 103K-T	T
C45	4030005110	S.CERAMIC C2012 JB 1E 473K-T	T
C46	4550007140	S.TANTALUM TEESVD 1C 107M12R	T
C47	4510008230	S.ELECTROLYTIC EEFWA1A151P	T
C61	4030011600	S.CERAMIC C1608 JB 1E 104K-T	T
C62	4510008230	S.ELECTROLYTIC EEFWA1A151P	T
C63	4030011340	S.CERAMIC C1608 CH 1H 471J-T	T
C64	4030004750	S.CERAMIC C2012 JB 1H 103K-T	T
C65	4030011600	S.CERAMIC C1608 JB 1E 104K-T	T
C66	4550006770	S.TANTALUM TEESVD2 1C 476M-12R	T
C67	4510008230	S.ELECTROLYTIC EEFWA1A151P	T
C81	4030011600	S.CERAMIC C1608 JB 1E 104K-T	T
C82	4510008230	S.ELECTROLYTIC EEFWA1A151P	T
C83	4030011340	S.CERAMIC C1608 CH 1H 471J-T	T
C84	4030004750	S.CERAMIC C2012 JB 1H 103K-T	T
C85	4030011600	S.CERAMIC C1608 JB 1E 104K-T	T
C86	4550006770	S.TANTALUM TEESVD2 1C 476M-12R	T
C87	4510008230	S.ELECTROLYTIC EEFWA1A151P	T
C101	4030011600	S.CERAMIC C1608 JB 1E 104K-T	T
C102	4510008230	S.ELECTROLYTIC EEFWA1A151P	T
C103	4030011340	S.CERAMIC C1608 CH 1H 471J-T	T
C104	4030004750	S.CERAMIC C2012 JB 1H 103K-T	T
C105	4030005110	S.CERAMIC C2012 JB 1E 473K-T	T
C106	4550006770	S.TANTALUM TEESVD2 1C 476M-12R	T
C107	4510008230	S.ELECTROLYTIC EEFWA1A151P	T
C122	4030011600	S.CERAMIC C1608 JB 1E 104K-T	T
C123	4510008170	S.ELECTROLYTIC EEVFC1V470P	T
C141	4030011600	S.CERAMIC C1608 JB 1E 104K-T	T
RL142	6330001760	RELAY AW3023	T
J2	6510003470	CONNECTOR B11B-EH-S	T
J3	6510003430	CONNECTOR B07B-EH-S	T
J4	6510003460	CONNECTOR B10B-EH-S	T
J5	6510020420	S.CONNECTOR S4B-PH-SM3-TB	T
W1	8900012780	CABLE OPC-1298	T
EP1	0910057713	PCB B 5975C	T

M.=Mounted side (T: Mounted on the Top side, B: Mounted on the Bottom side)

[TUNER UNIT]

REF NO.	ORDER NO.	DESCRIPTION	M.
P51	5610000350	CONNECTOR PHR-10	
P52	65100009610	CONNECTOR ZHR-5	
P53	65100009610	CONNECTOR ZHR-5	
MF1	2710000780	MOTOR MP24Z (STEPPING MOTOR	
MF2	2710000780	MOTOR MP24Z (STEPPING MOTOR	
MF3	2710000470	FAN MF80B-12H901	
W1	8900012900	CABLE OPC-1345	
W2	8900012900	CABLE OPC-1345	
W3	8900009410	CABLE OPC-927 (P=1 N=24 L=100)	
W51	9025900490	WIRE 23/00/230/B11/B09	
W52	9025900490	WIRE 23/00/230/B11/B09	
W53	9025900490	WIRE 23/00/230/B11/B09	
W54	9025900490	WIRE 23/00/230/B11/B09	
W55	9025900490	WIRE 23/00/230/B11/B09	
W56	9025900500	WIRE 23/08/230/B11/B09	
W57	9025900500	WIRE 23/08/230/B11/B09	
W58	9025900500	WIRE 23/08/230/B11/B09	
W59	9025900500	WIRE 23/08/230/B11/B09	
W60	9025900500	WIRE 23/08/230/B11/B09	

[CTRL BOARD]

REF NO.	ORDER NO.	DESCRIPTION	M.
IC1	1140004120	S.IC M38022M2-138FP	T
IC2	1130010390	S.IC HN58X2416T1	T
IC3	1130003920	S.IC TC4S69F (TE85R)	T
IC4	1180001070	S.IC TA7805F (TE16L)	B
IC5	1130009690	S.IC TC74HCT7007AF	B
IC6	1130006440	S.IC TC7S08F (TE85R)	T
IC51	1130011530	S.IC CD74HC4094M96	T
IC52	1130007690	S.IC BU4066BCF-E2	B
IC55	1130011530	S.IC CD74HC4094M96	B
IC56	1130011530	S.IC CD74HC4094M96	B
IC57	1160000130	S.IC TD62783AF (S,EL)	T
IC58	1160000130	S.IC TD62783AF (S,EL)	T
IC101	1110000960	S.IC NJM4558M-T1	T
IC151	1120002300	S.IC TC74AC04F	B
IC153	1130012010	S.IC TC7SZ32F (TE85L)	T
IC154	1130012010	S.IC TC7SZ32F (TE85L)	T
IC155	1130012010	S.IC TC7SZ32F (TE85L)	T
IC156	1130012020	S.IC TC74ACT112F (EL)	T
IC201	1110000960	S.IC NJM4558M-T1	T
IC301	1110002690	S.IC NJM2903M-T1	T
IC401	1160000130	S.IC TD62783AF (S,EL)	T
IC402	1160000130	S.IC TD62783AF (S,EL)	T
Q1	1590001330	S.TRANSISTOR DTA114EUA T106	T
Q2	1590000680	S.TRANSISTOR DTC114EUA T106	T
Q3	1590000680	S.TRANSISTOR DTC114EUA T106	T
Q4	1590000680	S.TRANSISTOR DTC114EUA T106	T
Q5	1590000680	S.TRANSISTOR DTC114EUA T106	T
Q6	1590000680	S.TRANSISTOR DTC114EUA T106	T
Q7	1590000680	S.TRANSISTOR DTC114EUA T106	T
Q8	1590000680	S.TRANSISTOR DTC114EUA T106	T
Q9	1590000680	S.TRANSISTOR DTC114EUA T106	T
Q10	1590000680	S.TRANSISTOR DTC114EUA T106	T
Q11	1590000680	S.TRANSISTOR DTC114EUA T106	B
Q51	1590000680	S.TRANSISTOR DTC114EUA T106	T
Q52	1590000680	S.TRANSISTOR DTC114EUA T106	T
Q53	1590000680	S.TRANSISTOR DTC114EUA T106	B
Q54	1560001260	S.FET 2SK3018 T106	B
Q55	1590000680	S.TRANSISTOR DTC114EUA T106	B
Q59	1590000680	S.TRANSISTOR DTC114EUA T106	T
Q201	1560000870	S.FET 2SK515-T1B (X33)	T
Q251	1590000680	S.TRANSISTOR DTC114EUA T106	T
D1	1730000410	S.ZENER RD5.1M-T2B2	T
D2	1710000780	S.DIODE MA114 (TX)	T
D3	1750000200	S.DIODE 1SS319 (TE85R)	B
D4	1750000200	S.DIODE 1SS319 (TE85R)	B
D5	1750000200	S.DIODE 1SS319 (TE85R)	B
D6	1750000200	S.DIODE 1SS319 (TE85R)	B
D7	1730000030	S.ZENER RD5.6M-T2B2	T
D101	1790000490	S.DIODE HSM88AS-TR	T
D102	1790000490	S.DIODE HSM88AS-TR	T

S.=Surface mount

[CTRL BOARD]

REF NO.	ORDER NO.	DESCRIPTION	M.
D103	1750000200	S.DIODE 1SS319 (TE85R)	T
D151	1790000490	S.DIODE HSM88AS-TR	T
D152	1790000490	S.DIODE HSM88AS-TR	T
D153	1790000490	S.DIODE HSM88AS-TR	T
D154	1790000490	S.DIODE HSM88AS-TR	T
D201	1790000490	S.DIODE HSM88AS-TR	T
D202	1790000490	S.DIODE HSM88AS-TR	T
D203	1750000200	S.DIODE 1SS319 (TE85R)	T
D251	1750000270	S.DIODE 1SS301 (TE85R)	T
D301	1790000490	S.DIODE HSM88AS-TR	T
D302	1790000490	S.DIODE HSM88AS-TR	T
X1	6050009890	S.XTAL CR-569 (6.144 MHz)	T
L1	6200003260	S.COIL NL 322522T-101J	T
L2	6200003260	S.COIL NL 322522T-101J	T
L4	2040000490	COIL EXC-ELDR25C	T
L5	6200005130	S.COIL NLC453232T-101K	T
L6	6200003590	S.COIL EXCCL3225U1	T
L7	6200003590	S.COIL EXCCL3225U1	T
L8	6200003590	S.COIL EXCCL3225U1	T
L9	6200003950	S.COIL HF50ACC 322513-T	B
L10	6200003950	S.COIL HF50ACC 322513-T	B
L51	6200003260	S.COIL NL 322522T-101J	T
L52	6200005130	S.COIL NLC453232T-101K	T
L101	6140004410	COIL LR-502	T
L102	6200001830	S.COIL NL 322522T-100J	T
L103	6200003260	S.COIL NL 322522T-101J	T
L151	6140004410	COIL LR-502	T
L152	6200001830	S.COIL NL 322522T-100J	T
L201	6140004410	COIL LR-502	T
L202	6180003300	COIL T6-222J (2.2M)	T
L301	6140004410	COIL LR-502	T
L302	6200003260	S.COIL NL 322522T-101J	B
L401	6200003950	S.COIL HF50ACC 322513-T	T
L402	6200003950	S.COIL HF50ACC 322513-T	T
R2	7030003680	S.RESISTOR ERJ3GEYJ 104 V (100 kΩ)	T
R3	7030003680	S.RESISTOR ERJ3GEYJ 104 V (100 kΩ)	T
R4	7030003680	S.RESISTOR ERJ3GEYJ 104 V (100 kΩ)	T
R5	7030003680	S.RESISTOR ERJ3GEYJ 104 V (100 kΩ)	T
R6	7030003560	S.RESISTOR ERJ3GEYJ 103 V (10 kΩ)	T
R7	7030003440	S.RESISTOR ERJ3GEYJ 102 V (1 kΩ)	T
R8	7030003680	S.RESISTOR ERJ3GEYJ 104 V (100 kΩ)	T
R9	7030003680	S.RESISTOR ERJ3GEYJ 104 V (100 kΩ)	T
R10	7030003680	S.RESISTOR ERJ3GEYJ 104 V (100 kΩ)	T
R11	7030003680	S.RESISTOR ERJ3GEYJ 104 V (100 kΩ)	T
R12	7030003440	S.RESISTOR ERJ3GEYJ 102 V (1 kΩ)	T
R13	7030003680	S.RESISTOR ERJ3GEYJ 104 V (100 kΩ)	T
R14	7030003680	S.RESISTOR ERJ3GEYJ 104 V (100 kΩ)	T
R15	7030003440	S.RESISTOR ERJ3GEYJ 102 V (1 kΩ)	T
R16	7030003320	S.RESISTOR ERJ3GEYJ 101 V (100 Ω)	T
R17	7030003560	S.RESISTOR ERJ3GEYJ 103 V (10 kΩ)	T
R18	7030003560	S.RESISTOR ERJ3GEYJ 103 V (10 kΩ)	T
R19	7030003680	S.RESISTOR ERJ3GEYJ 104 V (100 kΩ)	T
R20	7030003570	S.RESISTOR ERJ3GEYJ 123 V (12 kΩ)	T
R21	7030003650	S.RESISTOR ERJ3GEYJ 563 V (56 kΩ)	T
R22	7030003450	S.RESISTOR ERJ3GEYJ 122 V (1.2 kΩ)	T
R23	7030003560	S.RESISTOR ERJ3GEYJ 103 V (10 kΩ)	B
R24	7030003440	S.RESISTOR ERJ3GEYJ 102 V (1 kΩ)	B
R25	7030003380	S.RESISTOR ERJ3GEYJ 331 V (330 Ω)	B
R26	7030003380	S.RESISTOR ERJ3GEYJ 331 V (330 Ω)	B
R27	7030003380	S.RESISTOR ERJ3GEYJ 331 V (330 Ω)	B
R28	7030003380	S.RESISTOR ERJ3GEYJ 331 V (330 Ω)	B
R29	7030003380	S.RESISTOR ERJ3GEYJ 331 V (330 Ω)	B
R30	7030003380	S.RESISTOR ERJ3GEYJ 331 V (330 Ω)	B
R31	7030003380	S.RESISTOR ERJ3GEYJ 331 V (330 Ω)	B
R32	7030003380	S.RESISTOR ERJ3GEYJ 331 V (330 Ω)	B
R40	7030003440	S.RESISTOR ERJ3GEYJ 102 V (1 kΩ)	T
R42	7030003860	S.RESISTOR ERJ3GE JPW V	T
R43	7030003860	S.RESISTOR ERJ3GE JPW V	T
R44	7030003860	S.RESISTOR ERJ3GE JPW V	T
R45	7030003860	S.RESISTOR ERJ3GE JPW V	T
R46	7030003860	S.RESISTOR ERJ3GE JPW V	T
R51	7030003440	S.RESISTOR ERJ3GEYJ 102 V (1 kΩ)	B
R52	7030003440	S.RESISTOR ERJ3GEYJ 102 V (1 kΩ)	B
R53	7030003440	S.RESISTOR ERJ3GEYJ 102 V (1 kΩ)	B
R54	7030003440	S.RESISTOR ERJ3GEYJ 102 V (1 kΩ)	B
R55	7030003440	S.RESISTOR ERJ3GEYJ 102 V (1 kΩ)	B
R56	7030003440	S.RESISTOR ERJ3GEYJ 102 V (1 kΩ)	B
R57	7030003440	S.RESISTOR ERJ3GEYJ 102 V (1 kΩ)	B
R58	7030003440	S.RESISTOR ERJ3GEYJ 102 V (1 kΩ)	B
R59	7030003440	S.RESISTOR ERJ3GEYJ 102 V (1 kΩ)	B
R60	7030003440	S.RESISTOR ERJ3GEYJ 102 V (1 kΩ)	B
R61	7030003440	S.RESISTOR ERJ3GEYJ 102 V (1 kΩ)	T

M.=Mounted side (T: Mounted on the Top side, B: Mounted on the Bottom side)

[CTRL BOARD]

REF NO.	ORDER NO.	DESCRIPTION	M.
R62	7030003440	S.RESISTOR ERJ3GEYJ 102 V (1 kΩ)	T
R63	7030003440	S.RESISTOR ERJ3GEYJ 102 V (1 kΩ)	T
R64	7030003440	S.RESISTOR ERJ3GEYJ 102 V (1 kΩ)	T
R65	7030003440	S.RESISTOR ERJ3GEYJ 102 V (1 kΩ)	T
R66	7030003520	S.RESISTOR ERJ3GEYJ 472 V (4.7 kΩ)	B
R67	7030003200	S.RESISTOR ERJ3GEYJ 100 V (10 Ω)	T
R68	7030003200	S.RESISTOR ERJ3GEYJ 100 V (10 Ω)	T
R69	7030003200	S.RESISTOR ERJ3GEYJ 100 V (10 Ω)	T
R70	7030004040	S.RESISTOR ERJ3GEYJ 4R7 V (4.7 Ω)	T
R71	7030004040	S.RESISTOR ERJ3GEYJ 4R7 V (4.7 Ω)	T
R72	7030004040	S.RESISTOR ERJ3GEYJ 4R7 V (4.7 Ω)	T
R73	7030004040	S.RESISTOR ERJ3GEYJ 4R7 V (4.7 Ω)	T
R74	7030004040	S.RESISTOR ERJ3GEYJ 4R7 V (4.7 Ω)	T
R75	7030004040	S.RESISTOR ERJ3GEYJ 4R7 V (4.7 Ω)	T
R76	7030004040	S.RESISTOR ERJ3GEYJ 4R7 V (4.7 Ω)	T
R77	7030004040	S.RESISTOR ERJ3GEYJ 4R7 V (4.7 Ω)	T
R78	7030004040	S.RESISTOR ERJ3GEYJ 4R7 V (4.7 Ω)	B
R84	7030004040	S.RESISTOR ERJ3GEYJ 4R7 V (4.7 Ω)	B
R85	7030004040	S.RESISTOR ERJ3GEYJ 4R7 V (4.7 Ω)	B
R86	7030003560	S.RESISTOR ERJ3GEYJ 103 V (10 kΩ)	B
R87	7030003860	S.RESISTOR ERJ3GE JPW V	T
R88	7030003860	S.RESISTOR ERJ3GE JPW V	T
R89	7030003860	S.RESISTOR ERJ3GE JPW V	T
R90	7030003860	S.RESISTOR ERJ3GE JPW V	T
R91	7030003860	S.RESISTOR ERJ3GE JPW V	T
R92	7030003860	S.RESISTOR ERJ3GE JPW V	T
R95	7030003860	S.RESISTOR ERJ3GE JPW V	T
R97	7030003860	S.RESISTOR ERJ3GE JPW V	T
R101	7030010950	S.RESISTOR ERJ1TYJ 100U (10 Ω)	T
R102	7030010950	S.RESISTOR ERJ1TYJ 100U (10 Ω)	T
R103	7030003560	S.RESISTOR ERJ3GEYJ 103 V (10 kΩ)	T
R104	7030003560	S.RESISTOR ERJ3GEYJ 103 V (10 kΩ)	T
R105	7030003720	S.RESISTOR ERJ3GEYJ 224 V (220 kΩ)	T
R106	7030003720	S.RESISTOR ERJ3GEYJ 224 V (220 kΩ)	T
R107	7030003660	S.RESISTOR ERJ3GEYJ 683 V (68 kΩ)	T
R108	7030003660	S.RESISTOR ERJ3GEYJ 683 V (68 kΩ)	T
R109	7030003720	S.RESISTOR ERJ3GEYJ 224 V (220 kΩ)	T
R110	7030003720	S.RESISTOR ERJ3GEYJ 224 V (220 kΩ)	T
R111	7030003820	S.RESISTOR ERJ3GEYJ 155 V (1.5 MΩ)	T
R112	7030003810	S.RESISTOR ERJ3GEYJ 125 V (1.2 MΩ)	T
R113	7030003440	S.RESISTOR ERJ3GEYJ 102 V (1 kΩ)	T
R114	7030003440	S.RESISTOR ERJ3GEYJ 102 V (1 kΩ)	T
R151	7030007180	S.RESISTOR ERJ12YJ150U (15 Ω)	T
R152	7030007180	S.RESISTOR ERJ12YJ150U (15 Ω)	B
R153	7030007180	S.RESISTOR ERJ12YJ150U (15 Ω)	T
R154	7030007180	S.RESISTOR ERJ12YJ150U (15 Ω)	B
R155	7030003320	S.RESISTOR ERJ3GEYJ 101 V (100 Ω)	T
R157	7030003320	S.RESISTOR ERJ3GEYJ 101 V (100 Ω)	T
R158	7030003560	S.RESISTOR ERJ3GEYJ 103 V (10 kΩ)	T
R159	7030003560	S.RESISTOR ERJ3GEYJ 103 V (10 kΩ)	T
R160	7030003280	S.RESISTOR ERJ3GEYJ 470 V (47 Ω)	T
R161	7030003280	S.RESISTOR ERJ3GEYJ 470 V (47 Ω)	T
R162	7030003440	S.RESISTOR ERJ3GEYJ 102 V (1 kΩ)	T
R163	7030003440	S.RESISTOR ERJ3GEYJ 102 V (1 kΩ)	T
R164	7030003280	S.RESISTOR ERJ3GEYJ 470 V (47 Ω)	T
R165	7030003280	S.RESISTOR ERJ3GEYJ 470 V (47 Ω)	T
R166	7030003440	S.RESISTOR ERJ3GEYJ 102 V (1 kΩ)	T
R167	7030003440	S.RESISTOR ERJ3GEYJ 102 V (1 kΩ)	T
R168	7030003280	S.RESISTOR ERJ3GEYJ 470 V (47 Ω)	T
R169	7030003440	S.RESISTOR ERJ3GEYJ 102 V (1 kΩ)	T
R170	7030003280	S.RESISTOR ERJ3GEYJ 470 V (47 Ω)	T
R171	7030003280	S.RESISTOR ERJ3GEYJ 470 V (47 Ω)	T
R172	7030003480	S.RESISTOR ERJ3GEYJ 222 V (2.2 kΩ)	T
R173	7030003500	S.RESISTOR ERJ3GEYJ 332 V (3.3 kΩ)	T
R174	7030003360	S.RESISTOR ERJ3GEYJ 221 V (220 Ω)	T
R201	7030010550	S.RESISTOR ERJ1TYJ 820U (82 Ω)	T
R202	7030010550	S.RESISTOR ERJ1TYJ 820U (82 Ω)	B
R203	7030010550	S.RESISTOR ERJ1TYJ 820U (82 Ω)	T
R204	7030010550	S.RESISTOR ERJ1TYJ 820U (82 Ω)	B
R205	7030003560	S.RESISTOR ERJ3GEYJ 103 V (10 kΩ)	T
R206	7030003560	S.RESISTOR ERJ3GEYJ 103 V (10 kΩ)	T
R207	7030003800	S.RESISTOR ERJ3GEYJ 105 V (1 MΩ)	T
R208	7030003560	S.RESISTOR ERJ3GEYJ 103 V (10 kΩ)	T
R209	7030003520	S.RESISTOR ERJ3GEYJ 472 V (4.7 kΩ)	T
R210	7030003440	S.RESISTOR ERJ3GEYJ 102 V (1 kΩ)	T
R211	7030003480	S.RESISTOR ERJ3GEYJ 222 V (2.2 kΩ)	T
R212	7030003560	S.RESISTOR ERJ3GEYJ 103 V (10 kΩ)	T
R213	7030005331	S.RESISTOR ERA3YED 562V	T
R214	7030005331	S.RESISTOR ERA3YED 562V	T
R215	7030005871	S.RESISTOR ERA3YKD 104V (100 kΩ)	T
R216	7030008121	S.RESISTOR ERA3YED 682V	T
R217	7030008121	S.RESISTOR ERA3YED 682V	T
R218	7030005871	S.RESISTOR ERA3YKD 104V (100 kΩ)	T
R221	7030003670	S.RESISTOR ERJ3GEYJ 823 V (82 kΩ)	B
R222	7030003680	S.RESISTOR ERJ3GEYJ 104 V (100 kΩ)	T
R223	7030003820	S.RESISTOR ERJ3GEYJ 155 V (1.5 MΩ)	T
R224	7030003820	S.RESISTOR ERJ3GEYJ 155 V (1.5 MΩ)	T
R225	7030003560	S.RESISTOR ERJ3GEYJ 103 V (10 kΩ)	T

S.=Surface mount

[CTRL BOARD]

REF NO.	ORDER NO.	DESCRIPTION	M.
R226	7030003560	S.RESISTOR ERJ3GEYJ 103 V (10 kΩ)	T
R227	7030003560	S.RESISTOR ERJ3GEYJ 103 V (10 kΩ)	T
R228	7030003560	S.RESISTOR ERJ3GEYJ 103 V (10 kΩ)	T
R252	7030000230	S.RESISTOR MCR10EZJH 56 Ω (560)	T
R253	7030000230	S.RESISTOR MCR10EZJH 56 Ω (560)	T
R254	7030000230	S.RESISTOR MCR10EZJH 56 Ω (560)	T
R255	7030000220	S.RESISTOR MCR10EZJH 47 Ω (470)	T
R256	7030000230	S.RESISTOR MCR10EZJH 56 Ω (560)	T
R301	7030003560	S.RESISTOR ERJ3GEYJ 103 V (10 kΩ)	T
R302	7030003560	S.RESISTOR ERJ3GEYJ 103 V (10 kΩ)	T
R303	7030010910	S.RESISTOR ERJ1TYJ 150 Ω (15 Ω)	B
R304	7030003560	S.RESISTOR ERJ3GEYJ 103 V (10 kΩ)	T
R305	7030003720	S.RESISTOR ERJ3GEYJ 224 V (220 kΩ)	T
R306	7030003660	S.RESISTOR ERJ3GEYJ 683 V (68 kΩ)	T
R307	7030003660	S.RESISTOR ERJ3GEYJ 683 V (68 kΩ)	T
R308	7030003840	S.RESISTOR ERJ3GEYJ 225 V (2.2 MΩ)	B
R309	7030003720	S.RESISTOR ERJ3GEYJ 224 V (220 kΩ)	T
R310	7030003840	S.RESISTOR ERJ3GEYJ 225 V (2.2 MΩ)	T
R311	7030003440	S.RESISTOR ERJ3GEYJ 102 V (1 kΩ)	T
R312	7030003560	S.RESISTOR ERJ3GEYJ 103 V (10 kΩ)	T
R313	7030003700	S.RESISTOR ERJ3GEYJ 154 V (150 kΩ)	T
R401	7030004040	S.RESISTOR ERJ3GEYJ 4R7 V (4.7 Ω)	T
R402	7030004040	S.RESISTOR ERJ3GEYJ 4R7 V (4.7 Ω)	T
R403	7030004040	S.RESISTOR ERJ3GEYJ 4R7 V (4.7 Ω)	T
R404	7030004040	S.RESISTOR ERJ3GEYJ 4R7 V (4.7 Ω)	T
R405	7030004040	S.RESISTOR ERJ3GEYJ 4R7 V (4.7 Ω)	T
R406	7030004040	S.RESISTOR ERJ3GEYJ 4R7 V (4.7 Ω)	T
R407	7030004040	S.RESISTOR ERJ3GEYJ 4R7 V (4.7 Ω)	T
R408	7030004040	S.RESISTOR ERJ3GEYJ 4R7 V (4.7 Ω)	T
R409	7030004040	S.RESISTOR ERJ3GEYJ 4R7 V (4.7 Ω)	B
R410	7030004040	S.RESISTOR ERJ3GEYJ 4R7 V (4.7 Ω)	B
R411	7030004040	S.RESISTOR ERJ3GEYJ 4R7 V (4.7 Ω)	B
R412	7030004040	S.RESISTOR ERJ3GEYJ 4R7 V (4.7 Ω)	B
R413	7030004040	S.RESISTOR ERJ3GEYJ 4R7 V (4.7 Ω)	B
R414	7030004040	S.RESISTOR ERJ3GEYJ 4R7 V (4.7 Ω)	B
R415	7030004040	S.RESISTOR ERJ3GEYJ 4R7 V (4.7 Ω)	B
R416	7030004040	S.RESISTOR ERJ3GEYJ 4R7 V (4.7 Ω)	B
R417	7030003440	S.RESISTOR ERJ3GEYJ 102 V (1 kΩ)	B
R418	7030003440	S.RESISTOR ERJ3GEYJ 102 V (1 kΩ)	B
R419	7030003440	S.RESISTOR ERJ3GEYJ 102 V (1 kΩ)	B
R420	7030003440	S.RESISTOR ERJ3GEYJ 102 V (1 kΩ)	B
R421	7030003440	S.RESISTOR ERJ3GEYJ 102 V (1 kΩ)	B
R422	7030003440	S.RESISTOR ERJ3GEYJ 102 V (1 kΩ)	B
R423	7030003440	S.RESISTOR ERJ3GEYJ 102 V (1 kΩ)	B
R424	7030003440	S.RESISTOR ERJ3GEYJ 102 V (1 kΩ)	B
R425	7030003440	S.RESISTOR ERJ3GEYJ 102 V (1 kΩ)	B
R426	7030003440	S.RESISTOR ERJ3GEYJ 102 V (1 kΩ)	B
R427	7030003440	S.RESISTOR ERJ3GEYJ 102 V (1 kΩ)	B
R428	7030003440	S.RESISTOR ERJ3GEYJ 102 V (1 kΩ)	B
R429	7030003440	S.RESISTOR ERJ3GEYJ 102 V (1 kΩ)	B
R430	7030003440	S.RESISTOR ERJ3GEYJ 102 V (1 kΩ)	B
R431	7030003440	S.RESISTOR ERJ3GEYJ 102 V (1 kΩ)	B
R432	7030003440	S.RESISTOR ERJ3GEYJ 102 V (1 kΩ)	B
C1	4510004630	S.ELECTROLYTIC ECEV1CA100SR	T
C2	4030011600	S.CERAMIC C1608 JB 1E 104K-T	T
C3	4030006880	S.CERAMIC C1608 JB 1H 472K-T	T
C4	4030006900	S.CERAMIC C1608 JB 1H 103K-T	T
C5	4030006900	S.CERAMIC C1608 JB 1H 103K-T	T
C6	4030006880	S.CERAMIC C1608 JB 1H 472K-T	T
C7	4030017810	S.CERAMIC C1608 CH 1H 102J-T	T
C8	4030011600	S.CERAMIC C1608 JB 1E 104K-T	T
C9	4030009990	S.CERAMIC C1608 CH 1H 200J-T	T
C10	4030011600	S.CERAMIC C1608 JB 1E 104K-T	T
C11	4030006880	S.CERAMIC C1608 JB 1H 472K-T	T
C12	4030009990	S.CERAMIC C1608 CH 1H 200J-T	T
C13	4510006260	S.ELECTROLYTIC ECEV1AA471UP	T
C14	4030011600	S.CERAMIC C1608 JB 1E 104K-T	T
C15	4030011600	S.CERAMIC C1608 JB 1E 104K-T	T
C16	4510006220	S.ELECTROLYTIC ECEV1CA101UP	T
C17	4510004440	S.ELECTROLYTIC ECEV1HA010SR	T
C18	4510004440	S.ELECTROLYTIC ECEV1HA010SR	T
C19	4510004440	S.ELECTROLYTIC ECEV1HA010SR	T
C20	4510004440	S.ELECTROLYTIC ECEV1HA010SR	T
C21	4510004440	S.ELECTROLYTIC ECEV1HA010SR	T
C22	4510004440	S.ELECTROLYTIC ECEV1HA010SR	T
C23	4510004440	S.ELECTROLYTIC ECEV1HA010SR	T
C24	4510004440	S.ELECTROLYTIC ECEV1HA010SR	T
C25	4030011600	S.CERAMIC C1608 JB 1E 104K-T	T
C26	4030006880	S.CERAMIC C1608 JB 1H 472K-T	T
C38	4030011600	S.CERAMIC C1608 JB 1E 104K-T	T
C39	4510006260	S.ELECTROLYTIC ECEV1AA471UP	T
C40	4030011600	S.CERAMIC C1608 JB 1E 104K-T	T
C41	4030011600	S.CERAMIC C1608 JB 1E 104K-T	T
C43	4030006880	S.CERAMIC C1608 JB 1H 472K-T	T
C66	4510004630	S.ELECTROLYTIC ECEV1CA100SR	T
C68	4030011600	S.CERAMIC C1608 JB 1E 104K-T	B

[CTRL BOARD]

REF NO.	ORDER NO.	DESCRIPTION	M.
C69	4030011600	S.CERAMIC C1608 JB 1E 104K-T	T
C70	4030011600	S.CERAMIC C1608 JB 1E 104K-T	T
C71	4030011600	S.CERAMIC C1608 JB 1E 104K-T	T
C72	4510004630	S.ELECTROLYTIC ECEV1CA100SR	T
C88	4030011600	S.CERAMIC C1608 JB 1E 104K-T	B
C102	4010005530	CERAMIC HM60SJ SL 020C 500V	T
C103	4010005530	CERAMIC HM60SJ SL 020C 500V	T
C104	4610002250	TRIMMER TZ03R200Y169B00	T
C105	4030011540	S.CERAMIC C1608 CH 1H 750J-T	B
C106	4030011540	S.CERAMIC C1608 CH 1H 750J-T	T
C107	4030017810	S.CERAMIC C1608 CH 1H 102J-T	T
C108	4030017810	S.CERAMIC C1608 CH 1H 102J-T	T
C109	4030006880	S.CERAMIC C1608 JB 1H 472K-T	B
C110	4030006880	S.CERAMIC C1608 JB 1H 472K-T	B
C111	4510004630	S.ELECTROLYTIC ECEV1CA100SR	T
C112	4510004630	S.ELECTROLYTIC ECEV1CA100SR	T
C113	4030006880	S.CERAMIC C1608 JB 1H 472K-T	T
C114	4030006880	S.CERAMIC C1608 JB 1H 472K-T	T
C115	4030007100	S.CERAMIC C1608 CH 1H 560J-T	B
C116	4030011540	S.CERAMIC C1608 CH 1H 750J-T	T
C119	4030007100	S.CERAMIC C1608 CH 1H 560J-T	T
C151	4010005540	CERAMIC HM60SJ SL 030C 500V	T
C152	4030007070	S.CERAMIC C1608 CH 1H 330J-T	T
C153	4030007120	S.CERAMIC C1608 CH 1H 820J-T	T
C154	4030007070	S.CERAMIC C1608 CH 1H 330J-T	T
C155	4030007120	S.CERAMIC C1608 CH 1H 820J-T	T
C156	4030006880	S.CERAMIC C1608 JB 1H 472K-T	T
C157	4030006880	S.CERAMIC C1608 JB 1H 472K-T	T
C158	4030007060	S.CERAMIC C1608 CH 1H 270J-T	T
C159	4030006880	S.CERAMIC C1608 JB 1H 472K-T	T
C161	4030006880	S.CERAMIC C1608 JB 1H 472K-T	T
C162	4550003120	S.TANTALUM TEESVD2 1A 476M-12L	T
C163	4030007170	S.CERAMIC C1608 CH 1H 221J-T	T
C164	4030007170	S.CERAMIC C1608 CH 1H 221J-T	T
C165	4030006880	S.CERAMIC C1608 JB 1H 472K-T	T
C171	4030006880	S.CERAMIC C1608 JB 1H 472K-T	B
C173	4030006880	S.CERAMIC C1608 JB 1H 472K-T	T
C174	4030006880	S.CERAMIC C1608 JB 1H 472K-T	T
C175	4030006880	S.CERAMIC C1608 JB 1H 472K-T	T
C180	4030011600	S.CERAMIC C1608 JB 1E 104K-T	T
C181	4030011600	S.CERAMIC C1608 JB 1E 104K-T	T
C201	4010005580	CERAMIC HM60SJ SL 070D 500V	T
C202	4010005520	CERAMIC HM60SJ SL 010C 500V	T
C204	4030007130	S.CERAMIC C1608 CH 1H 101J-T	T
C205	4030011540	S.CERAMIC C1608 CH 1H 750J-T	T
C206	4030007110	S.CERAMIC C1608 CH 1H 680J-T	T
C207	4030006880	S.CERAMIC C1608 JB 1H 472K-T	T
C208	4030006880	S.CERAMIC C1608 JB 1H 472K-T	T
C209	4030017810	S.CERAMIC C1608 CH 1H 102J-T	T
C210	4030006880	S.CERAMIC C1608 JB 1H 472K-T	T
C211	4030006880	S.CERAMIC C1608 JB 1H 472K-T	T
C212	4030006880	S.CERAMIC C1608 JB 1H 472K-T	T
C213	4030006880	S.CERAMIC C1608 JB 1H 472K-T	B
C214	4030007170	S.CERAMIC C1608 CH 1H 221J-T	T
C215	4030007170	S.CERAMIC C1608 CH 1H 221J-T	T
C216	4030011340	S.CERAMIC C1608 CH 1H 471J-T	T
C217	4030011340	S.CERAMIC C1608 CH 1H 471J-T	T
C218	4030006880	S.CERAMIC C1608 JB 1H 472K-T	B
C252	4030006880	S.CERAMIC C1608 JB 1H 472K-T	T
C253	4030006880	S.CERAMIC C1608 JB 1H 472K-T	T
C254	4030006880	S.CERAMIC C1608 JB 1H 472K-T	T
C255	4030006880	S.CERAMIC C1608 JB 1H 472K-T	T
C301	4010005520	CERAMIC HM60SJ SL 010C 500V	T
C302	4030007030	S.CERAMIC C1608 CH 1H 150J-T	T
C303	4030007050	S.CERAMIC C1608 CH 1H 220J-T	T
C304	4030017810	S.CERAMIC C1608 CH 1H 102J-T	T
C305	4030017810	S.CERAMIC C1608 CH 1H 102J-T	T
C307	4030006880	S.CERAMIC C1608 JB 1H 472K-T	T
C308	4030006880	S.CERAMIC C1608 JB 1H 472K-T	T
C309	4030011600	S.CERAMIC C1608 JB 1E 104K-T	T
C310	4030009530	S.CERAMIC C1608 CH 1H 030B-T	T
C417	4510004630	S.ELECTROLYTIC ECEV1CA100SR	T
C418	4510004630	S.ELECTROLYTIC ECEV1CA100SR	T
C419	4030006880	S.CERAMIC C1608 JB 1H 472K-T	T
C420	4030006880	S.CERAMIC C1608 JB 1H 472K-T	T
RL251	6330001530	RELAY NR-HD (5V) AE5349	T
RL252	6330001460	RELAY FTR-F1CA012V	T
RL253	6330001460	RELAY FTR-F1CA012V	T
CP1	6910009670	S.CHECK P HK3-S-T	T
CP101	6910009670	S.CHECK P HK3-S-T	T
J1	6510023770	S.CONNECTOR 52793-2490	T
J2	6510023760	S.CONNECTOR S10B-PH-SM3-TB	T

M.=Mounted side (T: Mounted on the Top side, B: Mounted on the Bottom side)

S.=Surface mount

[CTRL BOARD]

REF NO.	ORDER NO.	DESCRIPTION	M.
J51	6510023770	S.CONNECTOR 52793-2490	T
J52	6510022030	S.CONNECTOR B10B-ZR-SM3-TF	T
J53	6510021430	S.CONNECTOR S8B-ZR-SM3A-TF	T
J101	6510017920	CONNECTOR 1811P342	T
J251	6510017920	CONNECTOR 1811P342	T
J252	6510017920	CONNECTOR 1811P342	T
J301	6510017920	CONNECTOR 1811P342	T
J351	6510007020	CONNECTOR TMP-J01X-V6	T
W1	9029804001	WIRE 72/99/040/X98/X98	
EP1	9040902903	TUBE IRRAX 0.7 (d) L=22 mm	
EP2	0910057663	PCB B 5976C	

[ANT-SW UNIT]

REF NO.	ORDER NO.	DESCRIPTION	M.
C73	4030006880	S.CERAMIC C1608 JB 1H 472K-T	T
C81	4030006880	S.CERAMIC C1608 JB 1H 472K-T	T
C82	4030006880	S.CERAMIC C1608 JB 1H 472K-T	T
C83	4030006880	S.CERAMIC C1608 JB 1H 472K-T	T
C84	4030006880	S.CERAMIC C1608 JB 1H 472K-T	T
RL51	6330001460	RELAY FTR-F1CA012V	T
RL52	6330001780	RELAY FTR-MYAA012D	T
RL53	6330001780	RELAY FTR-MYAA012D	T
RL61	6330001460	RELAY FTR-F1CA012V	T
RL62	6330001780	RELAY FTR-MYAA012D	T
RL63	6330001780	RELAY FTR-MYAA012D	T
RL71	6330001460	RELAY FTR-F1CA012V	T
RL72	6330001780	RELAY FTR-MYAA012D	T
RL73	6330001780	RELAY FTR-MYAA012D	T
RL81	6330001460	RELAY FTR-F1CA012V	T
RL82	6330001780	RELAY FTR-MYAA012D	T
RL83	6330001780	RELAY FTR-MYAA012D	T
RL84	6330001780	RELAY FTR-MYAA012D	T
J1	6510017930	CONNECTOR 1771P145-20	T
J2	6510007020	CONNECTOR TMP-J01X-V6	T
J3	6510007020	CONNECTOR TMP-J01X-V6	T
J4	6510019970	S.CONNECTOR 52808-1091	T
J51	6510000410	CONNECTOR MR-DS-E 02	B
J61	6510000410	CONNECTOR MR-DS-E 02	B
J71	6510000410	CONNECTOR MR-DS-E 02	B
J81	6510000410	CONNECTOR MR-DS-E 02	B
EP1	0910057672	PCB B 5978B	

[ANT-SW UNIT]

REF NO.	ORDER NO.	DESCRIPTION	M.
IC11	1130011510	S.IC BU2099FV-E2	T
IC12	1180002390	S.REG S-812C33AMC-C2N-T2	T
Q11	1590001000	S.TRANSISTOR RN2427 (TE85R)	T
Q12	1590001000	S.TRANSISTOR RN2427 (TE85R)	T
Q13	1590001000	S.TRANSISTOR RN2427 (TE85R)	T
Q14	1590001000	S.TRANSISTOR RN2427 (TE85R)	T
D51	1750000550	S.DIODE 1SS355 TE-17	T
D52	1750000550	S.DIODE 1SS355 TE-17	T
D53	1750000550	S.DIODE 1SS355 TE-17	T
D61	1750000550	S.DIODE 1SS355 TE-17	T
D62	1750000550	S.DIODE 1SS355 TE-17	T
D63	1750000550	S.DIODE 1SS355 TE-17	T
D71	1750000550	S.DIODE 1SS355 TE-17	T
D72	1750000550	S.DIODE 1SS355 TE-17	T
D73	1750000550	S.DIODE 1SS355 TE-17	T
D81	1750000550	S.DIODE 1SS355 TE-17	T
D82	1750000550	S.DIODE 1SS355 TE-17	T
D83	1750000550	S.DIODE 1SS355 TE-17	T
D84	1750000550	S.DIODE 1SS355 TE-17	T
L1	6200003590	S.COIL EXCCL3225U1	T
L2	6110001670	COIL LA-253	T
R1	7540000100	ABSORBER SRYH-350L	T
R2	7540000130	ABSORBER 2P-50A-301	T
R3	7540000130	ABSORBER 2P-50A-301	T
R11	7030003320	S.RESISTOR ERJ3GEYJ 101 V (100 Ω)	T
R12	7030003320	S.RESISTOR ERJ3GEYJ 101 V (100 Ω)	T
R13	7030003320	S.RESISTOR ERJ3GEYJ 101 V (100 Ω)	T
R14	7030003320	S.RESISTOR ERJ3GEYJ 101 V (100 Ω)	T
R15	7030003320	S.RESISTOR ERJ3GEYJ 101 V (100 Ω)	T
R16	7030003320	S.RESISTOR ERJ3GEYJ 101 V (100 Ω)	T
R17	7030003320	S.RESISTOR ERJ3GEYJ 101 V (100 Ω)	T
R18	7030003320	S.RESISTOR ERJ3GEYJ 101 V (100 Ω)	T
R19	7030003320	S.RESISTOR ERJ3GEYJ 101 V (100 Ω)	T
R20	7030003320	S.RESISTOR ERJ3GEYJ 101 V (100 Ω)	T
R21	7030003320	S.RESISTOR ERJ3GEYJ 101 V (100 Ω)	T
R22	7030003320	S.RESISTOR ERJ3GEYJ 101 V (100 Ω)	T
R23	7030003320	S.RESISTOR ERJ3GEYJ 101 V (100 Ω)	T
R24	7030003320	S.RESISTOR ERJ3GEYJ 101 V (100 Ω)	T
R25	7030003320	S.RESISTOR ERJ3GEYJ 101 V (100 Ω)	T
R26	7030003320	S.RESISTOR ERJ3GEYJ 101 V (100 Ω)	T
C1	4010005610	CERAMIC HM60SJ SL 100D 500V	T
C2	4010005660	CERAMIC HM60SJ SL 220J 500V	T
C11	4030011600	S.CERAMIC C1608 JB 1E 104K-T	T
C12	4030011600	S.CERAMIC C1608 JB 1E 104K-T	T
C51	4030006880	S.CERAMIC C1608 JB 1H 472K-T	T
C52	4030006880	S.CERAMIC C1608 JB 1H 472K-T	T
C53	4030006880	S.CERAMIC C1608 JB 1H 472K-T	T
C61	4030006880	S.CERAMIC C1608 JB 1H 472K-T	T
C62	4030006880	S.CERAMIC C1608 JB 1H 472K-T	T
C63	4030006880	S.CERAMIC C1608 JB 1H 472K-T	T
C71	4030006880	S.CERAMIC C1608 JB 1H 472K-T	T
C72	4030006880	S.CERAMIC C1608 JB 1H 472K-T	T

[OSC UNIT]

REF NO.	ORDER NO.	DESCRIPTION	M.
IC10	1180002610	S.REG BA12FP-E2	T
IC91	1190002000	S.IC AD5260BRU	T
IC92	1130005720	S.IC TC7W04F (TE12L)	T
Q10	1590000680	S.TRANSISTOR DTC114EUA T106	T
Q11	1590000680	S.TRANSISTOR DTC114EUA T106	T
Q12	1590000680	S.TRANSISTOR DTC114EUA T106	T
Q13	1590000680	S.TRANSISTOR DTC114EUA T106	T
Q21	1530002060	S.TRANSISTOR 2SC4081 T106 R	T
Q22	1530002600	S.TRANSISTOR 2SC4215-O (TE85R)	T
Q23	1590000680	S.TRANSISTOR DTC114EUA T106	T
Q42	1530002600	S.TRANSISTOR 2SC4215-O (TE85R)	T
Q43	1590000680	S.TRANSISTOR DTC114EUA T106	T
Q61	1530002060	S.TRANSISTOR 2SC4081 T106 R	T
Q62	1530002060	S.TRANSISTOR 2SC4081 T106 R	T
Q70	1530002060	S.TRANSISTOR 2SC4081 T106 R	T
Q101	1530002700	S.TRANSISTOR 2SC4097 T106Q	T
D10	1790001250	S.DIODE MA2S111-(TX)	T
D11	1790001250	S.DIODE MA2S111-(TX)	T
D71	1750000380	S.DIODE 1SS312 (TE85R)	T
D72	1750000380	S.DIODE 1SS312 (TE85R)	T
X1	6050011820	XTAL CR-772 OXCO	T
L1	6200003950	S.COIL HF50ACC 322513-T	T
L2	6200003950	S.COIL HF50ACC 322513-T	T
L10	6200003950	S.COIL HF50ACC 322513-T	T
L20	6200005490	S.COIL NL 322522T-331J	T
L21	6200003260	S.COIL NL 322522T-101J	T
L22	6200003260	S.COIL NL 322522T-101J	T
L23	6200003040	S.COIL NL 322522T-R68J-3	T
L24	6200003050	S.COIL NL 322522T-R82J-3	T
L41	6200003260	S.COIL NL 322522T-101J	T
L42	6200003260	S.COIL NL 322522T-101J	T
L43	6200003040	S.COIL NL 322522T-R68J-3	T
L44	6200003050	S.COIL NL 322522T-R82J-3	T
L61	6150004170	COIL LS-476	T
L62	6150004170	COIL LS-476	T
L91	6200003950	S.COIL HF50ACC 322513-T	T

M.-Mounted side (T: Mounted on the Top side, B: Mounted on the Bottom side)

S.-Surface mount

[OSC UNIT]

REF NO.	ORDER NO.	DESCRIPTION		M.
L92	6200003950	S.COIL	HF50ACC 322513-T	T
R1	7030003440	S.RESISTOR	ERJ3GEYJ 102 V (1 kΩ)	T
R2	7030003440	S.RESISTOR	ERJ3GEYJ 102 V (1 kΩ)	T
R3	7030003440	S.RESISTOR	ERJ3GEYJ 102 V (1 kΩ)	T
R11	7030003200	S.RESISTOR	ERJ3GEYJ 100 V (10 Ω)	T
R12	7030003200	S.RESISTOR	ERJ3GEYJ 100 V (10 Ω)	T
R13	7030003440	S.RESISTOR	ERJ3GEYJ 102 V (1 kΩ)	T
R20	7030003240	S.RESISTOR	ERJ3GEYJ 220 V (22 Ω)	T
R21	7030003560	S.RESISTOR	ERJ3GEYJ 103 V (10 kΩ)	T
R22	7030003370	S.RESISTOR	ERJ3GEYJ 271 V (270 Ω)	T
R23	7030004040	S.RESISTOR	ERJ3GEYJ 4R7 V (4.7 Ω)	T
R24	7030003370	S.RESISTOR	ERJ3GEYJ 271 V (270 Ω)	T
R25	7030003500	S.RESISTOR	ERJ3GEYJ 332 V (3.3 kΩ)	T
R26	7030003480	S.RESISTOR	ERJ3GEYJ 222 V (2.2 kΩ)	T
R27	7030003360	S.RESISTOR	ERJ3GEYJ 221 V (220 Ω)	T
R28	7030003440	S.RESISTOR	ERJ3GEYJ 102 V (1 kΩ)	T
R43	7030003240	S.RESISTOR	ERJ3GEYJ 220 V (22 Ω)	T
R44	7030003370	S.RESISTOR	ERJ3GEYJ 271 V (270 Ω)	T
R45	7030003500	S.RESISTOR	ERJ3GEYJ 332 V (3.3 kΩ)	T
R46	7030003480	S.RESISTOR	ERJ3GEYJ 222 V (2.2 kΩ)	T
R47	7030003290	S.RESISTOR	ERJ3GEYJ 560 V (56 Ω)	T
R61	7030003240	S.RESISTOR	ERJ3GEYJ 220 V (22 Ω)	T
R62	7030003560	S.RESISTOR	ERJ3GEYJ 103 V (10 kΩ)	T
R63	7030003380	S.RESISTOR	ERJ3GEYJ 331 V (330 Ω)	T
R64	7030003280	S.RESISTOR	ERJ3GEYJ 470 V (47 Ω)	T
R65	7030003400	S.RESISTOR	ERJ3GEYJ 471 V (470 Ω)	T
R67	7030003560	S.RESISTOR	ERJ3GEYJ 103 V (10 kΩ)	T
R68	7030003550	S.RESISTOR	ERJ3GEYJ 822 V (8.2 kΩ)	T
R71	7030003340	S.RESISTOR	ERJ3GEYJ 151 V (150 Ω)	T
R72	7030003270	S.RESISTOR	ERJ3GEYJ 390 V (39 Ω)	T
R73	7030003340	S.RESISTOR	ERJ3GEYJ 151 V (150 Ω)	T
R75	7030003280	S.RESISTOR	ERJ3GEYJ 470 V (47 Ω)	T
R77	7030003320	S.RESISTOR	ERJ3GEYJ 101 V (100 Ω)	T
R78	7030003470	S.RESISTOR	ERJ3GEYJ 182 V (1.8 kΩ)	T
R79	7030003480	S.RESISTOR	ERJ3GEYJ 222 V (2.2 kΩ)	T
R80	7030003360	S.RESISTOR	ERJ3GEYJ 221 V (220 Ω)	T
R82	7030003280	S.RESISTOR	ERJ3GEYJ 470 V (47 Ω)	T
R91	7030006091	S.RESISTOR	ERA3YED 822V	T
R92	7030005341	S.RESISTOR	ERA3YED 332V	T
R93	7030003560	S.RESISTOR	ERJ3GEYJ 103 V (10 kΩ)	T
R94	7030003540	S.RESISTOR	ERJ3GEYJ 682 V (6.8 kΩ)	T
R95	7030003320	S.RESISTOR	ERJ3GEYJ 101 V (100 Ω)	T
R96	7030003440	S.RESISTOR	ERJ3GEYJ 102 V (1 kΩ)	T
R97	7030003440	S.RESISTOR	ERJ3GEYJ 102 V (1 kΩ)	T
R98	7030003640	S.RESISTOR	ERJ3GEYJ 473 V (47 kΩ)	T
R99	7030003480	S.RESISTOR	ERJ3GEYJ 222 V (2.2 kΩ)	T
R100	7030003640	S.RESISTOR	ERJ3GEYJ 473 V (47 kΩ)	T
R101	7030003360	S.RESISTOR	ERJ3GEYJ 221 V (220 Ω)	T
R102	7030005981	S.RESISTOR	ERA3YED 333V	T
C1	4030006880	S.CERAMIC	C1608 JB 1H 472K-T	T
C2	4030006880	S.CERAMIC	C1608 JB 1H 472K-T	T
C3	4030006880	S.CERAMIC	C1608 JB 1H 472K-T	T
C4	4030006880	S.CERAMIC	C1608 JB 1H 472K-T	T
C5	4510004440	S.ELECTROLYTIC	ECEV1HA010SR	T
C6	4030006880	S.CERAMIC	C1608 JB 1H 472K-T	T
C7	4510004440	S.ELECTROLYTIC	ECEV1HA010SR	T
C8	4030011600	S.CERAMIC	C1608 JB 1E 104K-T	T
C9	4030006880	S.CERAMIC	C1608 JB 1H 472K-T	T
C10	4510005750	S.ELECTROLYTIC	ECEV1EA220SP	T
C11	4030004760	S.CERAMIC	C2012 JF 1H 104Z-T	T
C12	4030006880	S.CERAMIC	C1608 JB 1H 472K-T	T
C13	4510005750	S.ELECTROLYTIC	ECEV1EA220SP	T
C14	4030006880	S.CERAMIC	C1608 JB 1H 472K-T	T
C15	4030011600	S.CERAMIC	C1608 JB 1E 104K-T	T
C16	4030011600	S.CERAMIC	C1608 JB 1E 104K-T	T
C17	4030011600	S.CERAMIC	C1608 JB 1E 104K-T	T
C18	4030011600	S.CERAMIC	C1608 JB 1E 104K-T	T
C19	4030011600	S.CERAMIC	C1608 JB 1E 104K-T	T
C20	4030011600	S.CERAMIC	C1608 JB 1E 104K-T	T
C21	4030011600	S.CERAMIC	C1608 JB 1E 104K-T	T
C22	4030011600	S.CERAMIC	C1608 JB 1E 104K-T	T
C23	4030011600	S.CERAMIC	C1608 JB 1E 104K-T	T
C24	4030011600	S.CERAMIC	C1608 JB 1E 104K-T	T
C25	4030011600	S.CERAMIC	C1608 JB 1E 104K-T	T
C26	4030017800	S.CERAMIC	C1608 CH 1H 561J-T	T
C27	4030007120	S.CERAMIC	C1608 CH 1H 820J-T	T
C28	4030011340	S.CERAMIC	C1608 CH 1H 471J-T	T
C29	4030011330	S.CERAMIC	C1608 CH 1H 391J-T	T
C30	4030007050	S.CERAMIC	C1608 CH 1H 220J-T	T
C31	4030017800	S.CERAMIC	C1608 CH 1H 561J-T	T
C32	4030011600	S.CERAMIC	C1608 JB 1E 104K-T	T
C33	4030011600	S.CERAMIC	C1608 JB 1E 104K-T	T
C42	4030011600	S.CERAMIC	C1608 JB 1E 104K-T	T
C43	4030011600	S.CERAMIC	C1608 JB 1E 104K-T	T

M.=Mounted side (T: Mounted on the Top side, B: Mounted on the Bottom side)

[OSC UNIT]

REF NO.	ORDER NO.	DESCRIPTION		M.
C44	4030011600	S.CERAMIC	C1608 JB 1E 104K-T	T
C45	4030011600	S.CERAMIC	C1608 JB 1E 104K-T	T
C46	4030017800	S.CERAMIC	C1608 CH 1H 561J-T	T
C47	4030007120	S.CERAMIC	C1608 CH 1H 820J-T	T
C48	4030011340	S.CERAMIC	C1608 CH 1H 471J-T	T
C49	4030011330	S.CERAMIC	C1608 CH 1H 391J-T	T
C50	4030007050	S.CERAMIC	C1608 CH 1H 220J-T	T
C51	4030017800	S.CERAMIC	C1608 CH 1H 561J-T	T
C52	4030011600	S.CERAMIC	C1608 JB 1E 104K-T	T
C53	4030011600	S.CERAMIC	C1608 JB 1E 104K-T	T
C61	4030011600	S.CERAMIC	C1608 JB 1E 104K-T	T
C62	4030011600	S.CERAMIC	C1608 JB 1E 104K-T	T
C63	4030011600	S.CERAMIC	C1608 JB 1E 104K-T	T
C64	4030011600	S.CERAMIC	C1608 JB 1E 104K-T	T
C66	4030007010	S.CERAMIC	C1608 CH 1H 100D-T	T
C67	4030011600	S.CERAMIC	C1608 JB 1E 104K-T	T
C71	4030006880	S.CERAMIC	C1608 JB 1H 472K-T	T
C72	4030006880	S.CERAMIC	C1608 JB 1H 472K-T	T
C73	4030006880	S.CERAMIC	C1608 JB 1H 472K-T	T
C74	4030006880	S.CERAMIC	C1608 JB 1H 472K-T	T
C75	4030006880	S.CERAMIC	C1608 JB 1H 472K-T	T
C76	4030006880	S.CERAMIC	C1608 JB 1H 472K-T	T
C77	4030011600	S.CERAMIC	C1608 JB 1E 104K-T	T
C91	4030006880	S.CERAMIC	C1608 JB 1H 472K-T	T
C92	4030006880	S.CERAMIC	C1608 JB 1H 472K-T	T
C93	4030006880	S.CERAMIC	C1608 JB 1H 472K-T	T
C94	4030006880	S.CERAMIC	C1608 JB 1H 472K-T	T
C101	4550006480	S.TANTALUM	TEESVA 1C 475M8L	T
RL10	6330001750	RELAY	FTR-B4CA012Z	T
RL11	6330001750	RELAY	FTR-B4CA012Z	T
J2	6510019970	S.CONNECTOR	52808-1091	T
J71	6510007020	CONNECTOR	TMP-J01X-V6	T
J72	6510007020	CONNECTOR	TMP-J01X-V6	T
J73	6510007020	CONNECTOR	TMP-J01X-V6	T
EP1	0910057602	PCB	B 5979B	

[REG UNIT]

REF NO.	ORDER NO.	DESCRIPTION		M.
MF1	2710000520	FAN	SB0812H-ICOM-00	
EP1	6910016050	UNIT BOARD	FP2212B JPN [USA]	
	6910016060	UNIT BOARD	FP2212C JPN except [USA]	

S.=Surface mount

[DIGISEL UNIT]

REF NO.	ORDER NO.	DESCRIPTION	M.
IC1	1130011140	S.IC CAT24WC256K1.8	B
IC4	1130011510	S.IC BU2099FV-E2	T
IC5	1130011510	S.IC BU2099FV-E2	T
IC501	1130011140	S.IC CAT24WC256K1.8	B
IC504	1130011510	S.IC BU2099FV-E2	T
IC505	1130011510	S.IC BU2099FV-E2	T
Q201	1530003850	S.TRANSISTOR 2SC5551F-TD	T
Q701	1530003850	S.TRANSISTOR 2SC5551F-TD	T
D21	1750000550	S.DIODE 1SS355 TE-17	B
D51	1750000550	S.DIODE 1SS355 TE-17	B
D52	1750000550	S.DIODE 1SS355 TE-17	B
D53	1750000550	S.DIODE 1SS355 TE-17	T
D54	1750000550	S.DIODE 1SS355 TE-17	B
D55	1750000550	S.DIODE 1SS355 TE-17	B
D56	1750000550	S.DIODE 1SS355 TE-17	B
D57	1750000550	S.DIODE 1SS355 TE-17	T
D58	1750000550	S.DIODE 1SS355 TE-17	B
D59	1750000550	S.DIODE 1SS355 TE-17	B
D60	1750000550	S.DIODE 1SS355 TE-17	B
D61	1750000550	S.DIODE 1SS355 TE-17	B
D62	1750000550	S.DIODE 1SS355 TE-17	B
D63	1750000550	S.DIODE 1SS355 TE-17	B
D64	1750000550	S.DIODE 1SS355 TE-17	B
D65	1750000550	S.DIODE 1SS355 TE-17	B
D66	1750000550	S.DIODE 1SS355 TE-17	B
D67	1750000550	S.DIODE 1SS355 TE-17	B
D68	1750000550	S.DIODE 1SS355 TE-17	T
D69	1750000550	S.DIODE 1SS355 TE-17	B
D70	1750000550	S.DIODE 1SS355 TE-17	B
D71	1750000550	S.DIODE 1SS355 TE-17	B
D72	1750000550	S.DIODE 1SS355 TE-17	B
D73	1750000550	S.DIODE 1SS355 TE-17	B
D74	1750000550	S.DIODE 1SS355 TE-17	B
D75	1750000550	S.DIODE 1SS355 TE-17	B
D201	1710001020	DIODE XB15A204	T
D202	1710001020	DIODE XB15A204	T
D203	1750000550	S.DIODE 1SS355 TE-17	B
D204	1750000550	S.DIODE 1SS355 TE-17	B
D205	1750000550	S.DIODE 1SS355 TE-17	B
D521	1750000550	S.DIODE 1SS355 TE-17	B
D551	1750000550	S.DIODE 1SS355 TE-17	B
D552	1750000550	S.DIODE 1SS355 TE-17	B
D553	1750000550	S.DIODE 1SS355 TE-17	B
D554	1750000550	S.DIODE 1SS355 TE-17	B
D555	1750000550	S.DIODE 1SS355 TE-17	B
D556	1750000550	S.DIODE 1SS355 TE-17	B
D557	1750000550	S.DIODE 1SS355 TE-17	B
D558	1750000550	S.DIODE 1SS355 TE-17	B
D559	1750000550	S.DIODE 1SS355 TE-17	B
D560	1750000550	S.DIODE 1SS355 TE-17	B
D561	1750000550	S.DIODE 1SS355 TE-17	B
D562	1750000550	S.DIODE 1SS355 TE-17	B
D563	1750000550	S.DIODE 1SS355 TE-17	B
D564	1750000550	S.DIODE 1SS355 TE-17	B
D565	1750000550	S.DIODE 1SS355 TE-17	B
D566	1750000550	S.DIODE 1SS355 TE-17	B
D567	1750000550	S.DIODE 1SS355 TE-17	B
D568	1750000550	S.DIODE 1SS355 TE-17	B
D569	1750000550	S.DIODE 1SS355 TE-17	B
D570	1750000550	S.DIODE 1SS355 TE-17	B
D571	1750000550	S.DIODE 1SS355 TE-17	B
D572	1750000550	S.DIODE 1SS355 TE-17	B
D573	1750000550	S.DIODE 1SS355 TE-17	B
D574	1750000550	S.DIODE 1SS355 TE-17	B
D575	1750000550	S.DIODE 1SS355 TE-17	B
D701	1710001020	DIODE XB15A204	T
D702	1710001020	DIODE XB15A204	T
D703	1750000550	S.DIODE 1SS355 TE-17	B
D704	1750000550	S.DIODE 1SS355 TE-17	B
D705	1750000550	S.DIODE 1SS355 TE-17	T
L1	6200003260	S.COIL NL 322522T-101J	B
L2	6200003950	S.COIL HF50ACC 322513-T	B
L3	6200003260	S.COIL NL 322522T-101J	B
L4	6200003260	S.COIL NL 322522T-101J	B
L101	6140003980	COIL LR-476	T
L102	6140003990	COIL LR-477	T
L103	6140004001	COIL LR-478A	T
L104	6140004010	COIL LR-479	T
L105	6140004020	COIL LR-480	T
L106	6140004030	COIL LR-481	T
L107	6110003930	COIL LA-595	T
L201	6180000920	COIL LAL 03NA 221K	T

M.-Mounted side (T: Mounted on the Top side, B: Mounted on the Bottom side)

[DIGISEL UNIT]

REF NO.	ORDER NO.	DESCRIPTION	M.
L203	6140003940	COIL LR-493	T
L503	6200003260	S.COIL NL 322522T-101J	B
L504	6200003260	S.COIL NL 322522T-101J	B
L601	6140003980	COIL LR-476	T
L602	6140003990	COIL LR-477	T
L603	6140004001	COIL LR-478A	T
L604	6140004010	COIL LR-479	T
L605	6140004020	COIL LR-480	T
L606	6140004030	COIL LR-481	T
L607	6110003930	COIL LA-595	T
L701	6180000920	COIL LAL 03NA 221K	T
L703	6140003940	COIL LR-493	T
R1	7030003680	S.RESISTOR ERJ3GEYJ 104 V (100 kΩ)	B
R2	7030003560	S.RESISTOR ERJ3GEYJ 103 V (10 kΩ)	B
R3	7030003560	S.RESISTOR ERJ3GEYJ 103 V (10 kΩ)	T
R4	7030003440	S.RESISTOR ERJ3GEYJ 102 V (1 kΩ)	T
R5	7030003440	S.RESISTOR ERJ3GEYJ 102 V (1 kΩ)	T
R6	7030003440	S.RESISTOR ERJ3GEYJ 102 V (1 kΩ)	T
R7	7030003440	S.RESISTOR ERJ3GEYJ 102 V (1 kΩ)	T
R8	7030003440	S.RESISTOR ERJ3GEYJ 102 V (1 kΩ)	T
R9	7030003360	S.RESISTOR ERJ3GEYJ 221 V (220 Ω)	B
R10	7030003360	S.RESISTOR ERJ3GEYJ 221 V (220 Ω)	T
R35	7030003360	S.RESISTOR ERJ3GEYJ 221 V (220 Ω)	T
R36	7030003360	S.RESISTOR ERJ3GEYJ 221 V (220 Ω)	T
R37	7030003360	S.RESISTOR ERJ3GEYJ 221 V (220 Ω)	T
R38	7030003360	S.RESISTOR ERJ3GEYJ 221 V (220 Ω)	T
R39	7030003360	S.RESISTOR ERJ3GEYJ 221 V (220 Ω)	T
R40	7030003360	S.RESISTOR ERJ3GEYJ 221 V (220 Ω)	T
R41	7030003360	S.RESISTOR ERJ3GEYJ 221 V (220 Ω)	T
R42	7030003360	S.RESISTOR ERJ3GEYJ 221 V (220 Ω)	T
R43	7030003360	S.RESISTOR ERJ3GEYJ 221 V (220 Ω)	T
R44	7030003360	S.RESISTOR ERJ3GEYJ 221 V (220 Ω)	T
R45	7030003360	S.RESISTOR ERJ3GEYJ 221 V (220 Ω)	T
R46	7030003360	S.RESISTOR ERJ3GEYJ 221 V (220 Ω)	T
R47	7030003360	S.RESISTOR ERJ3GEYJ 221 V (220 Ω)	T
R48	7030003360	S.RESISTOR ERJ3GEYJ 221 V (220 Ω)	T
R49	7030003360	S.RESISTOR ERJ3GEYJ 221 V (220 Ω)	T
R50	7030003360	S.RESISTOR ERJ3GEYJ 221 V (220 Ω)	T
R51	7030003360	S.RESISTOR ERJ3GEYJ 221 V (220 Ω)	T
R52	7030003360	S.RESISTOR ERJ3GEYJ 221 V (220 Ω)	T
R53	7030003360	S.RESISTOR ERJ3GEYJ 221 V (220 Ω)	T
R54	7030003360	S.RESISTOR ERJ3GEYJ 221 V (220 Ω)	T
R55	7030003360	S.RESISTOR ERJ3GEYJ 221 V (220 Ω)	T
R56	7030003360	S.RESISTOR ERJ3GEYJ 221 V (220 Ω)	T
R57	7030003360	S.RESISTOR ERJ3GEYJ 221 V (220 Ω)	T
R58	7030003360	S.RESISTOR ERJ3GEYJ 221 V (220 Ω)	T
R59	7030003440	S.RESISTOR ERJ3GEYJ 102 V (1 kΩ)	T
R100	7030000010	S.RESISTOR MCR10EZJ JPW (000)	B
R104	7030003560	S.RESISTOR ERJ3GEYJ 103 V (10 kΩ)	B
R105	7030003560	S.RESISTOR ERJ3GEYJ 103 V (10 kΩ)	B
R201	7030000380	S.RESISTOR MCR10EZJ 1 kΩ	B
R202	7030000290	S.RESISTOR MCR10EZJ 180 Ω (181)	B
R203	7030000220	S.RESISTOR MCR10EZJ 47 Ω (470)	B
R204	7030003360	S.RESISTOR ERJ3GEYJ 221 V (220 Ω)	B
R205	7030003350	S.RESISTOR ERJ3GEYJ 181 V (180 Ω)	T
R206	7030003370	S.RESISTOR ERJ3GEYJ 271 V (270 Ω)	T
R207	7030003560	S.RESISTOR ERJ3GEYJ 103 V (10 kΩ)	B
R208	7030000200	S.RESISTOR MCR10EZJ 33 Ω (330)	B
R209	7030003240	S.RESISTOR ERJ3GEYJ 220 V (22 Ω)	T
R210	7030003370	S.RESISTOR ERJ3GEYJ 271 V (270 Ω)	B
R211	7030003370	S.RESISTOR ERJ3GEYJ 271 V (270 Ω)	B
R213	7030000220	S.RESISTOR MCR10EZJ 47 Ω (470)	B
R214	7030003460	S.RESISTOR ERJ3GEYJ 152 V (1.5 kΩ)	B
R215	7030003460	S.RESISTOR ERJ3GEYJ 152 V (1.5 kΩ)	B
R216	7030003680	S.RESISTOR ERJ3GEYJ 104 V (100 kΩ)	B
R501	7030003680	S.RESISTOR ERJ3GEYJ 104 V (100 kΩ)	B
H502	7030003560	S.RESISTOR ERJ3GEYJ 103 V (10 kΩ)	B
R503	7030003560	S.RESISTOR ERJ3GEYJ 103 V (10 kΩ)	B
R504	7030003440	S.RESISTOR ERJ3GEYJ 102 V (1 kΩ)	T
R505	7030003440	S.RESISTOR ERJ3GEYJ 102 V (1 kΩ)	T
R506	7030003440	S.RESISTOR ERJ3GEYJ 102 V (1 kΩ)	T
R507	7030003440	S.RESISTOR ERJ3GEYJ 102 V (1 kΩ)	B
R508	7030003440	S.RESISTOR ERJ3GEYJ 102 V (1 kΩ)	T
R509	7030003360	S.RESISTOR ERJ3GEYJ 221 V (220 Ω)	T
R510	7030003360	S.RESISTOR ERJ3GEYJ 221 V (220 Ω)	T
R535	7030003360	S.RESISTOR ERJ3GEYJ 221 V (220 Ω)	T
R536	7030003360	S.RESISTOR ERJ3GEYJ 221 V (220 Ω)	T
R537	7030003360	S.RESISTOR ERJ3GEYJ 221 V (220 Ω)	T
R538	7030003360	S.RESISTOR ERJ3GEYJ 221 V (220 Ω)	T
R539	7030003360	S.RESISTOR ERJ3GEYJ 221 V (220 Ω)	T
R540	7030003360	S.RESISTOR ERJ3GEYJ 221 V (220 Ω)	T
R541	7030003360	S.RESISTOR ERJ3GEYJ 221 V (220 Ω)	T
R542	7030003360	S.RESISTOR ERJ3GEYJ 221 V (220 Ω)	T
R543	7030003360	S.RESISTOR ERJ3GEYJ 221 V (220 Ω)	T
R544	7030003360	S.RESISTOR ERJ3GEYJ 221 V (220 Ω)	T
R545	7030003360	S.RESISTOR ERJ3GEYJ 221 V (220 Ω)	T

S.-Surface mount

[DIGISEL UNIT]

REF NO.	ORDER NO.	DESCRIPTION	M.
R546	7030003360	S.RESISTOR ERJ3GEYJ 221 V (220 Ω)	T
R547	7030003360	S.RESISTOR ERJ3GEYJ 221 V (220 Ω)	T
R548	7030003360	S.RESISTOR ERJ3GEYJ 221 V (220 Ω)	T
R549	7030003360	S.RESISTOR ERJ3GEYJ 221 V (220 Ω)	T
R550	7030003360	S.RESISTOR ERJ3GEYJ 221 V (220 Ω)	T
R551	7030003360	S.RESISTOR ERJ3GEYJ 221 V (220 Ω)	T
R552	7030003360	S.RESISTOR ERJ3GEYJ 221 V (220 Ω)	T
R553	7030003360	S.RESISTOR ERJ3GEYJ 221 V (220 Ω)	T
R554	7030003360	S.RESISTOR ERJ3GEYJ 221 V (220 Ω)	T
R555	7030003360	S.RESISTOR ERJ3GEYJ 221 V (220 Ω)	T
R556	7030003360	S.RESISTOR ERJ3GEYJ 221 V (220 Ω)	T
R557	7030003360	S.RESISTOR ERJ3GEYJ 221 V (220 Ω)	T
R558	7030003360	S.RESISTOR ERJ3GEYJ 221 V (220 Ω)	T
R600	7030000010	S.RESISTOR MCR10EZJH JPW (000)	B
R604	7030003560	S.RESISTOR ERJ3GEYJ 103 V (10 kΩ)	B
R605	7030003560	S.RESISTOR ERJ3GEYJ 103 V (10 kΩ)	B
R701	7030000380	S.RESISTOR MCR10EZJH 1 kΩ	T
R702	7030000290	S.RESISTOR MCR10EZJH 180 Ω (181)	T
R703	7030000220	S.RESISTOR MCR10EZJH 47 Ω (470)	T
R704	7030003360	S.RESISTOR ERJ3GEYJ 221 V (220 Ω)	T
R705	7030003350	S.RESISTOR ERJ3GEYJ 181 V (180 Ω)	T
R706	7030003370	S.RESISTOR ERJ3GEYJ 271 V (270 Ω)	B
R707	7030003560	S.RESISTOR ERJ3GEYJ 103 V (10 kΩ)	T
R708	7030000200	S.RESISTOR MCR10EZJH 33 Ω (330)	T
R709	7030003240	S.RESISTOR ERJ3GEYJ 220 V (22 Ω)	T
R710	7030003370	S.RESISTOR ERJ3GEYJ 271 V (270 Ω)	B
R711	7030003370	S.RESISTOR ERJ3GEYJ 271 V (270 Ω)	B
R713	7030000220	S.RESISTOR MCR10EZJH 47 Ω (470)	B
R714	7030003460	S.RESISTOR ERJ3GEYJ 152 V (1.5 kΩ)	T
R715	7030003460	S.RESISTOR ERJ3GEYJ 152 V (1.5 kΩ)	T
R716	7030003680	S.RESISTOR ERJ3GEYJ 104 V (100 kΩ)	B
C1	4030011600	S.CERAMIC C1608 JB 1E 104K-T	B
C2	4030011600	S.CERAMIC C1608 JB 1E 104K-T	T
C4	4030011600	S.CERAMIC C1608 JB 1E 104K-T	T
C5	4030011600	S.CERAMIC C1608 JB 1E 104K-T	T
C21	4030006880	S.CERAMIC C1608 JB 1H 472K-T	T
C35	4030006880	S.CERAMIC C1608 JB 1H 472K-T	B
C51	4030006880	S.CERAMIC C1608 JB 1H 472K-T	B
C52	4030006880	S.CERAMIC C1608 JB 1H 472K-T	T
C53	4030006880	S.CERAMIC C1608 JB 1H 472K-T	B
C54	4030006880	S.CERAMIC C1608 JB 1H 472K-T	T
C55	4030006880	S.CERAMIC C1608 JB 1H 472K-T	B
C56	4030006880	S.CERAMIC C1608 JB 1H 472K-T	T
C57	4030006880	S.CERAMIC C1608 JB 1H 472K-T	B
C58	4030006880	S.CERAMIC C1608 JB 1H 472K-T	T
C59	4030006880	S.CERAMIC C1608 JB 1H 472K-T	T
C60	4030006880	S.CERAMIC C1608 JB 1H 472K-T	T
C61	4030006880	S.CERAMIC C1608 JB 1H 472K-T	T
C62	4030006880	S.CERAMIC C1608 JB 1H 472K-T	T
C63	4030006880	S.CERAMIC C1608 JB 1H 472K-T	T
C64	4030006880	S.CERAMIC C1608 JB 1H 472K-T	T
C65	4030006880	S.CERAMIC C1608 JB 1H 472K-T	T
C66	4030006880	S.CERAMIC C1608 JB 1H 472K-T	B
C67	4030006880	S.CERAMIC C1608 JB 1H 472K-T	T
C68	4030006880	S.CERAMIC C1608 JB 1H 472K-T	T
C69	4030006880	S.CERAMIC C1608 JB 1H 472K-T	B
C70	4030006880	S.CERAMIC C1608 JB 1H 472K-T	T
C71	4030006880	S.CERAMIC C1608 JB 1H 472K-T	T
C72	4030006880	S.CERAMIC C1608 JB 1H 472K-T	T
C73	4030006880	S.CERAMIC C1608 JB 1H 472K-T	T
C74	4030006880	S.CERAMIC C1608 JB 1H 472K-T	T
C75	4030006880	S.CERAMIC C1608 JB 1H 472K-T	T
C101	4030011340	S.CERAMIC C1608 CH 1H 471J-T	T
C102	4030011280	S.CERAMIC C1608 CH 1H 271J-T	T
C103	4030011280	S.CERAMIC C1608 CH 1H 271J-T	T
C104	4030007130	S.CERAMIC C1608 CH 1H 101J-T	T
C105	4030006940	S.CERAMIC C1608 CH 1H 030C-T	T
C106	4030007150	S.CERAMIC C1608 CH 1H 151J-T	B
C107	4030007150	S.CERAMIC C1608 CH 1H 151J-T	B
C108	4030007150	S.CERAMIC C1608 CH 1H 151J-T	B
C109	4030007150	S.CERAMIC C1608 CH 1H 151J-T	B
C110	4030009520	S.CERAMIC C1608 CH 1H 020B-T	T
C111	4030009550	S.CERAMIC C1608 CH 1H 2R5B-T	T
C113	4030007000	S.CERAMIC C1608 CH 1H 090D-T	T
C114	4030007040	S.CERAMIC C1608 CH 1H 180J-T	T
C115	4030007040	S.CERAMIC C1608 CH 1H 180J-T	T
C116	4030007040	S.CERAMIC C1608 CH 1H 180J-T	T
C117	4030007070	S.CERAMIC C1608 CH 1H 330J-T	T
C118	4030007090	S.CERAMIC C1608 CH 1H 470J-T	B
C119	4030007040	S.CERAMIC C1608 CH 1H 180J-T	B
C120	4030007040	S.CERAMIC C1608 CH 1H 180J-T	B
C121	4030007040	S.CERAMIC C1608 CH 1H 180J-T	B
C122	4030007000	S.CERAMIC C1608 CH 1H 090D-T	B
C124	4030009520	S.CERAMIC C1608 CH 1H 020B-T	B
C125	4030009550	S.CERAMIC C1608 CH 1H 2R5B-T	B
C126	4030008360	S.CERAMIC C1608 UJ 1H 101J-T	B

M.=Mounted side (T: Mounted on the Top side, B: Mounted on the Bottom side)

[DIGISEL UNIT]

REF NO.	ORDER NO.	DESCRIPTION	M.
C128	4030009500	S.CERAMIC C1608 CH 1H 0R5B-T	B
C129	4030009510	S.CERAMIC C1608 CH 1H 010B-T	B
C130	4030009520	S.CERAMIC C1608 CH 1H 020B-T	B
C131	4030009910	S.CERAMIC C1608 CH 1H 040B-T	B
C132	4030006990	S.CERAMIC C1608 CH 1H 080D-T	B
C133	4030007040	S.CERAMIC C1608 CH 1H 180J-T	B
C134	4030008750	S.CERAMIC C1608 CH 1H 360J-T	B
C135	4030007110	S.CERAMIC C1608 CH 1H 680J-T	B
C136	4030007140	S.CERAMIC C1608 CH 1H 121J-T	B
C137	4030007140	S.CERAMIC C1608 CH 1H 121J-T	B
C138	4030007130	S.CERAMIC C1608 CH 1H 101J-T	B
C139	4030007160	S.CERAMIC C1608 CH 1H 181J-T	T
C140	4030007160	S.CERAMIC C1608 CH 1H 181J-T	B
C141	4030008330	S.CERAMIC C1608 UJ 1H 560J-T	B
C142	4030008330	S.CERAMIC C1608 UJ 1H 560J-T	B
C201	4030011600	S.CERAMIC C1608 JB 1E 104K-T	B
C202	4030006900	S.CERAMIC C1608 JB 1H 103K-T	T
C203	4030011600	S.CERAMIC C1608 JB 1E 104K-T	B
C204	4030011600	S.CERAMIC C1608 JB 1E 104K-T	B
C205	4030011600	S.CERAMIC C1608 JB 1E 104K-T	B
C206	4030011600	S.CERAMIC C1608 JB 1E 104K-T	B
C207	4030006880	S.CERAMIC C1608 JB 1H 472K-T	B
C208	4030007010	S.CERAMIC C1608 CH 1H 100D-T	T
C209	4030006880	S.CERAMIC C1608 JB 1H 472K-T	B
C210	4030006900	S.CERAMIC C1608 JB 1H 103K-T	B
C211	4030009000	S.CERAMIC C2012 JB 1C 224K-T	B
C212	4030006880	S.CERAMIC C1608 JB 1H 472K-T	B
C213	4030006880	S.CERAMIC C1608 JB 1H 472K-T	T
C214	4030006880	S.CERAMIC C1608 JB 1H 472K-T	B
C215	4030006880	S.CERAMIC C1608 JB 1H 472K-T	T
C501	4030011600	S.CERAMIC C1608 JB 1E 104K-T	B
C504	4030011600	S.CERAMIC C1608 JB 1E 104K-T	T
C505	4030011600	S.CERAMIC C1608 JB 1E 104K-T	T
C521	4030006880	S.CERAMIC C1608 JB 1H 472K-T	B
C535	4030006880	S.CERAMIC C1608 JB 1H 472K-T	T
C551	4030006880	S.CERAMIC C1608 JB 1H 472K-T	B
C552	4030006880	S.CERAMIC C1608 JB 1H 472K-T	T
C553	4030006880	S.CERAMIC C1608 JB 1H 472K-T	B
C554	4030006880	S.CERAMIC C1608 JB 1H 472K-T	T
C555	4030006880	S.CERAMIC C1608 JB 1H 472K-T	B
C556	4030006880	S.CERAMIC C1608 JB 1H 472K-T	B
C557	4030006880	S.CERAMIC C1608 JB 1H 472K-T	B
C558	4030006880	S.CERAMIC C1608 JB 1H 472K-T	T
C559	4030006880	S.CERAMIC C1608 JB 1H 472K-T	T
C560	4030006880	S.CERAMIC C1608 JB 1H 472K-T	T
C561	4030006880	S.CERAMIC C1608 JB 1H 472K-T	T
C562	4030006880	S.CERAMIC C1608 JB 1H 472K-T	T
C563	4030006880	S.CERAMIC C1608 JB 1H 472K-T	T
C564	4030006880	S.CERAMIC C1608 JB 1H 472K-T	T
C565	4030006880	S.CERAMIC C1608 JB 1H 472K-T	T
C566	4030006880	S.CERAMIC C1608 JB 1H 472K-T	B
C567	4030006880	S.CERAMIC C1608 JB 1H 472K-T	T
C568	4030006880	S.CERAMIC C1608 JB 1H 472K-T	T
C569	4030006880	S.CERAMIC C1608 JB 1H 472K-T	B
C570	4030006880	S.CERAMIC C1608 JB 1H 472K-T	T
C571	4030006880	S.CERAMIC C1608 JB 1H 472K-T	T
C572	4030006880	S.CERAMIC C1608 JB 1H 472K-T	T
C573	4030006880	S.CERAMIC C1608 JB 1H 472K-T	T
C574	4030006880	S.CERAMIC C1608 JB 1H 472K-T	T
C575	4030006880	S.CERAMIC C1608 JB 1H 472K-T	T
C601	4030011340	S.CERAMIC C1608 CH 1H 471J-T	B
C602	4030011280	S.CERAMIC C1608 CH 1H 271J-T	B
C603	4030011280	S.CERAMIC C1608 CH 1H 271J-T	T
C604	4030007130	S.CERAMIC C1608 CH 1H 101J-T	T
C605	4030006940	S.CERAMIC C1608 CH 1H 030C-T	T
C606	4030007150	S.CERAMIC C1608 CH 1H 151J-T	T
C607	4030007150	S.CERAMIC C1608 CH 1H 151J-T	T
C608	4030007150	S.CERAMIC C1608 CH 1H 151J-T	T
C609	4030007150	S.CERAMIC C1608 CH 1H 151J-T	T
C610	4030009520	S.CERAMIC C1608 CH 1H 020B-T	B
C611	4030009550	S.CERAMIC C1608 CH 1H 2R5B-T	B
C613	4030007000	S.CERAMIC C1608 CH 1H 090D-T	B
C614	4030007040	S.CERAMIC C1608 CH 1H 180J-T	B
C615	4030007040	S.CERAMIC C1608 CH 1H 180J-T	B
C616	4030007040	S.CERAMIC C1608 CH 1H 180J-T	B
C617	4030007070	S.CERAMIC C1608 CH 1H 330J-T	T
C618	4030007090	S.CERAMIC C1608 CH 1H 470J-T	T
C619	4030007040	S.CERAMIC C1608 CH 1H 180J-T	T
C620	4030007040	S.CERAMIC C1608 CH 1H 180J-T	T
C621	4030007040	S.CERAMIC C1608 CH 1H 180J-T	T
C622	4030007000	S.CERAMIC C1608 CH 1H 090D-T	T
C624	4030009520	S.CERAMIC C1608 CH 1H 020B-T	T
C625	4030009550	S.CERAMIC C1608 CH 1H 2R5B-T	T
C626	4030008360	S.CERAMIC C1608 UJ 1H 101J-T	B
C628	4030009500	S.CERAMIC C1608 CH 1H 0R5B-T	B
C629	4030009510	S.CERAMIC C1608 CH 1H 010B-T	B
C630	4030009520	S.CERAMIC C1608 CH 1H 020B-T	B
C631	4030009910	S.CERAMIC C1608 CH 1H 040B-T	B

S.=Surface mount

[DIGISEL UNIT]

REF NO.	ORDER NO.	DESCRIPTION		M.
C632	4030006990	S.CERAMIC	C1608 CH 1H 080D-T	B
C633	4030007040	S.CERAMIC	C1608 CH 1H 180J-T	B
C634	4030008750	S.CERAMIC	C1608 CH 1H 360J-T	B
C635	4030007110	S.CERAMIC	C1608 CH 1H 630J-T	B
C636	4030007140	S.CERAMIC	C1608 CH 1H 121J-T	B
C637	4030007140	S.CERAMIC	C1608 CH 1H 121J-T	B
C638	4030007130	S.CERAMIC	C1608 CH 1H 101J-T	B
C639	4030007160	S.CERAMIC	C1608 CH 1H 181J-T	B
C640	4030007160	S.CERAMIC	C1608 CH 1H 181J-T	B
C641	4030008330	S.CERAMIC	C1608 UJ 1H 560J-T	B
C642	4030008330	S.CERAMIC	C1608 UJ 1H 560J-T	B
C701	4030011600	S.CERAMIC	C1608 JB 1E 104K-T	T
C702	4030006900	S.CERAMIC	C1608 JB 1H 103K-T	T
C703	4030011600	S.CERAMIC	C1608 JB 1E 104K-T	B
C704	4030011600	S.CERAMIC	C1608 JB 1E 104K-T	B
C705	4030011600	S.CERAMIC	C1608 JB 1E 104K-T	B
C706	4030011600	S.CERAMIC	C1608 JB 1E 104K-T	T
C707	4030006880	S.CERAMIC	C1608 JB 1H 472K-T	B
C708	4030007010	S.CERAMIC	C1608 CH 1H 100D-T	B
C709	4030006880	S.CERAMIC	C1608 JB 1H 472K-T	B
C710	4030006900	S.CERAMIC	C1608 JB 1H 103K-T	B
C711	4030009000	S.CERAMIC	C2012 JB 1C 224K-T	B
C712	4030006880	S.CERAMIC	C1608 JB 1H 472K-T	T
C713	4030006880	S.CERAMIC	C1608 JB 1H 472K-T	B
C714	4030006880	S.CERAMIC	C1608 JB 1H 472K-T	B
C715	4030006880	S.CERAMIC	C1608 JB 1H 472K-T	T
RL2	6330001750	RELAY	FTR-B4CA012Z	T
RL21	6330001750	RELAY	FTR-B4CA012Z	T
RL51	6330001750	RELAY	FTR-B4CA012Z	T
RL52	6330001750	RELAY	FTR-B4CA012Z	T
RL53	6330001750	RELAY	FTR-B4CA012Z	T
RL54	6330001750	RELAY	FTR-B4CA012Z	T
RL55	6330001750	RELAY	FTR-B4CA012Z	T
RL56	6330001750	RELAY	FTR-B4CA012Z	T
RL57	6330001750	RELAY	FTR-B4CA012Z	T
RL58	6330001750	RELAY	FTR-B4CA012Z	T
RL59	6330001750	RELAY	FTR-B4CA012Z	T
RL60	6330001750	RELAY	FTR-B4CA012Z	T
RL61	6330001750	RELAY	FTR-B4CA012Z	T
RL62	6330001750	RELAY	FTR-B4CA012Z	T
RL63	6330001750	RELAY	FTR-B4CA012Z	T
RL64	6330001750	RELAY	FTR-B4CA012Z	T
RL65	6330001750	RELAY	FTR-B4CA012Z	T
RL66	6330001750	RELAY	FTR-B4CA012Z	T
RL67	6330001750	RELAY	FTR-B4CA012Z	T
RL69	6330001750	RELAY	FTR-B4CA012Z	T
RL70	6330001750	RELAY	FTR-B4CA012Z	T
RL71	6330001750	RELAY	FTR-B4CA012Z	T
RL72	6330001750	RELAY	FTR-B4CA012Z	T
RL73	6330001750	RELAY	FTR-B4CA012Z	T
RL74	6330001750	RELAY	FTR-B4CA012Z	T
RL75	6330001750	RELAY	FTR-B4CA012Z	T
RL76	6330001750	RELAY	FTR-B4CA012Z	T
RL201	6330001750	RELAY	FTR-B4CA012Z	T
RL502	6330001750	RELAY	FTR-B4CA012Z	T
RL521	6330001750	RELAY	FTR-B4CA012Z	T
RL551	6330001750	RELAY	FTR-B4CA012Z	T
RL552	6330001750	RELAY	FTR-B4CA012Z	T
RL553	6330001750	RELAY	FTR-B4CA012Z	T
RL554	6330001750	RELAY	FTR-B4CA012Z	T
RL555	6330001750	RELAY	FTR-B4CA012Z	T
RL556	6330001750	RELAY	FTR-B4CA012Z	T
RL557	6330001750	RELAY	FTR-B4CA012Z	T
RL558	6330001750	RELAY	FTR-B4CA012Z	T
RL559	6330001750	RELAY	FTR-B4CA012Z	T
RL560	6330001750	RELAY	FTR-B4CA012Z	T
RL561	6330001750	RELAY	FTR-B4CA012Z	T
RL562	6330001750	RELAY	FTR-B4CA012Z	T
RL563	6330001750	RELAY	FTR-B4CA012Z	T
RL564	6330001750	RELAY	FTR-B4CA012Z	T
RL565	6330001750	RELAY	FTR-B4CA012Z	T
RL566	6330001750	RELAY	FTR-B4CA012Z	T
RL567	6330001750	RELAY	FTR-B4CA012Z	T
RL569	6330001750	RELAY	FTR-B4CA012Z	T
RL570	6330001750	RELAY	FTR-B4CA012Z	T
RL571	6330001750	RELAY	FTR-B4CA012Z	T
RL572	6330001750	RELAY	FTR-B4CA012Z	T
RL573	6330001750	RELAY	FTR-B4CA012Z	T
RL574	6330001750	RELAY	FTR-B4CA012Z	T
RL575	6330001750	RELAY	FTR-B4CA012Z	T
RL576	6330001750	RELAY	FTR-B4CA012Z	T
RL701	6330001750	RELAY	FTR-B4CA012Z	T
J1	6510007020	CONNECTOR	TMP-J01X-V6	T
J2	6510007020	CONNECTOR	TMP-J01X-V6	T

M.-Mounted side (T: Mounted on the Top side, B: Mounted on the Bottom side)

[DIGISEL UNIT]

REF NO.	ORDER NO.	DESCRIPTION		M.
J10	6510020080	S.CONNECTOR	52808-2091	T
J501	6510007020	CONNECTOR	TMP-J01X-V6	T
J502	6510007020	CONNECTOR	TMP-J01X-V6	T
EP1	0910057403	PCB	B 5980C	

[NETWORK UNIT]

REF NO.	ORDER NO.	DESCRIPTION		M.
Q300	1520000560	S.TRANSISTOR	2SB1123T-TD	T
Q301	1590000680	S.TRANSISTOR	DTC114EUA T106	T
L50	6110003950	COIL	LA-598	T
L60	6110003910	COIL	LA-593	T
L70	6110003050	COIL	LA-492	T
L80	6110003050	COIL	LA-492	T
L90	6110003060	COIL	LA-493	T
L100	6110003070	COIL	LA-494	T
L110	6110003920	COIL	LA-594	T
L120	6140004320	COIL	LR-472	T
L130	6140004330	COIL	LR-473	T
L131	6140004330	COIL	LR-473	T
L300	6180000990	COIL	LAL 04NA 101K	T
R300	7030000420	S.RESISTOR	MCR10EZHZ 2.2 kΩ	T
R301	7030000420	S.RESISTOR	MCR10EZHZ 2.2 kΩ	T
R302	7030000420	S.RESISTOR	MCR10EZHZ 2.2 kΩ	T
R303	7030009800	S.RESISTOR	ERJ12YJ121U (120 Ω)	T
C1	4620000120	VARIABLE	UV44 150P	T
C2	4620000120	VARIABLE	UV44 150P	T
C3	4010007580	CERAMIC	HT20SJ SL 201J 3KV	T
C4	4010007580	CERAMIC	HT20SJ SL 201J 3KV	T
C5	4010007580	CERAMIC	HT20SJ SL 201J 3KV	T
C6	4010007580	CERAMIC	HT20SJ SL 201J 3KV	T
C7	4010007580	CERAMIC	HT20SJ SL 201J 3KV	T
C8	4010007580	CERAMIC	HT20SJ SL 201J 3KV	T
C9	4010007580	CERAMIC	HT20SJ SL 201J 3KV	T
C10	4010007580	CERAMIC	HT20SJ SL 201J 3KV	T
C20	4010007570	CERAMIC	HT15SJ SL 151J 3KV	T
C21	4010007570	CERAMIC	HT15SJ SL 151J 3KV	T
C22	4010007570	CERAMIC	HT15SJ SL 151J 3KV	T
C23	4010007570	CERAMIC	HT15SJ SL 151J 3KV	T
C24	4010007570	CERAMIC	HT15SJ SL 151J 3KV	T
C25	4010007570	CERAMIC	HT15SJ SL 151J 3KV	T
C26	4010007570	CERAMIC	HT15SJ SL 151J 3KV	T
C27	4010007570	CERAMIC	HT15SJ SL 151J 3KV	T
C30	4010007550	CERAMIC	HT11SJ SL 820J 3KV	T
C31	4010007550	CERAMIC	HT11SJ SL 820J 3KV	T
C32	4010007550	CERAMIC	HT11SJ SL 820J 3KV	T
C33	4010007550	CERAMIC	HT11SJ SL 820J 3KV	T
C34	4010007550	CERAMIC	HT11SJ SL 820J 3KV	T
C35	4010007550	CERAMIC	HT11SJ SL 820J 3KV	T
C36	4010007550	CERAMIC	HT11SJ SL 820J 3KV	T
C37	4010007550	CERAMIC	HT11SJ SL 820J 3KV	T
C40	4010008550	CERAMIC	DEA1X3F390JC3B (DE0607SL390J)	T
C41	4010008550	CERAMIC	DEA1X3F390JC3B (DE0607SL390J)	T
C42	4010008550	CERAMIC	DEA1X3F390JC3B (DE0607SL390J)	T
C43	4010008550	CERAMIC	DEA1X3F390JC3B (DE0607SL390J)	T
C44	4010008550	CERAMIC	DEA1X3F390JC3B (DE0607SL390J)	T
C45	4010008550	CERAMIC	DEA1X3F390JC3B (DE0607SL390J)	T
C46	4010008550	CERAMIC	DEA1X3F390JC3B (DE0607SL390J)	T
C47	4010008550	CERAMIC	DEA1X3F390JC3B (DE0607SL390J)	T
C50	4030006880	S.CERAMIC	C1608 JB 1H 472K-T	T
C60	4030006880	S.CERAMIC	C1608 JB 1H 472K-T	T
C70	4030006880	S.CERAMIC	C1608 JB 1H 472K-T	T
C80	4030006880	S.CERAMIC	C1608 JB 1H 472K-T	T
C90	4030006880	S.CERAMIC	C1608 JB 1H 472K-T	T
C100	4030006880	S.CERAMIC	C1608 JB 1H 472K-T	T
C110	4030006880	S.CERAMIC	C1608 JB 1H 472K-T	T
C120	4030006880	S.CERAMIC	C1608 JB 1H 472K-T	T
C202	4030006880	S.CERAMIC	C1608 JB 1H 472K-T	T
C203	4030006880	S.CERAMIC	C1608 JB 1H 472K-T	T
C204	4030006880	S.CERAMIC	C1608 JB 1H 472K-T	T
C205	4030006880	S.CERAMIC	C1608 JB 1H 472K-T	T
C206	4030006880	S.CERAMIC	C1608 JB 1H 472K-T	T
C207	4030006880	S.CERAMIC	C1608 JB 1H 472K-T	T

S.-Surface mount

[NETWORK UNIT]

REF NO.	ORDER NO.	DESCRIPTION		M.
C208	4030006880	S.CERAMIC	C1608 JB 1H 472K-T	T
C209	4030006880	S.CERAMIC	C1608 JB 1H 472K-T	T
C252	4030006880	S.CERAMIC	C1608 JB 1H 472K-T	T
C253	4030006880	S.CERAMIC	C1608 JB 1H 472K-T	T
C254	4030006880	S.CERAMIC	C1608 JB 1H 472K-T	T
C255	4030006880	S.CERAMIC	C1608 JB 1H 472K-T	T
C256	4030006880	S.CERAMIC	C1608 JB 1H 472K-T	T
C257	4030006880	S.CERAMIC	C1608 JB 1H 472K-T	T
C258	4030006880	S.CERAMIC	C1608 JB 1H 472K-T	T
C259	4030006880	S.CERAMIC	C1608 JB 1H 472K-T	T
C300	4030006880	S.CERAMIC	C1608 JB 1H 472K-T	T
C301	4030006880	S.CERAMIC	C1608 JB 1H 472K-T	T
RL10	6330001200	RELAY	VS-12MBU-UC	T
RL11	6330001200	RELAY	VS-12MBU-UC	T
RL20	6330001200	RELAY	VS-12MBU-UC	T
RL21	6330001200	RELAY	VS-12MBU-UC	T
RL30	6330001200	RELAY	VS-12MBU-UC	T
RL31	6330001200	RELAY	VS-12MBU-UC	T
RL40	6330001200	RELAY	VS-12MBU-UC	T
RL41	6330001200	RELAY	VS-12MBU-UC	T
RL50	6330001460	RELAY	FTR-F1CA012V	T
RL60	6330001200	RELAY	VS-12MBU-UC	T
RL70	6330001200	RELAY	VS-12MBU-UC	T
RL80	6330001200	RELAY	VS-12MBU-UC	T
RL90	6330001200	RELAY	VS-12MBU-UC	T
RL100	6330001200	RELAY	VS-12MBU-UC	T
RL110	6330001200	RELAY	VS-12MBU-UC	T
RL120	6330001200	RELAY	VS-12MBU-UC	T
J1	6510021560	S.CONNECTOR	52808-2490	T
J2	6510017930	CONNECTOR	1771P145-20	T
J3	6510017930	CONNECTOR	1771P145-20	T
J4	6510003520	CONNECTOR	S04B-EH-S	T
EP1	0910057692	PCB	B 5977B	

[FILTER UNIT]

REF NO.	ORDER NO.	DESCRIPTION		M.
L653	6140004170	COIL	LR-462	T
L654	6140004170	COIL	LR-462	T
L655	6200005130	S.COIL	NLC453232T-101K	T
L701	6200005130	S.COIL	NLC453232T-101K	T
L702	6140004130	COIL	LR-461	T
L703	6140004070	COIL	LR-460	T
L704	6140004070	COIL	LR-460	T
L705	6200005130	S.COIL	NLC453232T-101K	T
L751	6200005130	S.COIL	NLC453232T-101K	T
L752	6110003900	COIL	LA-592	T
L753	6110003890	COIL	LA-591	T
L754	6110003890	COIL	LA-591	T
L755	6200005130	S.COIL	NLC453232T-101K	T
L801	6200001830	S.COIL	NL 322522T-100J	T
L802	6110003880	COIL	LA-590	T
L803	6110003870	COIL	LA-589	T
L804	6110003870	COIL	LA-589	T
L805	6200001830	S.COIL	NL 322522T-100J	T
C401	4030006880	S.CERAMIC	C1608 JB 1H 472K-T	T
C402	4010008200	CERAMIC	HM11TJ SL 331J 500V	T
C403	4010008200	CERAMIC	HM11TJ SL 331J 500V	T
C404	4010008300	CERAMIC	HM11TJ SL 391J 500V	T
C405	4010008300	CERAMIC	HM11TJ SL 391J 500V	T
C406	4010008210	CERAMIC	HM60TJ SL 560J 500V	T
C407	4010007590	CERAMIC	HM15SJ SL 681J 500V	T
C408	4010007590	CERAMIC	HM15SJ SL 681J 500V	T
C409	4010007590	CERAMIC	HM15SJ SL 681J 500V	T
C410	4010005870	CERAMIC	HM95SJ SL 221J 500V	T
C411	4010008280	CERAMIC	HM95TJ SL 221J 500V	T
C412	4010008370	CERAMIC	HM60TJ SL 150J 500V	T
C413	4010007590	CERAMIC	HM15SJ SL 681J 500V	T
C414	4010007590	CERAMIC	HM15SJ SL 681J 500V	T
C415	4010007590	CERAMIC	HM15SJ SL 681J 500V	T
C416	4010008300	CERAMIC	HM11TJ SL 391J 500V	T
C417	4010008230	CERAMIC	HM60TJ SL 820J 500V	T
C418	4010007590	CERAMIC	HM15SJ SL 681J 500V	T
C419	4010007590	CERAMIC	HM15SJ SL 681J 500V	T
C420	4030006880	S.CERAMIC	C1608 JB 1H 472K-T	T
C451	4030006880	S.CERAMIC	C1608 JB 1H 472K-T	T
C452	4010008290	CERAMIC	HM95TJ SL 271J 500V	T
C453	4010008280	CERAMIC	HM95TJ SL 221J 500V	T
C454	4010008240	CERAMIC	HM60TJ SL 101J 500V	T
C455	4010005810	CERAMIC	HM74SJ SL 111J 500V	T
C456	4010007490	CERAMIC	HM15SJ SL 561J 500V	T
C457	4010006410	CERAMIC	HM13SJ SL 471J 500V	T
C458	4010008250	CERAMIC	HM74TJ SL 121J 500V	T
C459	4010005810	CERAMIC	HM74SJ SL 111J 500V	T
C461	4010007490	CERAMIC	HM15SJ SL 561J 500V	T
C462	4010007490	CERAMIC	HM15SJ SL 561J 500V	T
C463	4010008340	CERAMIC	HM60TJ SL 270J 500V	T
C464	4010008320	CERAMIC	HM60TJ SL 390J 500V	T
C465	4010007490	CERAMIC	HM15SJ SL 561J 500V	T
C466	4010008220	CERAMIC	HM60TJ SL 680J 500V	T
C467	4030006880	S.CERAMIC	C1608 JB 1H 472K-T	T
C468	4010008230	CERAMIC	HM60TJ SL 820J 500V	T
C501	4030006880	S.CERAMIC	C1608 JB 1H 472K-T	T
C502	4010008280	CERAMIC	HM95TJ SL 221J 500V	T
C503	4010008260	CERAMIC	HM74TJ SL 151J 500V	T
C504	4010008280	CERAMIC	HM95TJ SL 221J 500V	T
C506	4010008200	CERAMIC	HM11TJ SL 331J 500V	T
C507	4010008280	CERAMIC	HM95TJ SL 221J 500V	T
C508	4010008280	CERAMIC	HM95TJ SL 221J 500V	T
C509	4010005810	CERAMIC	HM74SJ SL 111J 500V	T
C511	4010008300	CERAMIC	HM11TJ SL 391J 500V	T
C512	4010008300	CERAMIC	HM11TJ SL 391J 500V	T
C513	4010008260	CERAMIC	HM74TJ SL 151J 500V	T
C514	4010008320	CERAMIC	HM60TJ SL 390J 500V	T
C515	4010008280	CERAMIC	HM95TJ SL 221J 500V	T
C516	4010008280	CERAMIC	HM95TJ SL 221J 500V	T
C517	4030006880	S.CERAMIC	C1608 JB 1H 472K-T	T
C518	4010008340	CERAMIC	HM60TJ SL 270J 500V	T
C551	4030006880	S.CERAMIC	C1608 JB 1H 472K-T	T
C552	4010005860	CERAMIC	HM95SJ SL 201J 500V	T
C554	4010008230	CERAMIC	HM60TJ SL 820J 500V	T
C555	4010008370	CERAMIC	HM60TJ SL 150J 500V	T
C556	4010008290	CERAMIC	HM95TJ SL 271J 500V	T
C557	4010008290	CERAMIC	HM95TJ SL 271J 500V	T
C558	4010008320	CERAMIC	HM60TJ SL 390J 500V	T
C559	4010008330	CERAMIC	HM60TJ SL 330J 500V	T
C560	4010008340	CERAMIC	HM60TJ SL 270J 500V	T
C561	4010008200	CERAMIC	HM11TJ SL 331J 500V	T
C562	4010008290	CERAMIC	HM95TJ SL 271J 500V	T
C563	4010008330	CERAMIC	HM60TJ SL 330J 500V	T
C564	4010005650	CERAMIC	HM60SJ SL 200J 500V	T
C565	4010008280	CERAMIC	HM95TJ SL 221J 500V	T
C566	4010008350	CERAMIC	HM60TJ SL 220J 500V	T

[FILTER UNIT]

REF NO.	ORDER NO.	DESCRIPTION		M.
D402	1750000270	S.DIODE	1SS301 (TE85R)	T
D452	1750000270	S.DIODE	1SS301 (TE85R)	T
D502	1750000270	S.DIODE	1SS301 (TE85R)	T
D552	1750000270	S.DIODE	1SS301 (TE85R)	T
D602	1750000270	S.DIODE	1SS301 (TE85R)	T
D652	1750000270	S.DIODE	1SS301 (TE85R)	T
D702	1750000270	S.DIODE	1SS301 (TE85R)	T
D752	1750000270	S.DIODE	1SS301 (TE85R)	T
D802	1750000270	S.DIODE	1SS301 (TE85R)	T
L401	6200005130	S.COIL	NLC453232T-101K	T
L402	6140004310	COIL	LR-471	T
L403	6140004300	COIL	LR-470	T
L404	6140004300	COIL	LR-470	T
L405	6200005130	S.COIL	NLC453232T-101K	T
L451	6200005130	S.COIL	NLC453232T-101K	T
L452	6140004270	COIL	LR-467	T
L453	6140004290	COIL	LR-469	T
L454	6140004290	COIL	LR-469	T
L455	6200005130	S.COIL	NLC453232T-101K	T
L501	6200005130	S.COIL	NLC453232T-101K	T
L502	6140004280	COIL	LR-468	T
L503	6140004270	COIL	LR-467	T
L504	6140004270	COIL	LR-467	T
L505	6200005130	S.COIL	NLC453232T-101K	T
L551	6200005130	S.COIL	NLC453232T-101K	T
L552	6140004260	COIL	LR-466	T
L553	6140004280	COIL	LR-468	T
L554	6140004280	COIL	LR-468	T
L555	6200005130	S.COIL	NLC453232T-101K	T
L601	6200005130	S.COIL	NLC453232T-101K	T
L602	6140004250	COIL	LR-465	T
L603	6140004240	COIL	LR-464	T
L604	6140004240	COIL	LR-464	T
L605	6200005130	S.COIL	NLC453232T-101K	T
L651	6200005130	S.COIL	NLC453232T-101K	T
L652	6140004200	COIL	LR-463	T

M.=Mounted side (T: Mounted on the Top side, B: Mounted on the Bottom side)

S.=Surface mount

[FILTER UNIT]

REF NO.	ORDER NO.	DESCRIPTION		M.
C567	4030006880	S.CERAMIC	C1608 JB 1H 472K-T	T
C601	4030006880	S.CERAMIC	C1608 JB 1H 472K-T	T
C604	4010008230	CERAMIC	HM60TJ SL 820J 500V	T
C605	4010008370	CERAMIC	HM60TJ SL 150J 500V	T
C606	4010008280	CERAMIC	HM95TJ SL 221J 500V	T
C607	4010008220	CERAMIC	HM60TJ SL 680J 500V	T
C608	4010008350	CERAMIC	HM60TJ SL 220J 500V	T
C609	4010008340	CERAMIC	HM60TJ SL 270J 500V	T
C610	4010008200	CERAMIC	HM11TJ SL 331J 500V	T
C611	4010008230	CERAMIC	HM60TJ SL 820J 500V	T
C612	4010008360	CERAMIC	HM60TJ SL 180J 500V	T
C613	4010008260	CERAMIC	HM74TJ SL 151J 500V	T
C614	4010008230	CERAMIC	HM60TJ SL 820J 500V	T
C615	4030006880	S.CERAMIC	C1608 JB 1H 472K-T	T
C651	4030006880	S.CERAMIC	C1608 JB 1H 472K-T	T
C654	4010008360	CERAMIC	HM60TJ SL 180J 500V	T
C655	4010008320	CERAMIC	HM60TJ SL 390J 500V	T
C656	4010008280	CERAMIC	HM95TJ SL 221J 500V	T
C657	4010008220	CERAMIC	HM60TJ SL 680J 500V	T
C658	4010008360	CERAMIC	HM60TJ SL 180J 500V	T
C659	4010008380	CERAMIC	HM60TJ SL 120J 500V	T
C660	4010008280	CERAMIC	HM95TJ SL 221J 500V	T
C661	4010008240	CERAMIC	HM60TJ SL 101J 500V	T
C662	4010008390	CERAMIC	HM60TJ SL 100D 500V	T
C663	4010008250	CERAMIC	HM74TJ SL 121J 500V	T
C664	4010008320	CERAMIC	HM60TJ SL 390J 500V	T
C665	4030006880	S.CERAMIC	C1608 JB 1H 472K-T	T
C701	4030006880	S.CERAMIC	C1608 JB 1H 472K-T	T
C703	4010008370	CERAMIC	HM60TJ SL 150J 500V	T
C704	4010008350	CERAMIC	HM60TJ SL 220J 500V	T
C705	4010005650	CERAMIC	HM60SJ SL 200J 500V	T
C706	4010005860	CERAMIC	HM95SJ SL 201J 500V	T
C707	4010008310	CERAMIC	HM60TJ SL 470J 500V	T
C708	4010008370	CERAMIC	HM60TJ SL 150J 500V	T
C709	4010008280	CERAMIC	HM95TJ SL 221J 500V	T
C710	4010008350	CERAMIC	HM60TJ SL 220J 500V	T
C712	4010008330	CERAMIC	HM60TJ SL 330J 500V	T
C713	4010008310	CERAMIC	HM60TJ SL 470J 500V	T
C714	4030006880	S.CERAMIC	C1608 JB 1H 472K-T	T
C715	4010008360	CERAMIC	HM60TJ SL 180J 500V	T
C751	4030006880	S.CERAMIC	C1608 JB 1H 472K-T	T
C755	4010008240	CERAMIC	HM60TJ SL 101J 500V	T
C756	4010008210	CERAMIC	HM60TJ SL 560J 500V	T
C757	4010008360	CERAMIC	HM60TJ SL 180J 500V	T
C758	4010008210	CERAMIC	HM60TJ SL 560J 500V	T
C759	4010008240	CERAMIC	HM60TJ SL 101J 500V	T
C760	4010008400	CERAMIC	HM60TJ SL 060D 500V	T
C761	4010008310	CERAMIC	HM60TJ SL 470J 500V	T
C763	4030006880	S.CERAMIC	C1608 JB 1H 472K-T	T
C764	4010005650	CERAMIC	HM60SJ SL 200J 500V	T
C765	4010008370	CERAMIC	HM60TJ SL 150J 500V	T
C801	4030006880	S.CERAMIC	C1608 JB 1H 472K-T	T
C804	4010008360	CERAMIC	HM60TJ SL 180J 500V	T
C805	4010008320	CERAMIC	HM60TJ SL 390J 500V	T
C806	4010008310	CERAMIC	HM60TJ SL 470J 500V	T
C807	4010005600	CERAMIC	HM60SJ SL 090D 500V	T
C808	4010008330	CERAMIC	HM60TJ SL 330J 500V	T
C809	4010008320	CERAMIC	HM60TJ SL 390J 500V	T
C810	4010008410	CERAMIC	HM60TJ SL 030C 500V	T
C811	4010005560	CERAMIC	HM60SJ SL 050C 500V	T
C813	4030006880	S.CERAMIC	C1608 JB 1H 472K-T	T
RL401	6330001470	RELAY	AJS1311	T
RL402	6330001470	RELAY	AJS1311	T
RL451	6330001470	RELAY	AJS1311	T
RL452	6330001470	RELAY	AJS1311	T
RL501	6330001470	RELAY	AJS1311	T
RL502	6330001470	RELAY	AJS1311	T
RL551	6330001470	RELAY	AJS1311	T
RL552	6330001470	RELAY	AJS1311	T
RL601	6330001470	RELAY	AJS1311	T
RL602	6330001470	RELAY	AJS1311	T
RL651	6330001470	RELAY	AJS1311	T
RL652	6330001470	RELAY	AJS1311	T
RL701	6330001470	RELAY	AJS1311	T
RL702	6330001470	RELAY	AJS1311	T
RL751	6330001470	RELAY	AJS1311	T
RL752	6330001470	RELAY	AJS1311	T
RL801	6330001460	RELAY	FTR-F1CA012V	T
RL802	6330001460	RELAY	FTR-F1CA012V	T
J901	6510017930	CONNECTOR	1771P145-20	T
J902	6510022030	S.CONNECTOR	B10B-ZR-SM3-TF	T
J903	6510019970	S.CONNECTOR	52808-1091	T
J904	6510017930	CONNECTOR	1771P145-20	T
J905	6510019420	S.CONNECTOR	B8B-ZR-SM3-TF	T

M.-Mounted side (T: Mounted on the Top side, B: Mounted on the Bottom side)

[FILTER UNIT]

REF NO.	ORDER NO.	DESCRIPTION		M.
EP1	0910057703	PCB	B 5958C	

[MEMORY BOARD]

REF NO.	ORDER NO.	DESCRIPTION		M.
IC1	1130012220	S.IC	E28F128J3C-150 (SX-2590A)	T
IC2	1130012230	S.IC	E28F128J3C-150	T
C1	4030011600	S.CERAMIC	C1608 JB 1E 104K-T	T
C2	4030011600	S.CERAMIC	C1608 JB 1E 104K-T	T
C3	4030011600	S.CERAMIC	C1608 JB 1E 104K-T	T
C4	4030011600	S.CERAMIC	C1608 JB 1E 104K-T	T
C5	4030011600	S.CERAMIC	C1608 JB 1E 104K-T	T
C6	4030011600	S.CERAMIC	C1608 JB 1E 104K-T	T
J1	6510024210	S.CONNECTOR	AXK6S30435P	T
J2	6510024200	S.CONNECTOR	AXK6S40435P	T
EP1	0910057392	PCB	B 5993B	

S.-Surface mount

SECTION 6 MECHANICAL PARTS AND DISSASSEMBLY

[CHASSIS PARTS]

REF. NO.	ORDER NO.	DESCRIPTION	QTY.
MF1	2710000760	Fan FD1240107B-1N	1
SP1	2510001260	2590 SP box	1
MP1	8930040720	1768 B-clip	1
MP2	8930061280	2590 ant angle	1
MP3	8930061840	2590 A-stand sheet	2
MP4	8510016031	2590 BPF case-1	1
MP5	8510016040	2590 BPF S-cover	1
MP6	8010019281	2590 Chassis-1	1
MP7	8930061720	2590 DIGISEL plate	1
MP8	8930062320	2590 A-DIGISEL sponge	1
MP10	8510015850	2590 FILTER case	1
MP11	8110008080	2590 L-cover	1
MP12	8110008091	2590 LOGIC cover-1	1
MP13	8930061350	2590 main stand	2
MP14	8930061960	2590 M-fan angle	1
MP15	8930061761	2590 M-jack angle-1	1
MP16	8510016100	2590 PLL plate	2
MP17	8510016010	2590 P-R cover	1
MP18	8210020460	2590 rear panel	1
MP20	8510015860	2590 SCOPE cover	1
MP21	8210019820	2590 side panel	2
MP22	8930062010	2590 S-jack angle	1
MP23	8930061950	2590 SP angle	1
MP27	8110008070	2590 U-cover	1
MP101	8810007230	Setscrew H M3 • 8	4
MP102	8810007230	Setscrew H M3 • 8	1
MP103	8810009110	Screw PH M2.6 • 16 ZK	2
MP104	8810005770	Screw BiH M3 • 8 ZK	2
MP105	8810005770	Screw BiH M3 • 8 ZK	2
MP106	8810008450	Screw BiH M4 • 8 ZK	4
MP107	8810005770	Screw BiH M3 • 8 ZK	8
MP108	8810008450	Screw BiH M4 • 8 ZK	14
MP109	8810008450	Screw BiH M4 • 8 ZK	13
MP110	8810008450	Screw BiH M4 • 8 ZK	4
MP111	8810008450	Screw BiH M4 • 8 ZK	2
MP112	8810008450	Screw BiH M4 • 8 ZK	2
MP113	8930011680	Rubber foot (G)	2
MP114	8810009650	Screw FH BT M3 • 8 NI-ZU	20
MP115	8810009650	Screw FH BT M3 • 8 NI-ZU	4
MP116	8810009460	Screw FH M3 • 8 ZK	4
MP117	8810009460	Screw FH M3 • 8 ZK	2
MP118	8810009460	Screw FH M3 • 8 ZK	1
MP119	8810009460	Screw FH M3 • 8 ZK	4
MP120	8810008630	Screw PH BT M3 • 6 NI-ZU	6
MP121	8810008660	Screw PH BT M3 • 8 NI-ZU	12
MP122	8810008660	Screw PH BT M3 • 8 NI-ZU	7
MP123	8810008660	Screw PH BT M3 • 8 NI-ZU	5
MP124	8810008660	Screw PH BT M3 • 8 NI-ZU	26
MP125	8810008660	Screw PH BT M3 • 8 NI-ZU	7
MP126	8810008660	Screw PH BT M3 • 8 NI-ZU	6
MP127	8810008660	Screw PH BT M3 • 8 NI-ZU	6
MP128	8810008660	Screw PH BT M3 • 8 NI-ZU	3
MP129	8810008660	Screw PH BT M3 • 8 NI-ZU	2
MP130	8810008660	Screw PH BT M3 • 8 NI-ZU	2
MP131	8810008660	Screw PH BT M3 • 8 NI-ZU	4
MP132	8810008660	Screw PH BT M3 • 8 NI-ZU	7
MP133	8810008660	Screw PH BT M3 • 8 NI-ZU	2
MP135	8810008660	Screw PH BT M3 • 8 NI-ZU	4
MP136	8810008660	Screw PH BT M3 • 8 NI-ZU	2
MP137	8810008660	Screw PH BT M3 • 8 NI-ZU	1
MP138	8810008660	Screw PH BT M3 • 8 NI-ZU	4
MP139	8810008660	Screw PH BT M3 • 8 NI-ZU	4
MP140	8810008660	Screw PH BT M3 • 8 NI-ZU	11
MP141	8810004430	Screw PH M3 • 6 ZK	2
MP142	8810004430	Screw PH M3 • 6 ZK	4

[CHASSIS PARTS]

REF. NO.	ORDER NO.	DESCRIPTION	QTY.
MP143	8810009990	Screw PH BT M3 • 8 ZK	1
MP144	8810004430	Screw PH M3 • 6 ZK	4
MP145	8810008690	Screw PH BT M4 • 16 NI-ZU	2
MP146	8830000360	Wing nut M5 NI	1
MP147	8930028390	Himelon sheet AH	1
MP148	8850000150	Flat washer M5 NI BS	2
MP150	8930049850	2240 D-sponge 3.5 • 5 • 50	1
MP151	8930049850	2240 D-sponge 3.5 • 5 • 50	1
MP152	8930017190	Earth spring (F)	1
MP153	8930017190	Earth spring (F)	1
MP154	8510016281	2590 K-plate-1	1
MP155	8930056160	Double side tape (AG)	4
MP156	8810004430	Screw PH M3 • 6 ZK	1
MP157	8930062690	Sponge (HQ)	1
MP158	8930062720	Sponge (HS)	1
MP159	8930062270	2590 A-net	1
MP160	8930062280	2590 B-net	1
MP161	8930062290	2590 C-net	1
MP162	8930062360	2590 D-net	1
MP163	8930006960	Sponge (Y)	1
MP164	8930062770	Himelon sheet (CN)	1
MP165	8930058170	Shield sponge (O)	1
MP166	8930058170	Shield sponge (O)	1
MP167	8930017190	Earth spring (F)	1
MP169	8930063220	AL sheet (AJ)	1

[FRONT PARTS]

REF. NO.	ORDER NO.	DESCRIPTION	QTY.
EP1	6910015290	LCD unit EDTCB23QAF	1
EP11	6910011090	Main sensor RMS20-250-201-P	1
EP12	6910011090	Sub sensor RMS20-250-201-P	1
EP13	0880001460	Rit sensor	1
EP101	6910015650	Mount plate S-G2218-3#01	1
EP102	6910015650	Mount plate S-G2218-3#01	1
MP1	8810008970	Screw FH BT M2 • 3.5 NI-ZU	2
MP2	8810009180	Screw FH BT M2 • 5 NI-ZU	3
MP3	8810009180	Screw FH BT M2 • 5 NI-ZU	1
MP4	8810009180	Screw FH BT M2 • 5 NI-ZU	2
MP5	8810005700	Screw PH M2 • 4 ZK	2
MP7	8210019931	2590 10-key panel-1	1
MP10	8930061450	2590 brake button	1
MP11	8930061470	2590 brake plate	1
MP12	8930061460	2590 brake spacer	1
MP13	8930060640	2590 CF lens	1
MP14	8110008100	2590 CF lens cover	1
MP15	8930060651	2590 CF plate -1	1
MP17	8930060581	2590 EJECT button-1	1
MP19	8210019800	2590 front panel	1
MP20	8930060600	2590 JACK plate	1
MP21	8930060591	2590 LCD holder-1	1
MP22	8930061620	2590 LCD sponge	1
MP23	8930062561	2590 LENS holder-1 assembly	1
MP24	8310059640	2590 name plate	1
MP25	8930060690	2590 spring	1
MP26	8010019311	2590 sub chassis-1	1
MP27	8930060622	2590 VR plate-2	1
MP28	8310061241	2590 window frame-1 assembly	1
MP29	8310059661	2590 window plate-1	1

Screw abbreviations BT: Self-tapping PH: Pan head
 FH: Flat head BiH: Binding head
 ZK: Black BS: Brass
 NI: Nickel SUS: Stainless
 NI-ZU: Nickel-Zinc

[FRONT PARTS]

REF. NO.	ORDER NO.	DESCRIPTION	QTY.
MP30	8930062190	Double side tape (AJ)	2
MP31	8930062180	Double side tape (AK)	2
MP32	8930062170	Double side tape (AL)	3
MP33	8610012051	Knob K230-1 assembly	1
MP34	8610012061	Knob K231-1 assembly	1
MP35	8610012071	Knob K232-1 assembly	2
MP36	8610011391	Knob K233-1	1
MP37	8610011451	Knob K234-1	1
MP38	8610011461	Knob K234 (A)-1	1
MP39	8610011471	Knob K234 (B)-1	1
MP40	8610011481	Knob K235-1	1
MP41	8610011491	Knob K236-1	1
MP42	8610011501	Knob K237-1	1
MP43	8610011511	Knob K237 (A)-1	1
MP44	8610011521	Knob K238-1	1
MP45	8610011531	Knob K239-1	1
MP46	8610011541	Knob K239 (A)-1	1
MP47	8610011551	Knob K240-1	1
MP48	8610012081	Knob K241-1 assembly	1
MP49	8610011561	Knob K243-1	1
MP50	8610011421	Knob K244-1	1
MP51	8610011431	Knob K245-1	1
MP52	8610011950	Knob N300 assembly (green)	3
MP53	8610011960	Knob N300 (A) assembly (red)	3
MP55	8610011830	Knob N301	2
MP56	8610011970	Knob N302 assembly	2
MP58	8610011760	Knob N303 (green)	1
MP59	8610011770	Knob N303(A) (red)	1
MP60	8610011780	Knob N303(B) (gray)	2
MP61	8610011980	Knob N304 assembly (green)	1
MP62	8610011990	Knob N304 (A) assembly (red)	1
MP63	8610012000	Knob N304 (B) assembly (gray)	2
MP65	8610012010	Knob N305 assembly	1
MP67	8610012020	Knob N306 assembly	1
MP68	8610011840	Knob N-306 cover	1
MP70	8610011740	Knob N307	7
MP71	8610012030	Knob N309 assembly	1
MP72	8610011850	Knob N-309 cover	1
MP75	8610011810	Knob N310 (green)	3
MP76	8610011820	Knob N310 (A) (red)	3
MP77	8610012040	Knob N311 assembly	1
MP78	8850002010	Plain washer (AG)	1
MP79	8930062080	Rubber tube (C)	12
MP80	8930062090	Rubber tube (D)	2
MP81	8930061731	Sponge (HI)-1	2
MP82	8810008450	Screw BiH M4 • 8 ZK	4
MP84	8810008760	Screw PH BT M2 • 8 NI-ZU	10
MP85	8810008760	Screw PH BT M2 • 8 NI-ZU	4
MP86	8810008760	Screw PH BT M2 • 8 NI-ZU	4
MP87	8810008760	Screw PH BT M2 • 8 NI-ZU	2
MP88	8810008760	Screw PH BT M2 • 8 NI-ZU	10
MP90	8810008630	Screw PH BT M3 • 6 NI-ZU	4
MP91	8810008630	Screw PH BT M3 • 6 NI-ZU	4
MP92	8810008630	Screw PH BT M3 • 6 NI-ZU	4
MP93	8810008630	Screw PH BT M3 • 6 NI-ZU	1
MP94	8810008630	Screw PH BT M3 • 6 NI-ZU	2
MP95	8810008630	Screw PH BT M3 • 6 NI-ZU	3
MP99	8810009180	Screw FH BT M2 • 5 NI-ZU	2
MP100	8930062350	Double side tape (AM)	1
MP102	8930062380	Insulation sheet (HR)	1
MP103	8930006960	Sponge (Y)	1
MP104	8930019010	Sponge (CI)	1
MP105	8930062910	Double side tape (AO)	2
MP106	8930062170	Double side tape (AL)	2

Screw abbreviations BT: Self-tapping PH: Pan head
 FH: Flat head BiH: Binding head
 ZK: Black BS: Brass
 NI: Nickel SUS: Stainless
 NI-ZU: Nickel-Zinc

[DISPLAY BOARD]

REF. NO.	ORDER NO.	DESCRIPTION	QTY.
BT601	3020000110	Battery CR2032	1
MP301*	8510015390	2591 REG plate	1

[VR-A BOARD]

REF. NO.	ORDER NO.	DESCRIPTION	QTY.
R1	7210002890	Variable resistor RK161221005J [MAIN NB/NR]	1
R2	7210002890	Variable resistor RK161221005J [SUB NB/NR]	1
R3	7210002890	Variable resistor RK161221005J [MAIN AF/RF]	1
R4	7210002890	Variable resistor RK161221005J [SUB AF/RF]	1

[VR-B BOARD]

REF. NO.	ORDER NO.	DESCRIPTION	QTY.
R1	7210003160	Variable resistor RV-317 [MIC/RF PWR]	1
R2	7210003160	Variable resistor RV-317 [MAIN AGC/SQ]	1

[VR-C BOARD]

REF. NO.	ORDER NO.	DESCRIPTION	QTY.
R1	7210003160	Variable resistor RV-317 [KEY SPEED/DELAY]	1
R2	7210003160	Variable resistor RV-317 [SUB AGC SQL]	1

[VR-D BOARD]

REF. NO.	ORDER NO.	DESCRIPTION	QTY.
R1	7210001130	Variable resistor RK097111T005A [BRIGHT]	1
R2*	7210001130	Variable resistor RK097111T005A[CONTRAST]	1
R3*	7210001130	Variable resistor RK097111T005A [ANTI VOX]	1
R4*	7210001130	Variable resistor RK097111T005A [VOX GAIN]	1
R5*	7210001130	Variable resistor RK097111T005A [DRIVE]	1
R6*	7210001130	Variable resistor RK097111T005A [COMP]	1
R7*	7210001130	Variable resistor RK097111T005A[MONI GAIN]	1

[JACK BOARD]

REF. NO.	ORDER NO.	DESCRIPTION	QTY.
J2	6510023890	Connector S-G4617#01 [PHONES]	1
J102	6510023900	Connector LGR4619-7000 [ELEC-KEY]	1

[MIC BOARD]

REF. NO.	ORDER NO.	DESCRIPTION	QTY.
J1	6510000190	Connector FM214-8SS (P) [MIC]	1

[PBT1 BOARD]

REF. NO.	ORDER NO.	DESCRIPTION	QTY.
R1	7210003180	Variable resistor RV-319 [MAIN DIGI-SEL/NOTCH]	1
S1	2250000410	Switch TP90D96E20-30F-2178-1 [MAIN TWIN PBT]	1

[PBT2 BOARD]

REF. NO.	ORDER NO.	DESCRIPTION	QTY.
R1	7210003180	Variable resistor RV-319 [SUB DIGI-SEL/NOTCH]	1
R2	7210003170	Variable resistor RV-318 [CW PITCH]	1
S1	2250000410	Switch TP90D96E20-30F-2178-1 [SUB TWIN PBT]	1

*Refer to SECTION 8 BOARD LAYOUTS.

[DIGISEL UNIT]

REF. NO.	ORDER NO.	DESCRIPTION	QTY.
MP1	8930061600	2590 DIGISEL spring	1
MP2	8930061600	2590 DIGISEL spring	1
MP3	8930061600	2590 DIGISEL spring	1
MP4	8930061600	2590 DIGISEL spring	1
MP5	8510015840	2590 D-SHIELD plate	1
MP6	8930014140	Earth spring (D)	1
MP7	8930014140	Earth spring (D)	1
MP8	8510016020	2590 DIGISEL case	1
MP9	8110008060	2590 DIGISEL cover	1
MP10	8930014140	Earth spring (D)	1
MP11	8930014140	Earth spring (D)	1
MP12	8930014140	Earth spring (D)	1
MP13	8930014140	Earth spring (D)	1
MP14	8810007230	Setscrew H M3 • 8	8
MP15	8810008660	Screw PH BT M3 • 8 NI-ZU	1

[OSC UNIT]

REF. NO.	ORDER NO.	DESCRIPTION	QTY.
MP1	8510015821	2590 OSC case-1	1
MP2	8110008050	2590 OSC cover	1
MP3	8810008660	Screw PH BT M3 • 8 NI-ZU	4
MP4	8810008660	Screw PH BT M3 • 8 NI-ZU	4

[ANT-SW UNIT]

REF. NO.	ORDER NO.	DESCRIPTION	QTY.
J51	6510000410	Connector MR-DS-E 02 [ANT1]	1
J61	6510000410	Connector MR-DS-E 02 [ANT2]	1
J71	6510000410	Connector MR-DS-E 02 [ANT3]	1
J81	6510000410	Connector MR-DS-E 02 [ANT4]	1

[PA UNIT]

REF. NO.	ORDER NO.	DESCRIPTION	QTY.
MF1	2710000770	Fan FCB34AC12A	1
W1	8900012790	Cable OPC-1299	1
MP1	8820000700	1129 screw	4
MP3	8930061230	2590 FL-PA angle	1
MP4	8930061240	2590 FR-PA angle	1
MP5	8930061260	2590 L-fan angle	1
MP6	8510015990	2590 PA cover	1
MP7	8410002550	2590 PA heatsink	1
MP8	8930062120	2590 PA sheet	1
MP9	8930061250	2590 R-fan angle	1
MP10	8930061221	2590 R-PA angle-1	1
MP11	8930061430	2590 rubber	4
MP12	8930062210	Thermally sheet (AL)	1
MP13	8810009040	Setscrew H M2.6 • 10 NI	6
MP14	8810007230	Setscrew H M3 • 8	10
MP15	8810008660	Screw PH BT M3 • 8 NI-ZU	8
MP16	8810008660	Screw PH BT M3 • 8 NI-ZU	5
MP17	8810008660	Screw PH BT M3 • 8 NI-ZU	1
MP18	8810008660	Screw PH BT M3 • 8 NI-ZU	1
MP19	6910008240	Clip 59TN4772	1
MP20	8930063150	Thermally sheet (AR)	2

[MAIN UNIT]

REF. NO.	ORDER NO.	DESCRIPTION	QTY.
F3	5210000040	Fuse FGB 2A	1
J1*	6510023670	Connector TCS4480-01-4151 [MAIN ACC (1)]	1
J2*	6510023660	Connector TCS4470-01-4151 [MAIN ACC (2)]	1
J3*	6510023670	Connector TCS4480-01-4151 [SUB ACC (1)]	1
J4*	6510023660	Connector TCS4470-01-4151 [SUB ACC (2)]	1
J5*	6450001130	Connector JPJ2042-01-110 [RELAY/ALC]	1
J6*	6510023730	Connector LGY6502-0600C [METER]	1
J7*	6510023730	Connector LGY6502-0600C [EXT KEYPAD]	1
J8*	6510023740	Connector LGR4609-7000 [KEY]	1
J9*	6510023070	Connector HEC2305-01-250 [DC OUT]	1
J140*	6510023720	Connector LGY6501-0600C [EXT-SP MAIN]	1
J141*	6510023720	Connector LGY6501-0600C [EXT-SP SUB]	1
J490	6510023750	Connector 01K1971-10 [REF I/O]	1
J495*	6510023700	Connector TORX178S [S/P DIF IN]	1
J496*	6510023710	Connector TOTX178S [S/P DIF OUT]	1
MP496	8930062740	2590 M-spring	1
MP501	8930014140	Earth spring (D)	1
MP502*	8510015800	2590 2LO case	1
MP511*	8510015900	2590 M-2LO case	1
MP551	8930014140	Earth spring (D)	1
MP801	8930014140	Earth spring (D)	1

[DSP-A BOARD]

REF. NO.	ORDER NO.	DESCRIPTION	QTY.
MP1	8510014140	2432 DSP cover	1
MP2	8510016110	2590 M-DSP case	1
MP3*	8930062220	Thermally sheet (AO)	1
MP4	8930055051	Thermally sheet (V)-1	2

[DSP-B BOARD]

REF. NO.	ORDER NO.	DESCRIPTION	QTY.
MP1	8510014140	2432 DSP cover	1
MP2	8510016110	2590 M-DSP case	1
MP3*	8930062220	Thermally sheet (AO)	1
MP4	8930055051	Thermally sheet (V)-1	2

[DSP-TX BOARD]

REF. NO.	ORDER NO.	DESCRIPTION	QTY.
MP1	8510014140	2432 DSP cover	1
MP2	8510016110	2590 M-DSP case	1
MP3*	8930062220	Thermally sheet (AO)	1
MP4	8930055051	Thermally sheet (V)-1	2

[MEMORY BOARD]

REF. NO.	ORDER NO.	DESCRIPTION	QTY.
MP1	8930028840	Sponge (DF)	1
MP2	8930028840	Sponge (DF)	1

Screw abbreviations BT: Self-tapping PH: Pan head
 FH: Flat head BiH: Binding head
 ZK: Black BS: Brass
 NI: Nickel SUS: Stainless
 NI-ZU: Nickel-Zinc

*Refer to SECTION 8 BOARD LAYOUTS.

[SCOPE UNIT]

REF. NO.	ORDER NO.	DESCRIPTION	QTY.
J902	6510023120	Connector CD6109SA1J0 [RS-232C]	1
J903	6510024040	Connector TM11R-5M2-88-LP [LAN]	1
J904	6510024030	Connector UBA-4R-D10T-1 [USB]	1
J905	6450001940	Connector KEY-15S-2A3A[EXT MONITOR]	1
MP3	8930014140	Earth spring (D)	1
MP101*	8510015810	2590 MIX case	1
MP301*	8510015810	2590 MIX case	1
MP601*	8510015770	2590 DSP case	1
MP701*	8510015880	2590 S2LO case	1
MP801*	8510015891	2590 S3LO case-1	1
MP802*	8510014870	2577 RX-VCO case	1
MP901	8850001860	Flat washer M3 (3 • 6 • 0.5) SUS	2
MP902	8850000420	Spring washer M3 NI	2

[DC-DC UNIT]

REF. NO.	ORDER NO.	DESCRIPTION	QTY.
W1	8900012780	Cable OPC-1298	1
MP21*	8510015720	2590 DC-DC A-case	1
MP22	8510015730	2590 DC-DC A-plate	1
MP41*	8510015720	2590 DC-DC A-case	1
MP42	8510015730	2590 DC-DC A-plate	1
MP61*	8510015720	2590 DC-DC A-case	1
MP62	8510015730	2590 DC-DC A-plate	1
MP81*	8510015720	2590 DC-DC A-case	1
MP82	8510015730	2590 DC-DC A-plate	1
MP101*	8510015720	2590 DC-DC A-case	1
MP102	8510015730	2590 DC-DC A-plate	1
MP121*	8510015740	2590 DC-DC B-case	1
MP122	8510015750	2590 DC-DC B-plate	1

[RXPLL-A UNIT]

REF. NO.	ORDER NO.	DESCRIPTION	QTY.
MP1*	8930039710	Rubber sheet (V)	2
MP101*	8510010760	1876 DDS case	1
MP102	8510010770	1876 DDS cover	1
MP103*	8510010850	1897 D/A case	1
MP151*	8510013510	2355 VCO case	1
MP201*	8510013510	2355 VCO case	1
MP221*	8510015780	2590 VCO case	1
MP222	8510015790	2590 VCO cover	1
MP223	8810007230	Setscrew H M3 • 8	4
MP224	8930062300	Rubber sheet (Bl)	1
MP301*	8930014140	Earth spring (D)	1
MP501*	8510010760	1876 DDS case	1
MP502	8510010770	1876 DDS cover	1
MP503*	8510010850	1897 D/A case	1
MP541*	8510011970	2177 OSC case	1
MP542	8510011960	2177 OSC cover	1
MP601*	8930014140	Earth spring (D)	1
MP651*	8510005980	724 shield case	1
MP652	8510005990	724 shield case cover	1
MP1058*	6910001130	10M shield case	1
MP1101*	8510016060	2590 HF case	1
MP1102	8510015910	2590 HF cover	1
MP1103	8930020860	IC-holder	2
MP1104	8930049850	2240 D-sponge 3.5 • 5 • 50	1
MP1301*	8510016050	2590 50M case	1
MP1302*	8930014140	Earth spring (D)	1
MP1408*	6910001130	10M shield case	1
MP1501*	8930014140	Earth spring (D)	1
MP1502*	8930014140	Earth spring (D)	1
MP1503*	8930014140	Earth spring (D)	1
MP1504*	8930014140	Earth spring (D)	1
MP1651*	8510016340	2590 2MIX case	1
MP1652*	8510016390	2590 shield plate	1
MP1653*	8930024170	Earth spring (G)	1
MP1654*	8930058170	Shield sponge (O)	1

[RXPLL-B UNIT]

REF. NO.	ORDER NO.	DESCRIPTION	QTY.
MP1*	8930039710	Rubber sheet (V)	2
MP101*	8510010760	1876 DDS case	1
MP102	8510010770	1876 DDS cover	1
MP103*	8510010850	1897 D/A case	1
MP151*	8510013510	2355 VCO case	1
MP201*	8510013510	2355 VCO case	1
MP221*	8510015780	2590 VCO case	1
MP222	8510015790	2590 VCO cover	1
MP223	8810007230	Setscrew H M3 • 8	4
MP224	8930062300	Rubber sheet (Bl)	1
MP301*	8930014140	Earth spring (D)	1
MP501*	8510010760	1876 DDS case	1
MP502	8510010770	1876 DDS cover	1
MP503*	8510010850	1897 D/A case	1
MP541*	8510011970	2177 OSC case	1
MP542	8510011960	2177 OSC cover	1
MP543*	8510005070	599 shield plate	1
MP544*	8930030940	Enboss tape (D)	1
MP545*	8930030940	Enboss tape (D)	1
MP546*	8930027810	Enboss tape (B)	1
MP601*	8930014140	Earth spring (D)	1
MP651*	8510005980	724 shield case	1
MP652	8510005990	724 shield case cover	1
MP1058*	6910001130	10M shield case	1
MP1101*	8510016060	2590 HF case	1
MP1102	8510015910	2590 HF cover	1
MP1103	8930020860	IC-holder	2
MP1104	8930049850	2240 D-sponge 3.5 • 5 • 50	1
MP1301*	8510016050	2590 50M case	1
MP1302*	8930014140	Earth spring (D)	1
MP1408*	6910001130	10M shield case	1
MP1501*	8930014140	Earth spring (D)	1
MP1502*	8930014140	Earth spring (D)	1
MP1503*	8930014140	Earth spring (D)	1
MP1504*	8930014140	Earth spring (D)	1
MP1651*	8510016340	2590 2MIX case	1
MP1652*	8510016390	2590 shield plate	1
MP1653*	8930024170	Earth spring (G)	1
MP1654*	8930058170	Shield sponge (O)	1

[LOGIC UNIT]

REF. NO.	ORDER NO.	DESCRIPTION	QTY.
MP101*	8510016490	2590 LOGIC B-plate	1
MP103*	8930063300	AL sheet (AK)	1
MP201*	8510016480	2590 LOGIC C-plate	1
MP203*	8510016500	2590 LOGIC A-plate	1
MP204*	8930063320	2590 A-sheet (top side of MP203)	1
MP205*	8930063310	2590 B-sheet (bottom side of MP203)	1
MP801*	8510005350	VCO shield plate	1

Screw abbreviations BT: Self-tapping PH: Pan head
 FH: Flat head BiH: Binding head
 ZK: Black BS: Brass
 NI: Nickel SUS: Stainless
 NI-ZU: Nickel-Zinc

*Refer to SECTION 8 BOARD LAYOUTS.

[REG UNIT]

REF. NO.	ORDER NO.	DESCRIPTION	QTY.
EP1	6910015660	REG unit FP2212A [JPN]	1
	6910016050	REG unit FP2212B [USA]	1
	6910016060	REG unit FP2212C [OTHER]	1
MP9000	8850001691	Insulation flat washer (X)-1	1

[BPF UNIT]

REF. NO.	ORDER NO.	DESCRIPTION	QTY.
J103	6510023750	Connector 01K1971-10 [X-VERTER]	1
J104	6510023750	Connector 01K1971-10 [RXANT INA]	1
J105	6510023750	Connector 01K1971-10 [RXANT OUTA]	1
J504	6510023750	Connector 01K1971-10 [RXANT INB]	1
J505	6510023750	Connector 01K1971-10 [RXANT OUTB]	1

[TUNER UNIT]

REF. NO.	ORDER NO.	DESCRIPTION	QTY.
MF1	2710000780	Motor MP24Z	1
MF2	2710000780	Motor MP24Z	1
MF3	2710000470	Fan MF60B-12H901	1
MP1	8950003200	Universal couplings UJ6-5	2
MP2	8930030111	1414 plate-1	2
MP3	8820000880	1528 screw	4
MP4	8930061271	2590 motor angle-1	1
MP5	8510015831	2590 TUNER case-1	1
MP6	8510015870	2590 TUNER cover	1
MP7	8810005160	Cap bolt M3 X 20 ZK	4
MP8	8810007230	Setscrew H M3 • 8	6
MP9	8810007230	Setscrew H M3 • 8	4
MP10	8810008660	Screw PH BT M3 • 8 NI-ZU	6
MP11	8810008660	Screw PH BT M3 • 8 NI-ZU	6
MP12	8810008660	Screw PH BT M3 • 8 NI-ZU	4
MP13	8850000130	Flat washer M3 (3 • 8 • 0.5) NI BS	4
MP14	8930006960	Sponge (Y)	1
MP15	8930059520	Nonwovens sheet (CG)	1
MP16	8930058760	Shield sponge (S)	1
MP17	8930005170	Aluminum sheet (F)	1

[CTRL BOARD]

REF. NO.	ORDER NO.	DESCRIPTION	QTY.
MP1*	8510015760	2590 A-CTRL case	1
MP2	8930014140	Earth spring (D)	1

[NETWORK BOARD]

REF. NO.	ORDER NO.	DESCRIPTION	QTY.
MP1	8510011480	1900 AL cover	1

[ACCESSORIES]

REF. NO.	ORDER NO.	DESCRIPTION	QTY.
EP1	0800007460	CF card SDCFB-64-101	1
F1	5210000040	Fuse FGB 2A	1
W1	8900005260	AC power cable OPC-511 [JPN]	1
	8900005250	AC power cable OPC-510 [USA], [KOR]	1
	8900005220	AC power cable OPC-513 [AUS]	1
	8900005120	AC power cable OPC-491 [UK]	1
	8900005130	AC power cable OPC-492 [OTHER]	1
W2	8900012770	Jumper cable OPC-1243	2
P1	5610000050	Key plug AP-330 [CW]	3
P2	5610000020	Speaker plug AP-313 [MONORAL]	3
P3	5610000170	Speaker plug AP-370 [STEREO]	2
J1	6510023200	Pin plug P030010	2
J2	5610000280	DC power plug MP-121M4	1
J3	6450001270	ACC plug TCP0577-71-5201 [7-pin]	2
J4	6450001280	ACC plug TCP0587-71-5401 [8-pin]	2
MP1	8930061400	Rack mounting angle (A)	2
MP2	8810006110	Screw FH M4 • 9 ZK	4
MP3	8810010280	Screw FH M4 • 15 ZK	2
MP4	8930061360	2590 sub stand	2
MP5	8930061840	2590 A-stand sheet	2

Screw abbreviations BT: Self-tapping PH: Pan head
 FH: Flat head BiH: Binding head
 ZK: Black BS: Brass
 NI: Nickel SUS: Stainless
 NI-ZU: Nickel-Zinc

*Refer to SECTION 8 BOARD LAYOUTS.

• WIRE CONNECTION INFORMATION

WIRE No.	CONNECTION1	CONNECTION2
A	DISPLAY BOARD J203	LOGIC UNIT J805
B	DISPLAY BOARD J3	SW-A BOARD J3
C	DISPLAY BOARD J6	VR-A BOARD J1
D	DISPLAY BOARD J302	CF BOARD J3
E	DISPLAY BOARD J5	VR-D BOARD J1
F	DISPLAY BOARD J301	LCD UNIT
G	DISPLAY BOARD J4	SW-B BOARD J1
H	DISPLAY BOARD J205	FRONT UNIT EP11
I	DISPLAY BOARD J1	TENKEY BOARD J1
J	DISPLAY BOARD J205	TENKEY BOARD J2
K	DISPLAY BOARD J202	LOGIC UNIT J806
L	DISPLAY BOARD J201	LCD UNIT
M	TENKEY BOARD J5	LED BOARD J1
N	TENKEY BOARD J4	PBT1 BOARD J1
O	TENKEY BOARD J3	SW-C BOARD J1
P	TENKEY BOARD J7	FRONT UNIT EP13
Q	TENKEY BOARD J6	FRONT UNIT EP12
R	PBT2 BOARD J1	SW-C BOARD J2
S	SW-A BOARD J1	VR-B BOARD J1
T	SW-A BOARD J2	VR-C BOARD J1
U	VR-A BOARD J3	JACK BOARD J1
V	VR-A BOARD J4	MIC BOARD J2
W	VR-A BOARD J2	MAIN UNIT J440
X	CF BOARD J1	LOGIC UNIT J807

WIRE No.	CONNECTION1	CONNECTION2
1	LOGIC UNIT J826	MAIN UNIT J901
2	LOGIC UNIT J810	MAIN UNIT J451
3	LOGIC UNIT J815	RXPLL-B UNIT J2
4	LOGIC UNIT J814	OSC UNIT UNIT J2
5	LOGIC UNIT J813	DIGISEL UNIT J10
6	LOGIC UNIT J816	RXPLL-A UNIT J2
7	LOGIC UNIT J808	MAIN UNIT J940
8	LOGIC UNIT J809	MAIN UNIT J900
10	LOGIC UNIT J825	SCOPE UNIT J910
11	MAIN UNIT J400	RXPLL-A UNIT J1701
12	MAIN UNIT J450	DC-DC UNIT J2
13	LOGIC UNIT J802	SCOPE UNIT J907
14	MAIN UNIT J492	CHASSIS UNIT MF1
15	LOGIC UNIT J822	MAIN UNIT J142
16	MAIN UNIT J401	RXPLL-A UNIT J1501
17	MAIN UNIT J399	RXPLL-B UNIT J681
18	MAIN UNIT J503	RXPLL-A UNIT J421
19	MAIN UNIT J801	PA200W BOARD J1
20	MAIN UNIT J808	SCOPE UNIT J11
21	MAIN UNIT J403	RXPLL-B UNIT J1701
22	MAIN UNIT J502	RXPLL-A UNIT J561
23	MAIN UNIT J501	RXPLL-A UNIT J681
24	MAIN UNIT J491	OSC UNIT UNIT J71
25	MAIN UNIT J410	SCOPE UNIT J4
26	MAIN UNIT J430	PA200W BOARD J2
27	MAIN UNIT J411	SCOPE UNIT J906
28	RXPLL-A UNIT J1002	DIGISEL UNIT J10
29	RXPLL-A UNIT J601	RXPLL-A UNIT J1001
30	SCOPE UNIT J1	RXPLL-A UNIT J1301
31	RXPLL-A UNIT J351	RXPLL-A UNIT J1101
32	RXPLL-A UNIT J1002	OSC UNIT UNIT J72
33	RXPLL-B UNIT J1002	DIGISEL UNIT J501
34	SCOPE UNIT J2	RXPLL-B UNIT J1301
35	RXPLL-B UNIT J351	RXPLL-B UNIT J1101
36	SCOPE UNIT J3	RXPLL-B UNIT J601
37	RXPLL-B UNIT J561	RXPLL-B UNIT J831
38	RXPLL-B UNIT J1002	OSC UNIT UNIT J73
39	MAIN UNIT J404	RXPLL-B UNIT J1501
40	PA200W BOARD J5	DC-DC UNIT J5
41	DC-DC UNIT W1	REG UNIT
42	FILTER UNIT J901	PA200W BOARD J401
43	FILTER UNIT J903	ANT-SW J4
44	CTRL BOARD J252	NETWORK BOARD J3
45	CTRL BOARD J251	NETWORK BOARD J2
46	ANT-SW UNIT J1	CTRL BOARD J301
47	CTRL BOARD J351	BPF UNIT J106
48	LOGIC UNIT J811	CTRL BOARD J1
49	FILTER UNIT J904	CTRL BOARD J101
50	FILTER UNIT J905	CTRL BOARD J53
51	FILTER UNIT J902	CTRL BOARD J52
52	DIGISEL UNIT J2	BPF UNIT J101
53	LOGIC UNIT J812	BPF UNIT J1
54	DIGISEL UNIT J502	BPF UNIT J601
55	RXPLL-A UNIT J1201	BPF UNIT J102
56	ANT-SW UNIT J3	BPF UNIT J108
57	RXPLL-B UNIT J1201	BPF UNIT J602
58	MAIN UNIT J802	BPF UNIT J107
59	CTRL BOARD J51	NETWORK BOARD J1
60	LOGIC UNIT J824	PA UNIT MF1
61	LOGIC UNIT J823	CHASSIS UNIT SP1
62	LOGIC UNIT J820	DC-DC UNIT J4
63	LOGIC UNIT J821	DC-DC UNIT J3
65	LOGIC UNIT J803	SCOPE UNIT J909
66	LOGIC UNIT J804	SCOPE UNIT J908
68	CTRL BOARD J2	TUNER UNIT MF1/2
69	NETWORK BOARD J4	TUNER UNIT MF3
70	PA UNIT EP501/EP502	REG UNIT
71	ANT-SW J2	BPF UNIT J506

• FRONT UNIT

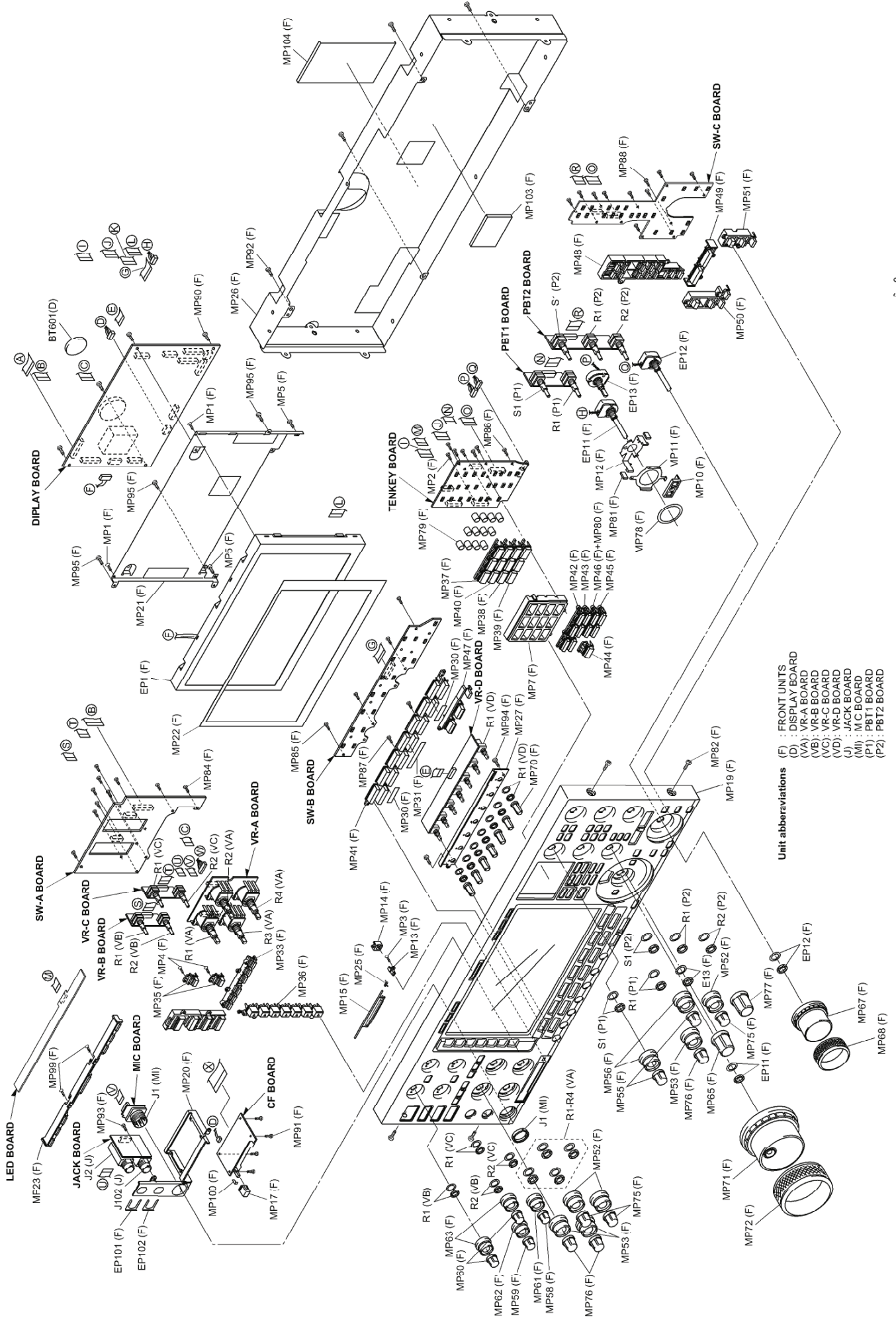

- Unit abbreviations**
- (F) : FRONT UNITS
 - (D) : DISPLAY BOARD
 - (VA) : VR-A BOARD
 - (VB) : VR-B BOARD
 - (VC) : VR-C BOARD
 - (VD) : VR-D BOARD
 - (J) : JACK BOARD
 - (MI) : M/C BOARD
 - (P1) : PBT1 BOARD
 - (P2) : PBT2 BOARD

• FRONT AND BOTTOM SIDE

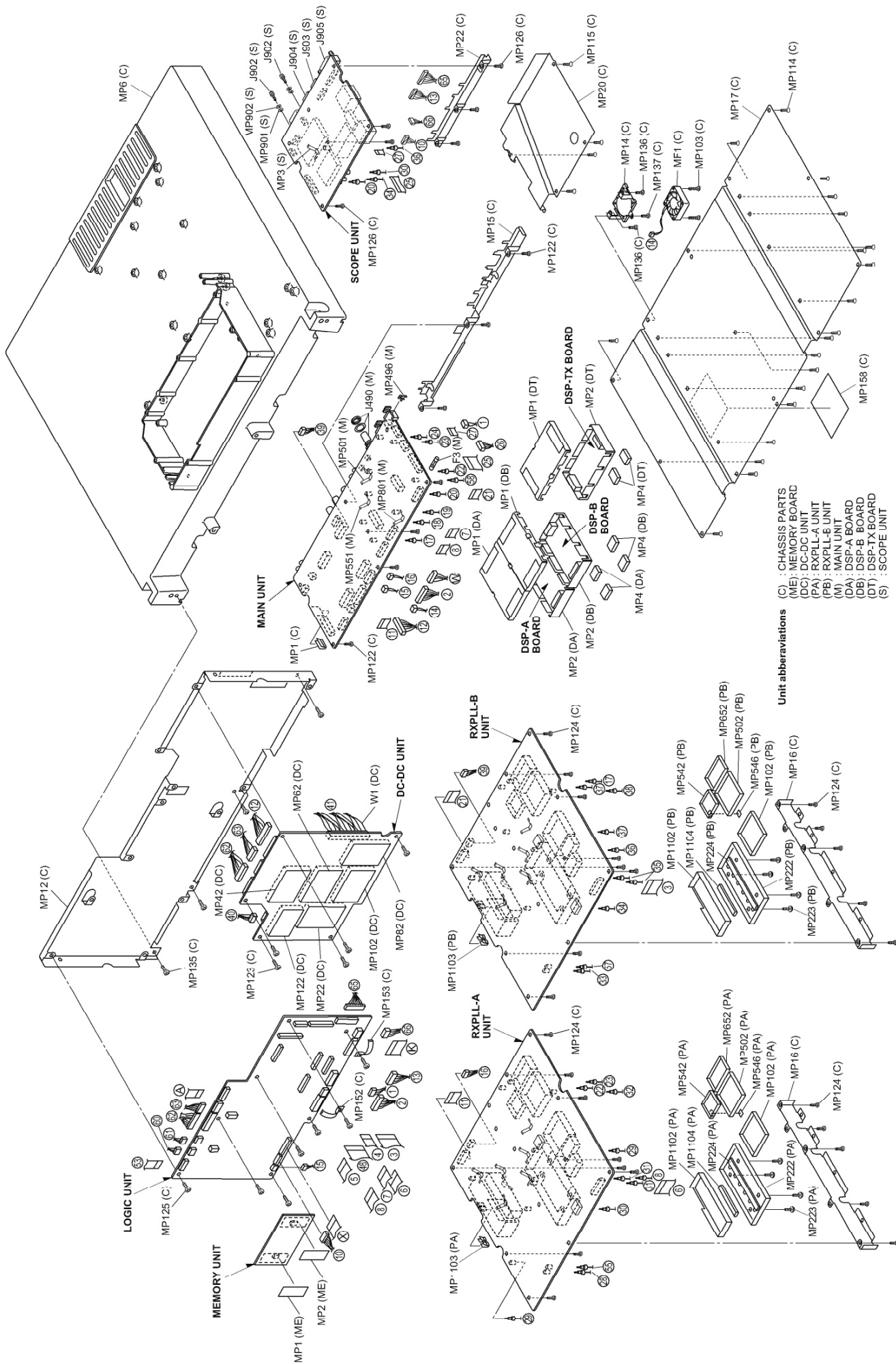

• REG, BPF AND TUNER UNITS

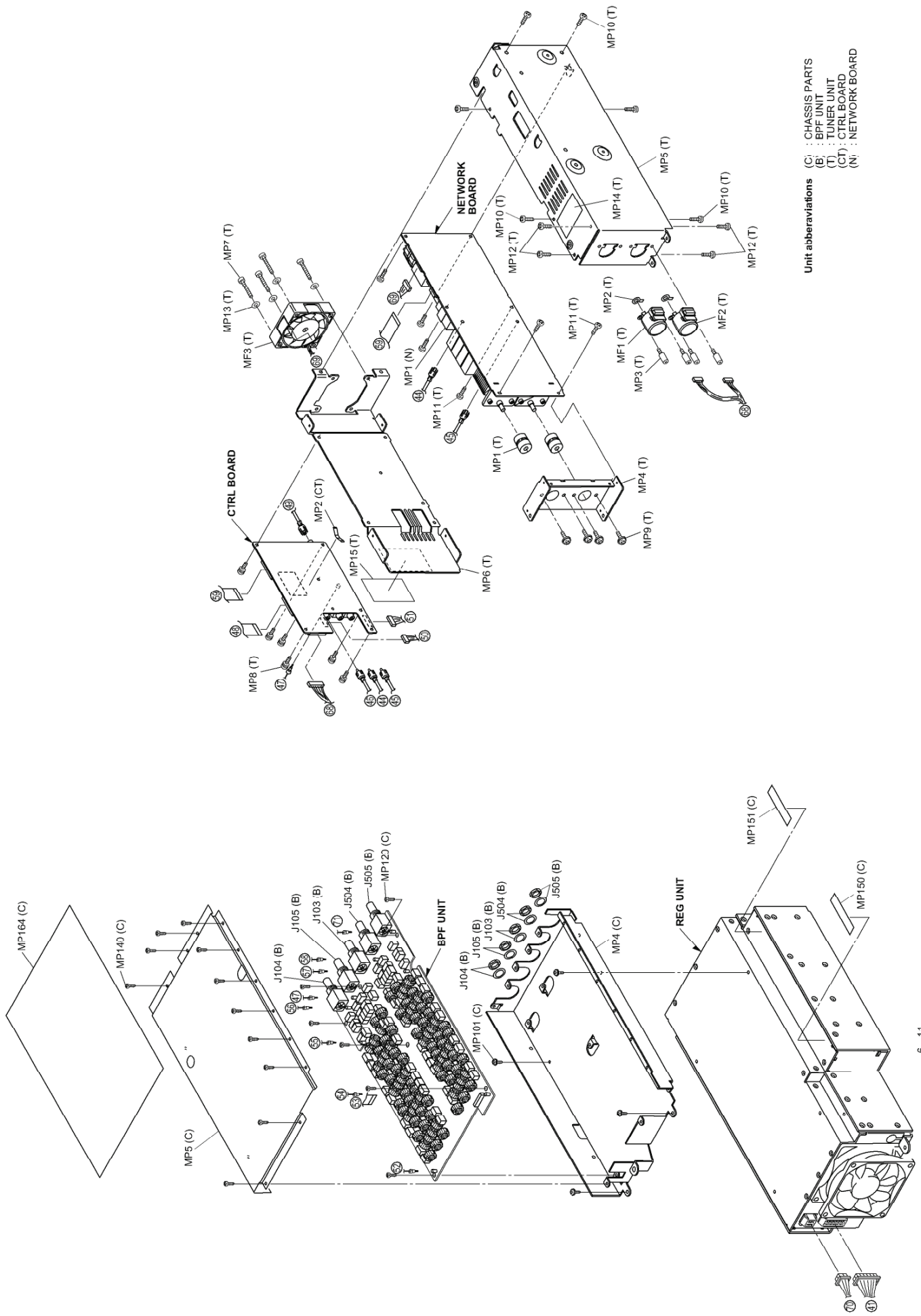



SECTION 7 SEMI-CONDUCTOR INFORMATION

• TRANSISTORS AND FETs

2SA1162 GR (Symbol: SG)		2SB1123 T TD (Symbol: BF)		2SB1132 T100 R (Symbol: BAR)	
2SB1201 S (Symbol: B1201)		2SC3960D (Symbol: 2042B)		2SC4081 T106 R (Symbol: BR)	
2SC4081 T106 S (Symbol: BS)		2SC4116 Y (Symbol: LY)		2SC402 3 TL (Symbol: PT3)	
2SC406 (Symbol: JT)		2SC4835 R (Symbol: 3M)		2SC5501 4 TR (Symbol: LN4)	
2SC5551 (Symbol: EB)		2SD1664 T100Q (Symbol: DAQ)		2SJ144 GR (Symbol: VG)	
2SK210 GR (Symbol: YG)		2SK880 GR (Symbol: XG)		2SK3018 T106 (Symbol: KN)	
3SK234 (Symbol: UV)		CPH3403 TL (Symbol: KC)		DTC1144EUA T106 (Symbol: 24)	

DTC114TUA T106 (Symbol: O4)		DTC144 TE (Symbol: O6)		MMBFU316LT1 (Symbol: GC)	
DTC144EUA T106 (Symbol: 2E_)		DTC113ZK (Symbol: G21)		SD2918 (Symbol: M174)	
RD01MUS1 (Symbol: K2)		RD2427 (Symbol: R6)		SD2918 (Symbol: M113)	
UMH11N TN (Symbol: H11)		PD56003 (Symbol: PD56003)		XP4311 (Symbol: 3X)	

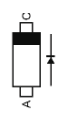
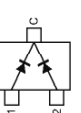
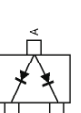
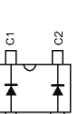
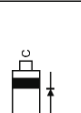
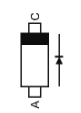
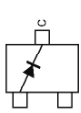
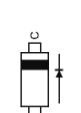
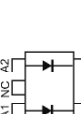
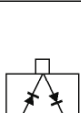
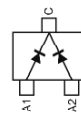
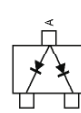
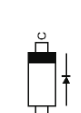
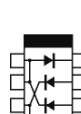
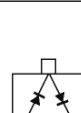
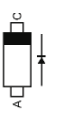
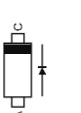
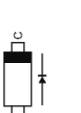
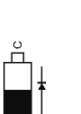
• DIODES

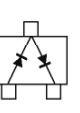
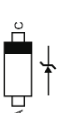
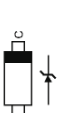
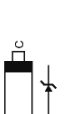
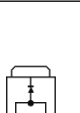
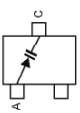
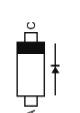
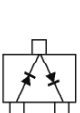
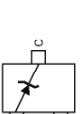
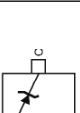
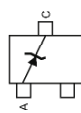
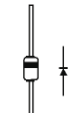
<p>1SR134-400 (Symbol: 14)</p> 	<p>1SS391 (Symbol: B3)</p> 	<p>1SS312 (Symbol: BF)</p> 	<p>1SS319 (Symbol: A4)</p> 	<p>1SS335 (Symbol: A)</p> 
<p>1SV232 (Symbol: T9)</p> 	<p>1SV263 TL (Symbol: JV)</p> 	<p>1SV307 (Symbol: TX)</p> 	<p>CPH513 TL (Symbol: 2B)</p> 	<p>DA221 TL (Symbol: K)</p> 
<p>DAN22TL (Symbol: N)</p> 	<p>DAP22 TL (Symbol: P)</p> 	<p>DSM3A4 (Symbol: SA4)</p> 	<p>HSB8WSTR (Symbol: Silver line)</p> 	<p>HSM8AS TR (Symbol: C1)</p> 
<p>MA114 (Symbol: 1E)</p> 	<p>MA2511 (Symbol: A)</p> 	<p>MA25728 (Symbol: B)</p> 	<p>MA77 (Symbol: 4B)</p> 	<p>MA357 (Symbol: 7K)</p> 
<p>MA742 (Symbol: M1U)</p> 	<p>MA803 H (Symbol: 3*3)</p> 	<p>MA8047 M (Symbol: 4-7)</p> 	<p>MA8091 M (Symbol: 9-1)</p> 	<p>MBRC35LT4 (Symbol: B635L)</p> 
<p>MMBY3700LT1 (Symbol: 4R)</p> 	<p>RB081L-20 (Symbol: 39)</p> 	<p>RB708F-40 T106 (Symbol: 3J)</p> 	<p>RD27M B1 (Symbol: 271)</p> 	<p>RD51M T2B2 (Symbol: 512)</p> 
<p>RD5.6M T2B2 (Symbol: 562)</p> 	<p>XB15A204</p> 			

SECTION 8 BOARD LAYOUTS

8-1 DISPLAY BOARD • TOP VIEW

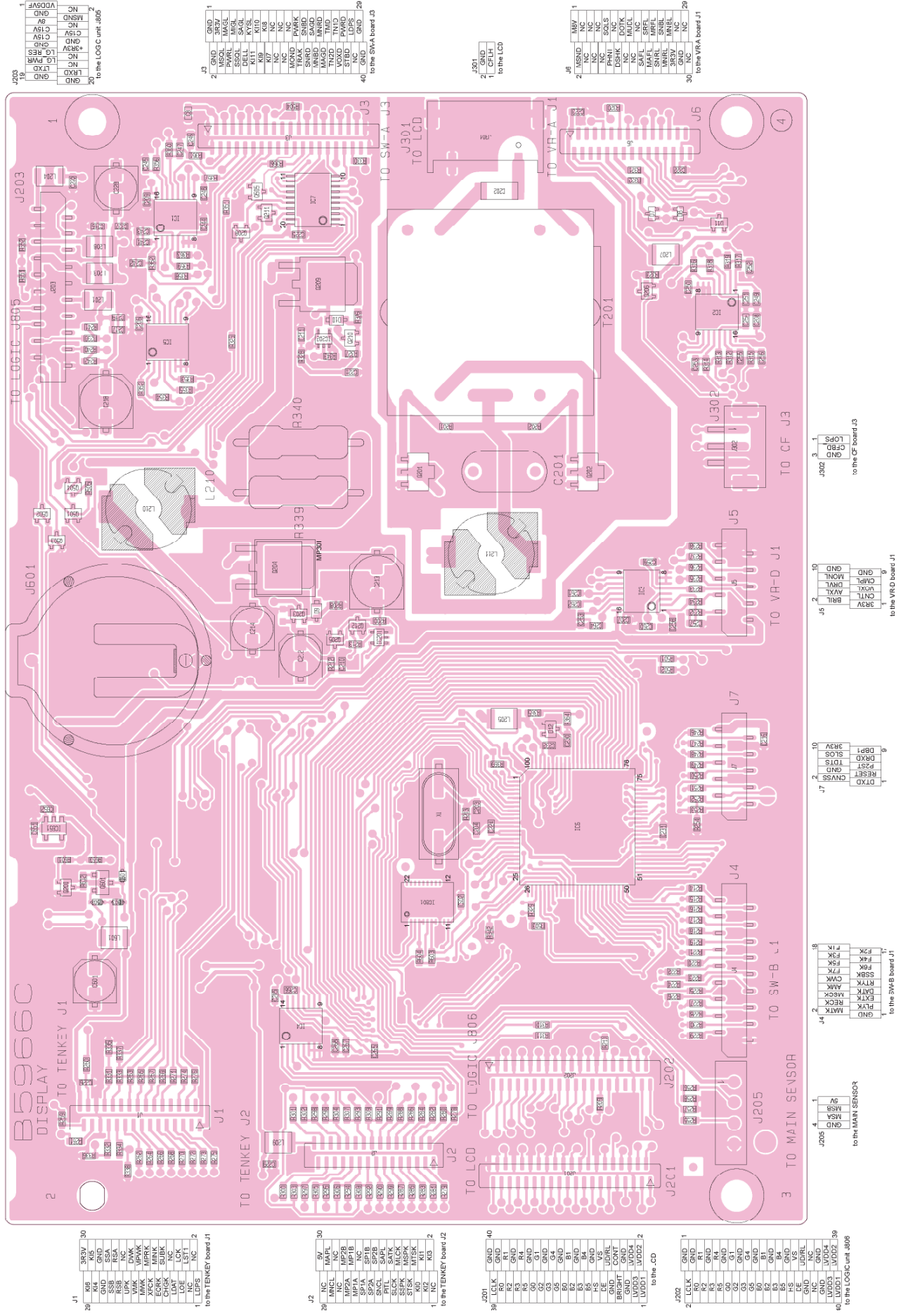

J1

29	K16	3R3V	30
31	GND	GND	
32	MSND	MSND	
33	AV	AV	
34	C15V	C15V	
35	GND	GND	
36	C15V	C15V	
37	AV	AV	
38	MSND	MSND	
39	GND	GND	
40	MSND	MSND	
41	AV	AV	
42	C15V	C15V	
43	GND	GND	
44	C15V	C15V	
45	AV	AV	
46	MSND	MSND	
47	GND	GND	

to the LOGIC unit 4805

J2

1	NC	5V	30
2	NC	MAPL	
3	MAPL	MAPL	
4	NC	MP1B	
5	MP1B	MP1B	
6	MP1A	MP1A	
7	SP2A	SP2B	
8	SP2A	SP2B	
9	PHL	PHL	
10	SLOCK	ALOCK	
11	MSPK	MSPK	
12	STEK	STEK	
13	K10	K10	
14	K15	K15	
15	NC	K15	
16	NC	K15	

to the TENKEY board J2

J3

1	GND	GND	
2	MSND	3R3V	
3	AV	MAPL	
4	MSND	MAPL	
5	MSND	SAGL	
6	K11	K11	
7	K19	K19	
8	NC	K19	
9	NC	NC	
10	NC	TPARK	
11	TPARK	TPARK	
12	SHRD	SHRD	
13	SHRD	SHRD	
14	SHRD	SHRD	
15	TRXD	TRXD	
16	TRXD	TRXD	
17	TRXD	TRXD	
18	TRXD	TRXD	
19	TRXD	TRXD	
20	TRXD	TRXD	
21	TRXD	TRXD	
22	TRXD	TRXD	
23	TRXD	TRXD	
24	TRXD	TRXD	
25	TRXD	TRXD	
26	TRXD	TRXD	
27	TRXD	TRXD	
28	TRXD	TRXD	
29	TRXD	TRXD	
30	TRXD	TRXD	
31	TRXD	TRXD	
32	TRXD	TRXD	
33	TRXD	TRXD	
34	TRXD	TRXD	
35	TRXD	TRXD	
36	TRXD	TRXD	
37	TRXD	TRXD	
38	TRXD	TRXD	
39	TRXD	TRXD	
40	TRXD	TRXD	

to the SW-A J3

J301

1	GND	GND	
2	GND	GND	
3	GND	GND	

to the LCD

J6

1	MRV	MRV	
2	MSND	NC	
3	NC	NC	
4	NC	NC	
5	NC	NC	
6	PHNI	SOIS	
7	DSHK	DOTK	
8	NC	NC	
9	NC	NC	
10	NC	NC	
11	NC	NC	
12	NC	NC	
13	NC	NC	
14	NC	NC	
15	NC	NC	
16	NC	NC	
17	NC	NC	
18	NC	NC	
19	NC	NC	
20	NC	NC	
21	NC	NC	
22	NC	NC	
23	NC	NC	
24	NC	NC	
25	NC	NC	
26	NC	NC	
27	NC	NC	
28	NC	NC	
29	NC	NC	
30	NC	NC	
31	NC	NC	
32	NC	NC	
33	NC	NC	
34	NC	NC	
35	NC	NC	
36	NC	NC	
37	NC	NC	
38	NC	NC	
39	NC	NC	
40	NC	NC	

to the VR-A board J1

J5

1	3R3V	3R3V	
2	AV	AV	
3	MSND	MSND	
4	GND	GND	
5	MSND	MSND	
6	AV	AV	
7	3R3V	3R3V	
8	GND	GND	
9	GND	GND	
10	GND	GND	

to the VR-D board J1

J7

1	DIRD	DIRD	
2	CHRS	CHRS	
3	CHRS	CHRS	
4	CHRS	CHRS	
5	CHRS	CHRS	
6	CHRS	CHRS	
7	CHRS	CHRS	
8	CHRS	CHRS	
9	CHRS	CHRS	
10	CHRS	CHRS	
11	CHRS	CHRS	
12	CHRS	CHRS	
13	CHRS	CHRS	
14	CHRS	CHRS	
15	CHRS	CHRS	
16	CHRS	CHRS	
17	CHRS	CHRS	
18	CHRS	CHRS	
19	CHRS	CHRS	
20	CHRS	CHRS	
21	CHRS	CHRS	
22	CHRS	CHRS	
23	CHRS	CHRS	
24	CHRS	CHRS	
25	CHRS	CHRS	
26	CHRS	CHRS	
27	CHRS	CHRS	
28	CHRS	CHRS	
29	CHRS	CHRS	
30	CHRS	CHRS	
31	CHRS	CHRS	
32	CHRS	CHRS	
33	CHRS	CHRS	
34	CHRS	CHRS	
35	CHRS	CHRS	
36	CHRS	CHRS	
37	CHRS	CHRS	
38	CHRS	CHRS	
39	CHRS	CHRS	
40	CHRS	CHRS	

to the CF board J3

J4

1	GND	GND	
2	MTK	MTK	
3	MTK	MTK	
4	MTK	MTK	
5	MTK	MTK	
6	MTK	MTK	
7	MTK	MTK	
8	MTK	MTK	
9	MTK	MTK	
10	MTK	MTK	
11	MTK	MTK	
12	MTK	MTK	
13	MTK	MTK	
14	MTK	MTK	
15	MTK	MTK	
16	MTK	MTK	
17	MTK	MTK	
18	MTK	MTK	
19	MTK	MTK	
20	MTK	MTK	
21	MTK	MTK	
22	MTK	MTK	
23	MTK	MTK	
24	MTK	MTK	
25	MTK	MTK	
26	MTK	MTK	
27	MTK	MTK	
28	MTK	MTK	
29	MTK	MTK	
30	MTK	MTK	
31	MTK	MTK	
32	MTK	MTK	
33	MTK	MTK	
34	MTK	MTK	
35	MTK	MTK	
36	MTK	MTK	
37	MTK	MTK	
38	MTK	MTK	
39	MTK	MTK	
40	MTK	MTK	

to the SW-B J4

J205

1	GND	GND	
2	MSND	MSND	
3	AV	AV	
4	MSND	MSND	
5	AV	AV	
6	MSND	MSND	
7	AV	AV	
8	MSND	MSND	
9	AV	AV	
10	MSND	MSND	
11	AV	AV	
12	MSND	MSND	
13	AV	AV	
14	MSND	MSND	
15	AV	AV	
16	MSND	MSND	
17	AV	AV	
18	MSND	MSND	
19	AV	AV	
20	MSND	MSND	
21	AV	AV	
22	MSND	MSND	
23	AV	AV	
24	MSND	MSND	
25	AV	AV	
26	MSND	MSND	
27	AV	AV	
28	MSND	MSND	
29	AV	AV	
30	MSND	MSND	
31	AV	AV	
32	MSND	MSND	
33	AV	AV	
34	MSND	MSND	
35	AV	AV	
36	MSND	MSND	
37	AV	AV	
38	MSND	MSND	
39	AV	AV	
40	MSND	MSND	

to the LOGIC unit 4805

• BOTTOM VIEW (DISPLAY BOARD)

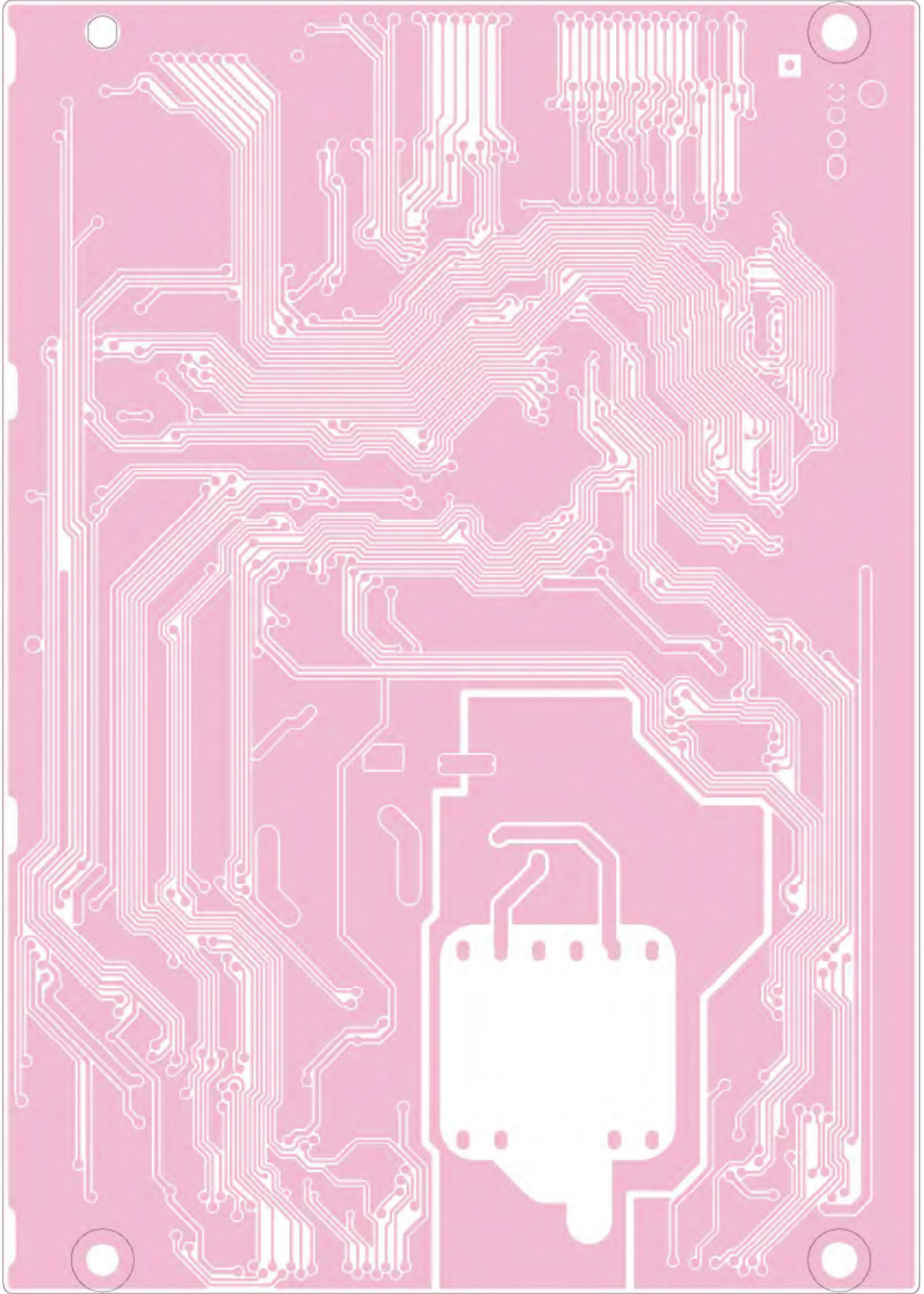

8-2 SW-A BOARD
• TOP VIEW

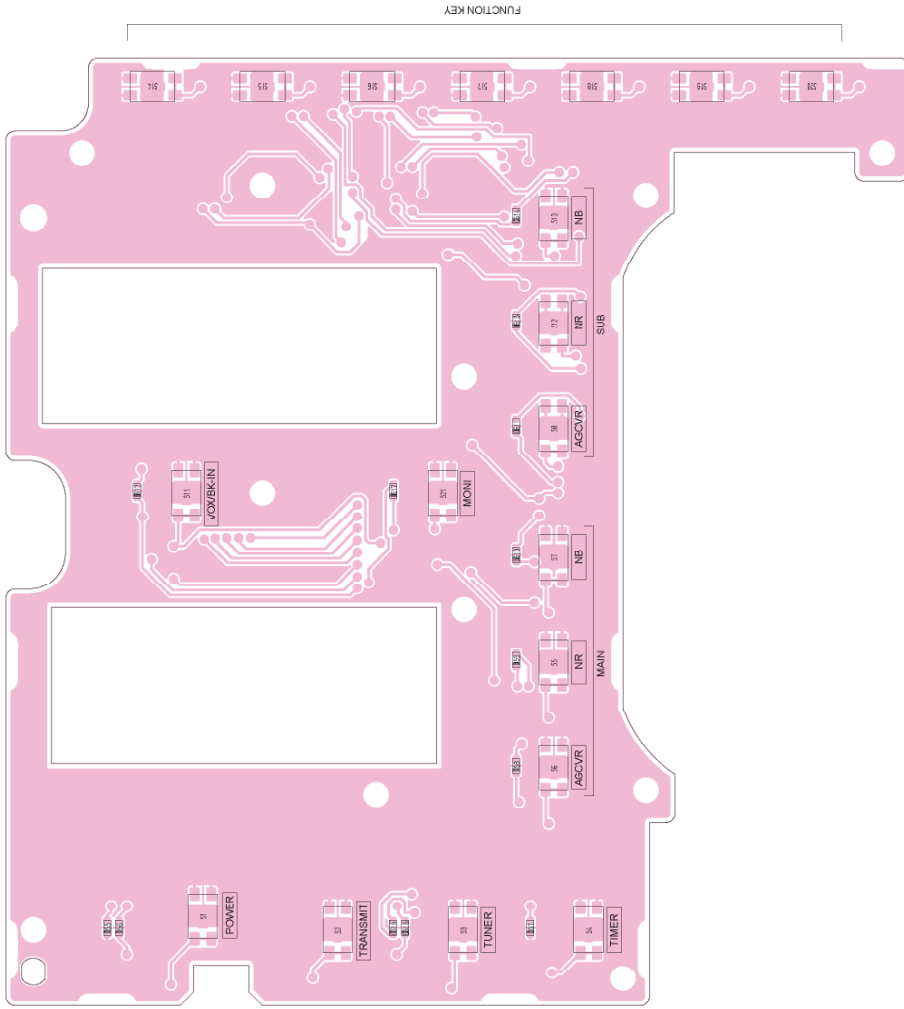

FUNCTION KEY

8-4 SW-C BOARD
• TOP VIEW

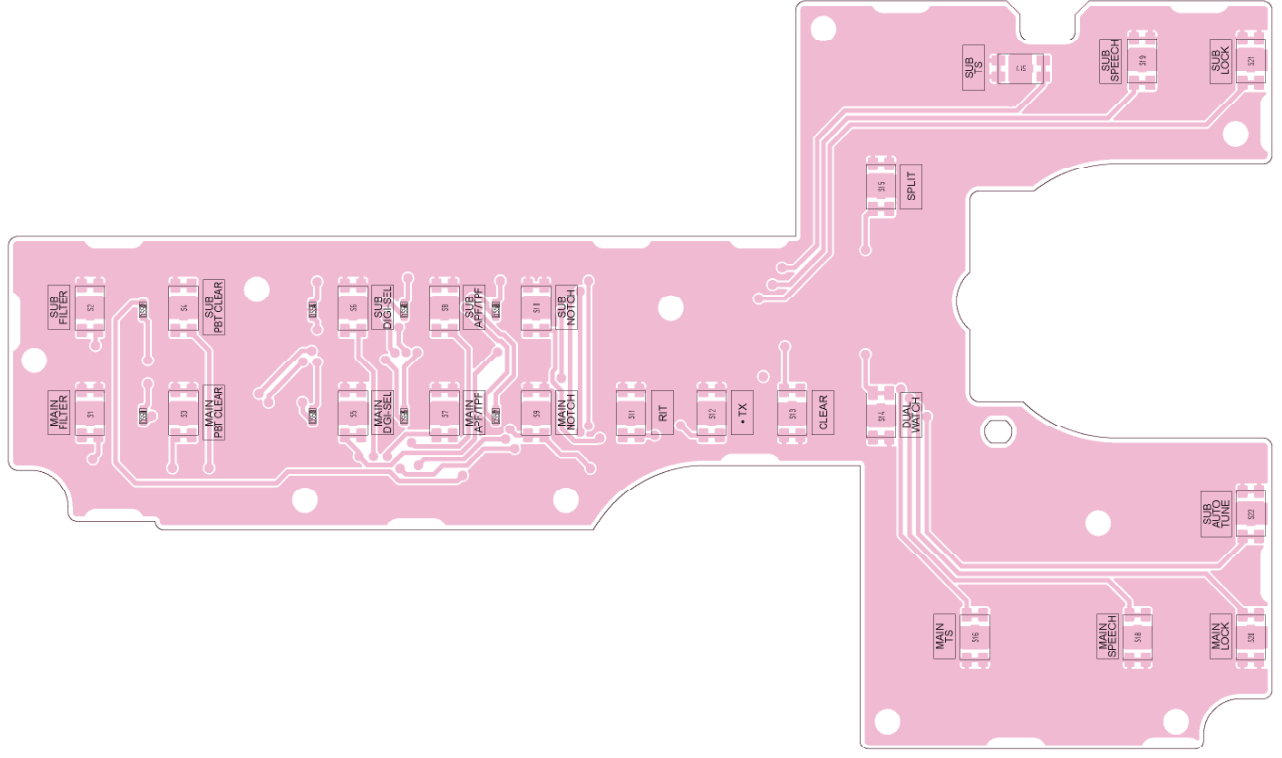

8-3 SW-B BOARD
• TOP VIEW

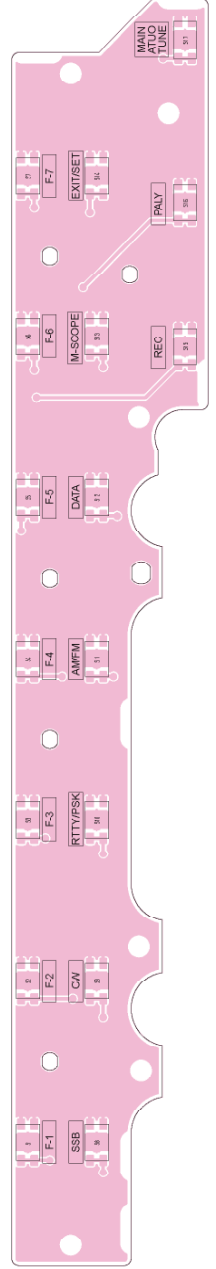

• BOTTOM VIEW (SW-C BOARD)

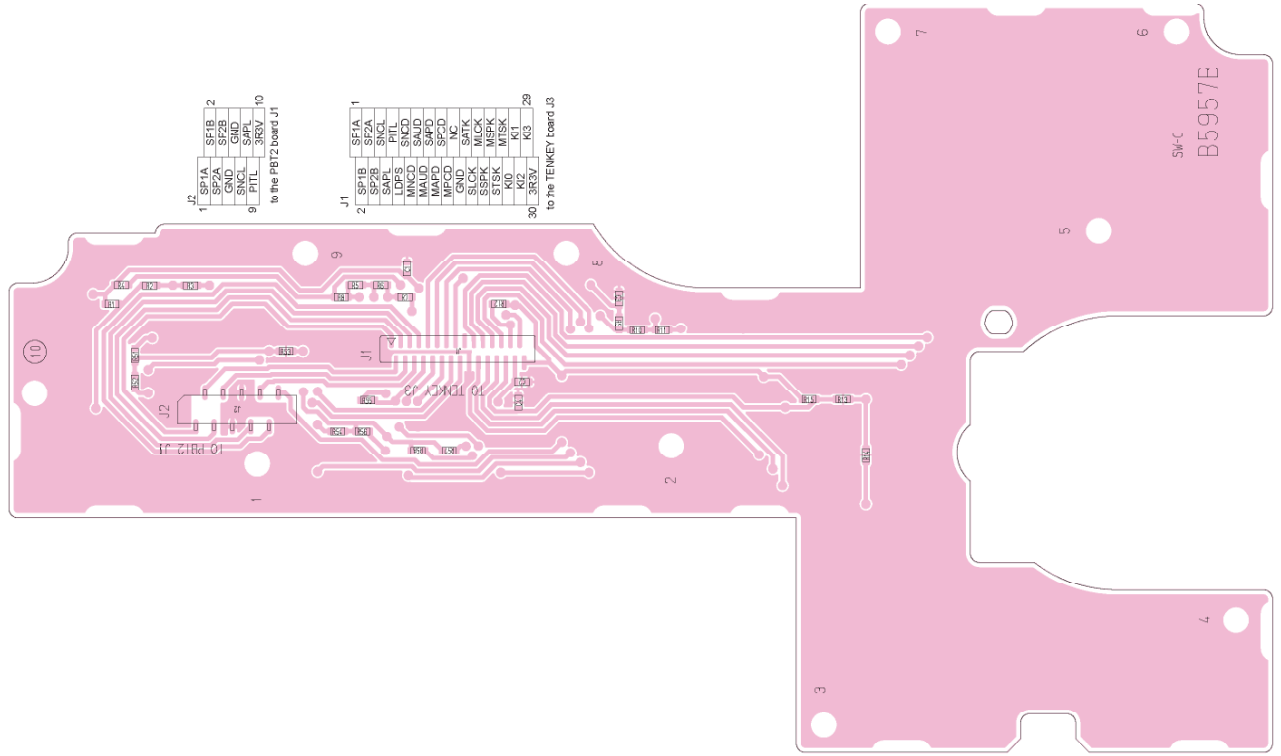

• BOTTOM VIEW (SW-A BOARD)

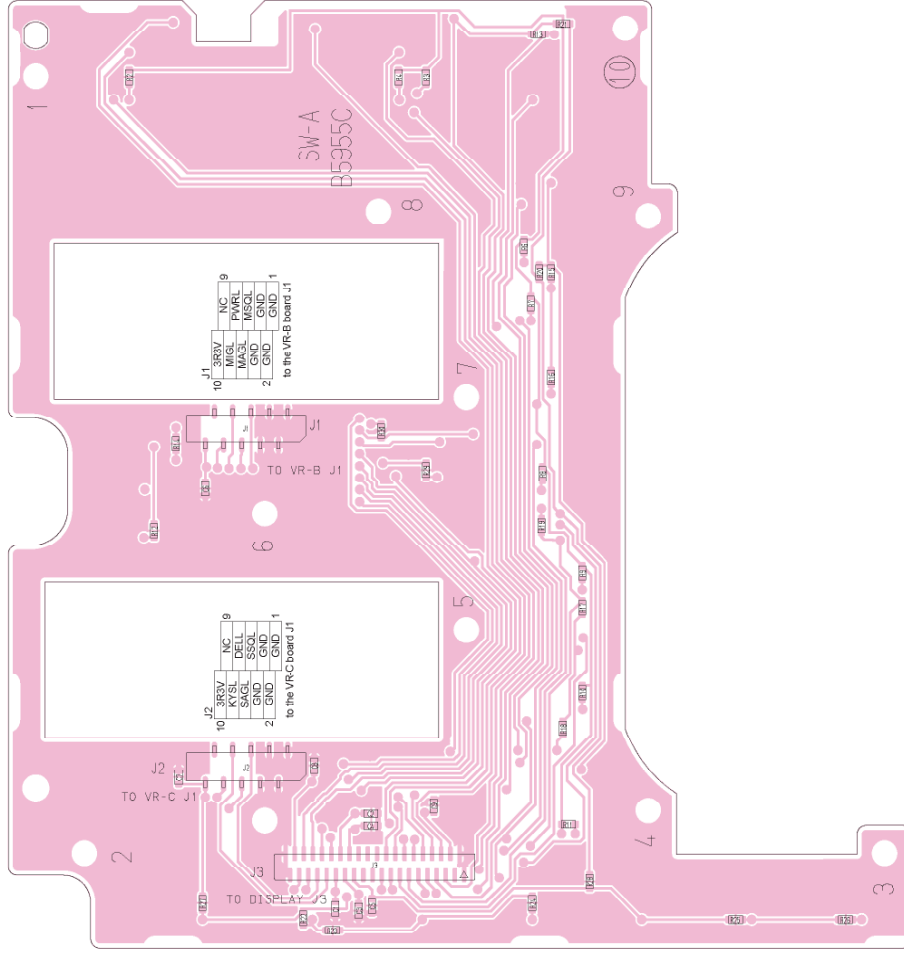

• BOTTOM VIEW (SW-C BOARD)

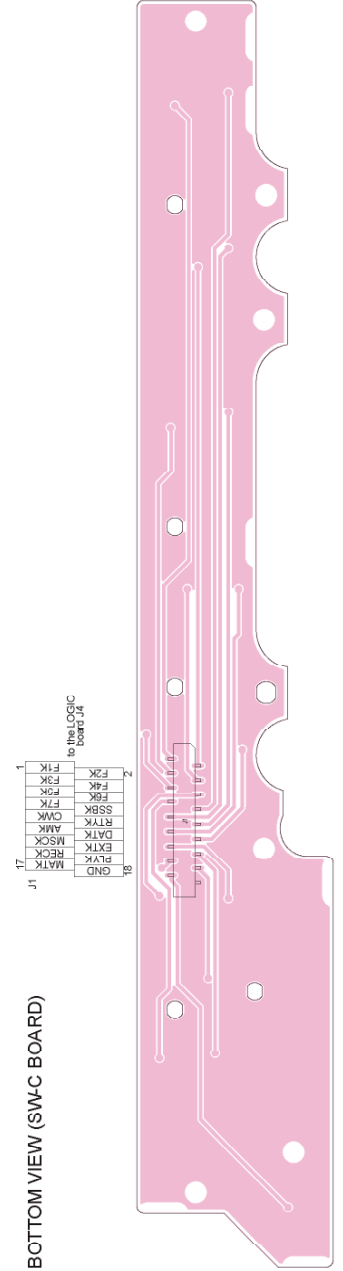

8-5 VR-A BOARD
• TOP VIEW

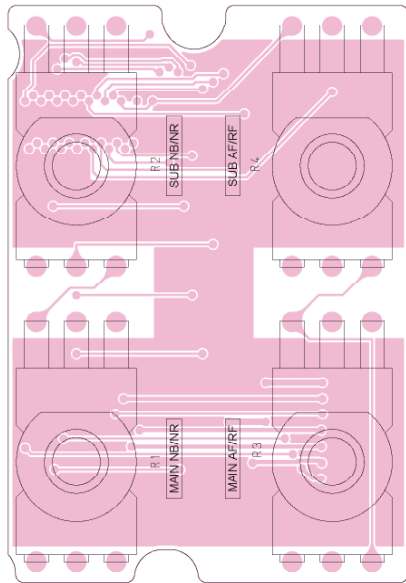

8-6 VR-B BOARD
• TOP VIEW

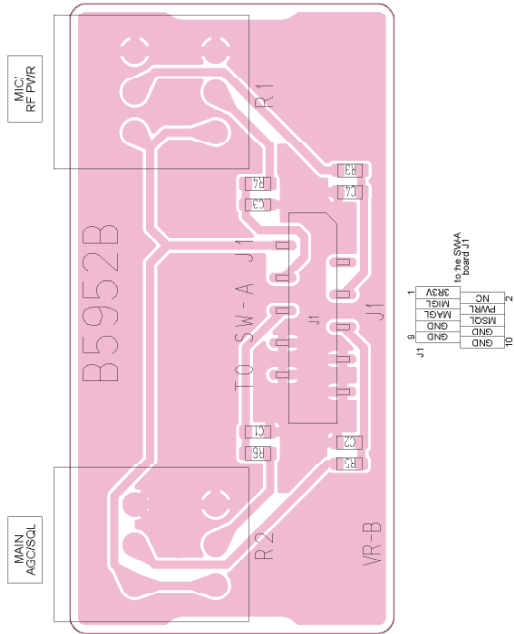

8-7 VR-C BOARD
• TOP VIEW

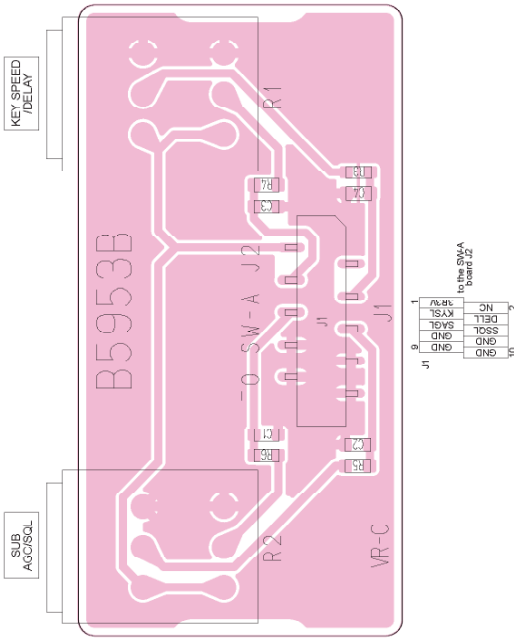

8-8 VR-D BOARD
• TOP VIEW

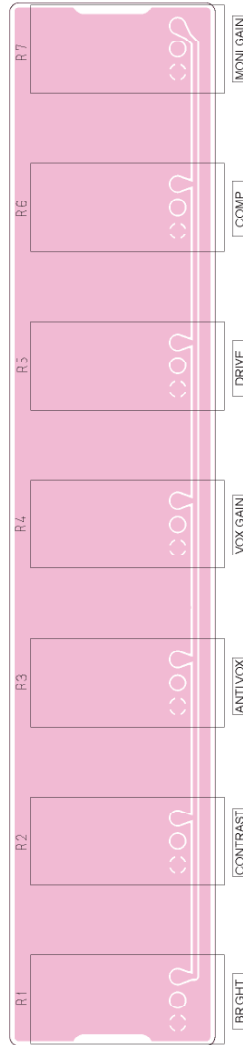

8-9 JACK BOARD
• TOP VIEW

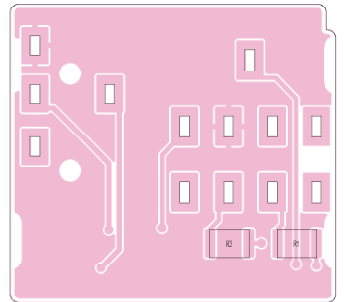

8-10 MIC BOARD
• TOP VIEW

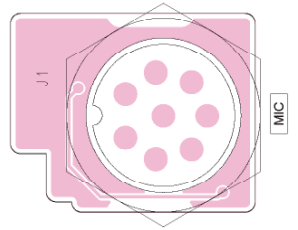

8-11 CF BOARD
• TOP VIEW

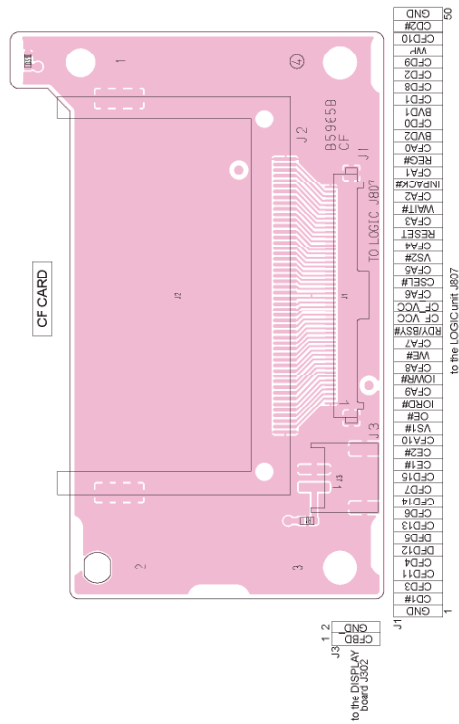

• BOTTOM VIEW (VR-C BOARD)

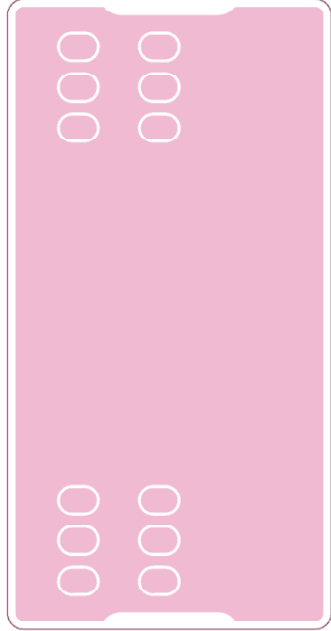

• BOTTOM VIEW (VR-B BOARD)

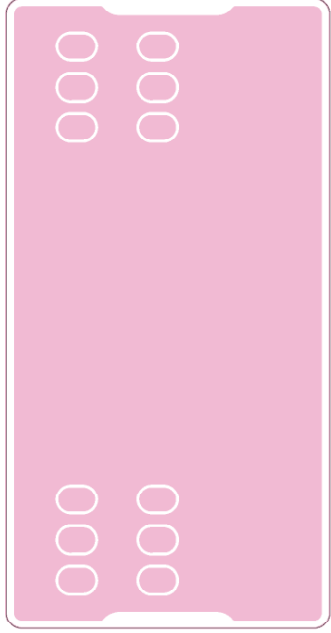

• BOTTOM VIEW (VR-A BOARD)

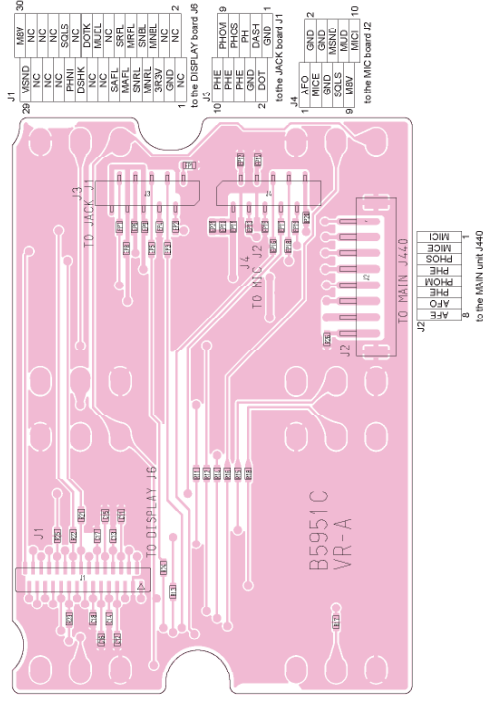

• BOTTOM VIEW (VR-D BOARD)

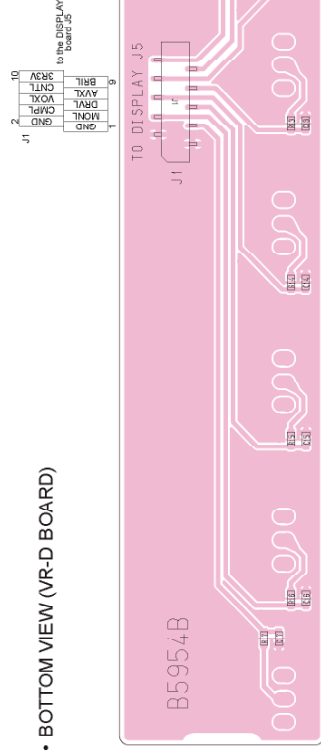

• BOTTOM VIEW (CF BOARD)

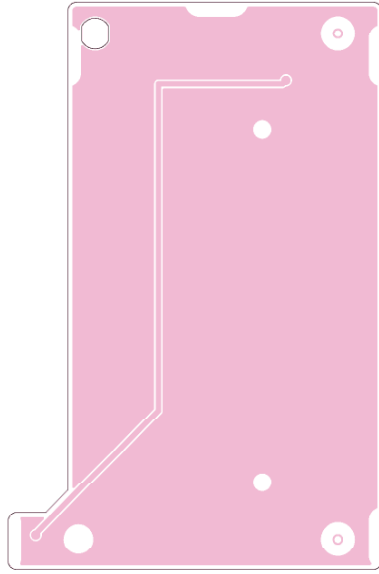

• BOTTOM VIEW (MIC BOARD)

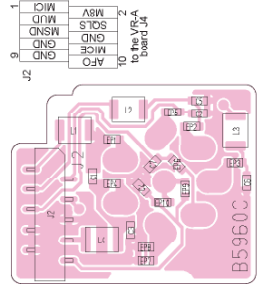

• BOTTOM VIEW (JACK BOARD)

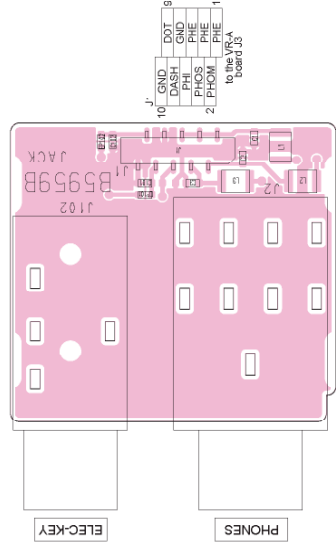

8-12 TENKEY BOARD
• TOP VIEW

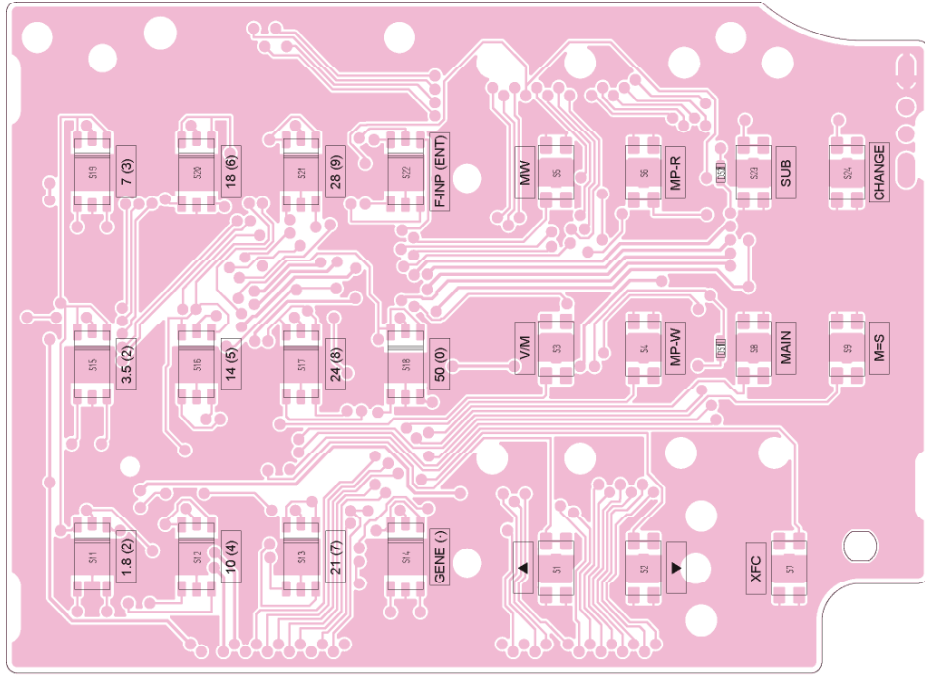

8-14 PBT1 BOARD
• TOP VIEW

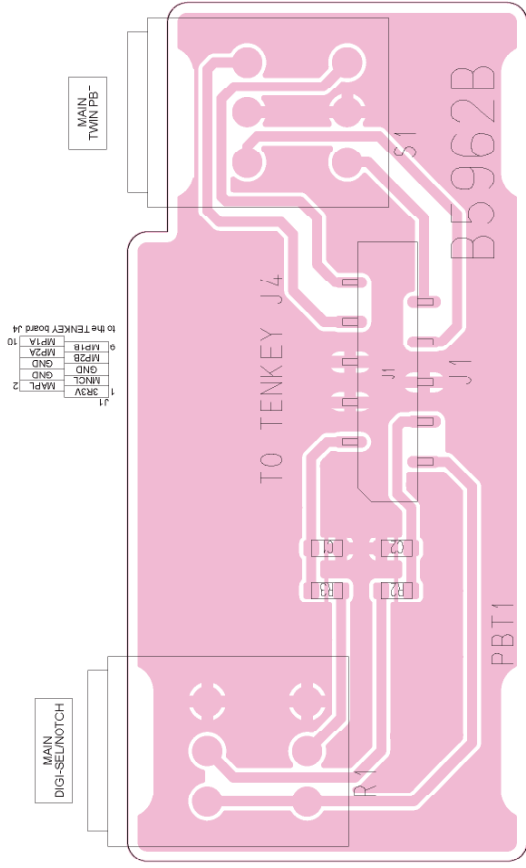

8-15 PBT2 BOARD
• TOP VIEW

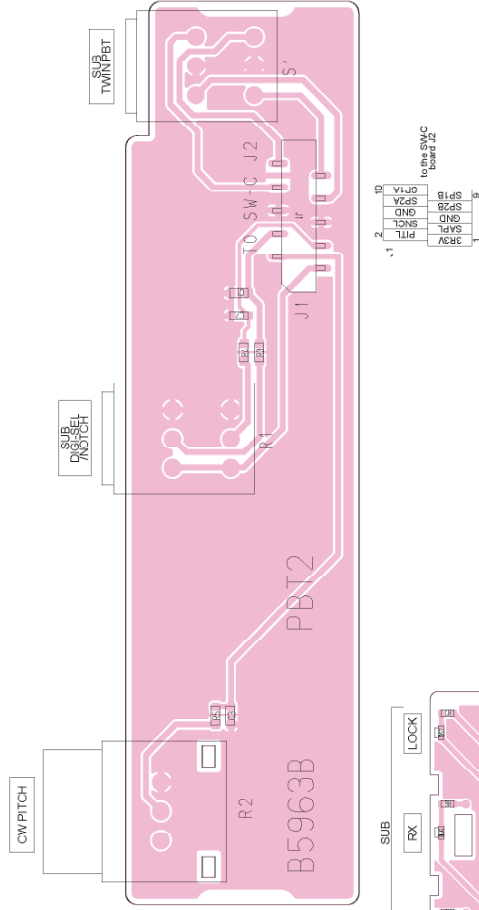

8-13 LED BOARD
• TOP VIEW

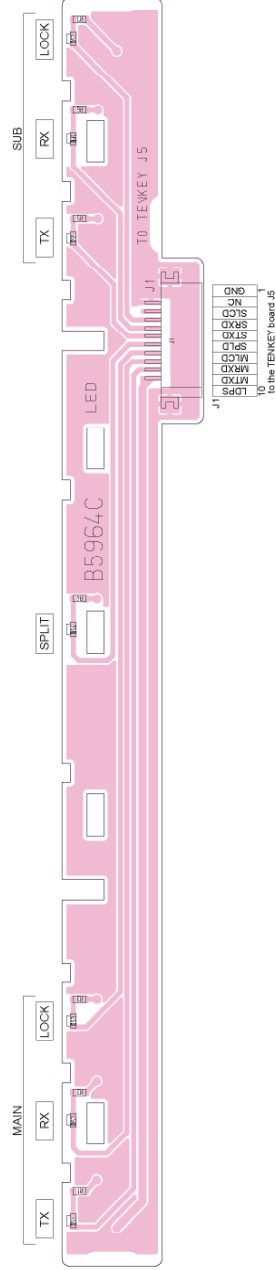

• BOTTOM VIEW (LOGIC UNIT)

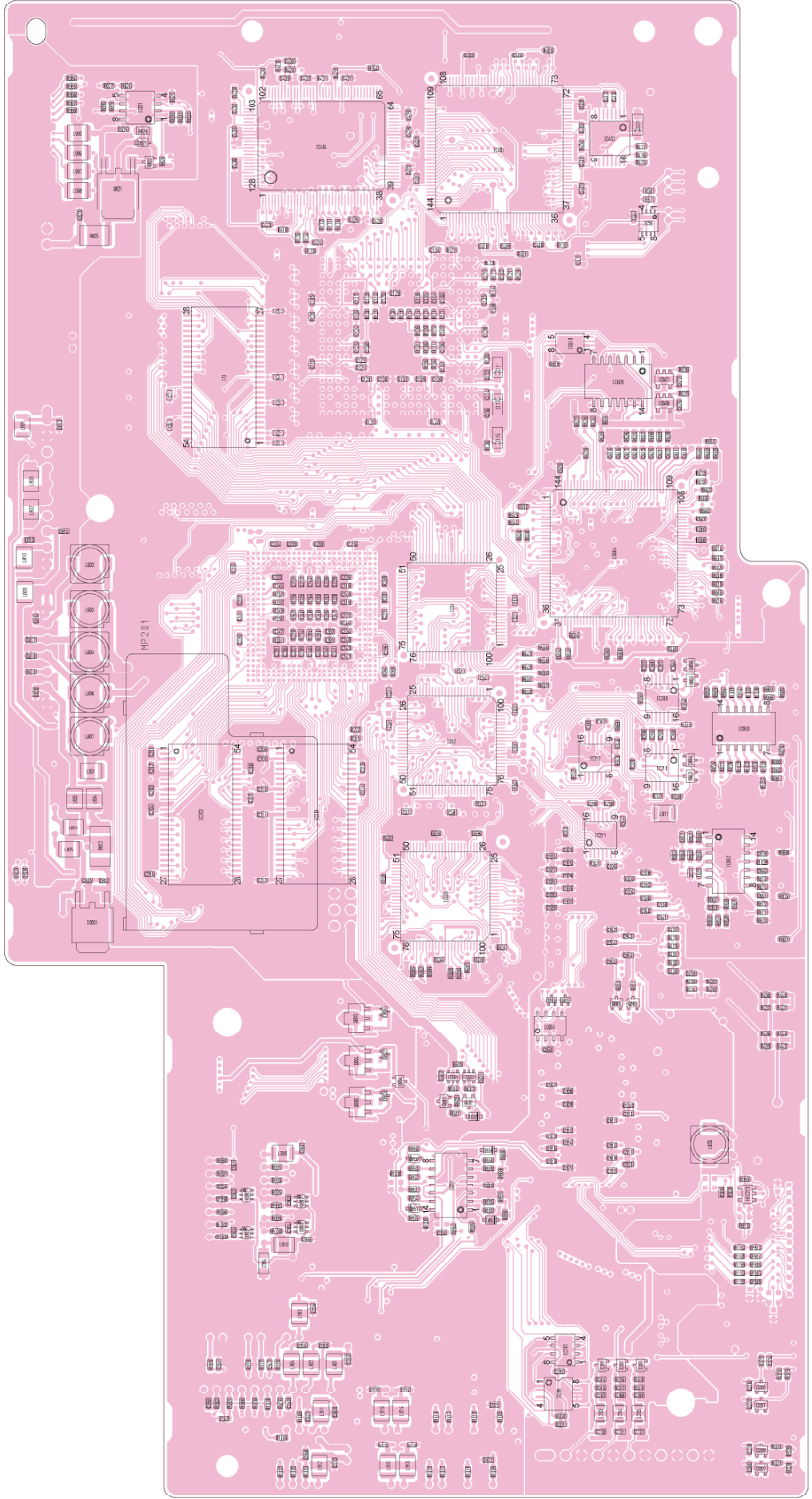

8-17 MEMORY BOARD

• TOP VIEW

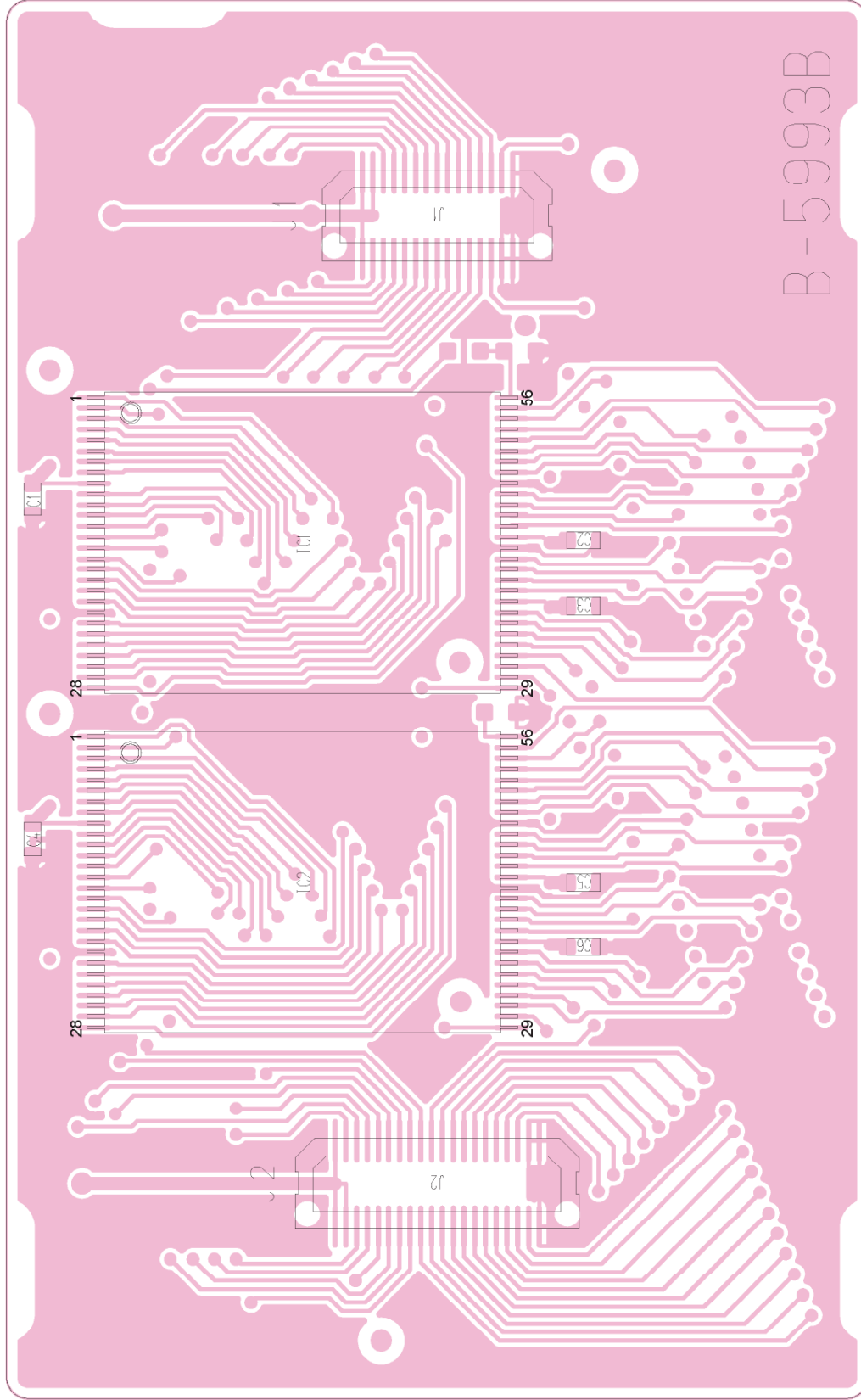

1	+3R3V	+3R3V	40
J2	CE01	+3R3V	
	CE00	CE11	
	CE02	CE10	
	CE21	CE12	
	CE20	CE31	
	CE22	CE30	
	VPEN	CE32	
	RF#	WE#	
	OE#	STS	
	D15	D7	
	D14	D6	
	D13	D5	
	D12	D4	
	D11	D3	
	D10	D2	
	D9	D1	
	D8	D0	
20	GND	BYTE#	21
	GND	GND	

to the LOGIC unit J2

1	+3R3V	+3R3V	30
J1	+3R3V	A22	
	A21	A20	
	A19	A18	
	A17	A16	
	A15	A14	
	A13	A12	
	A11	A10	
	A9	A8	
	A7	A6	
	A5	A4	
	A3	A2	
	A1	A0	
	A23	GND	
15	GND	GND	16

to the LOGIC unit J1

B-5993B

• BOTTOM VIEW (MEMORY BOARD)

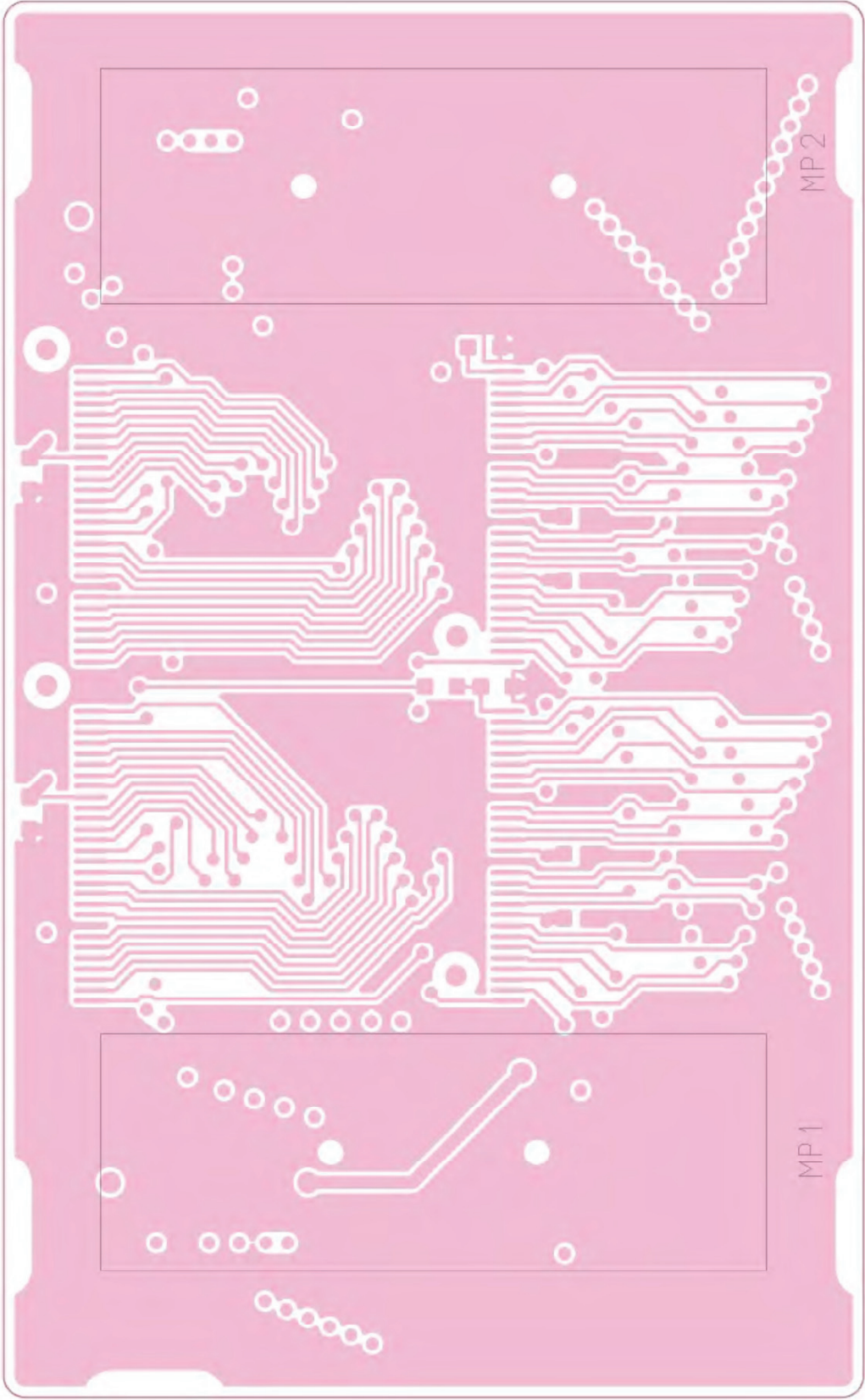

8-18 MAIN UNIT

• TOP VIEW

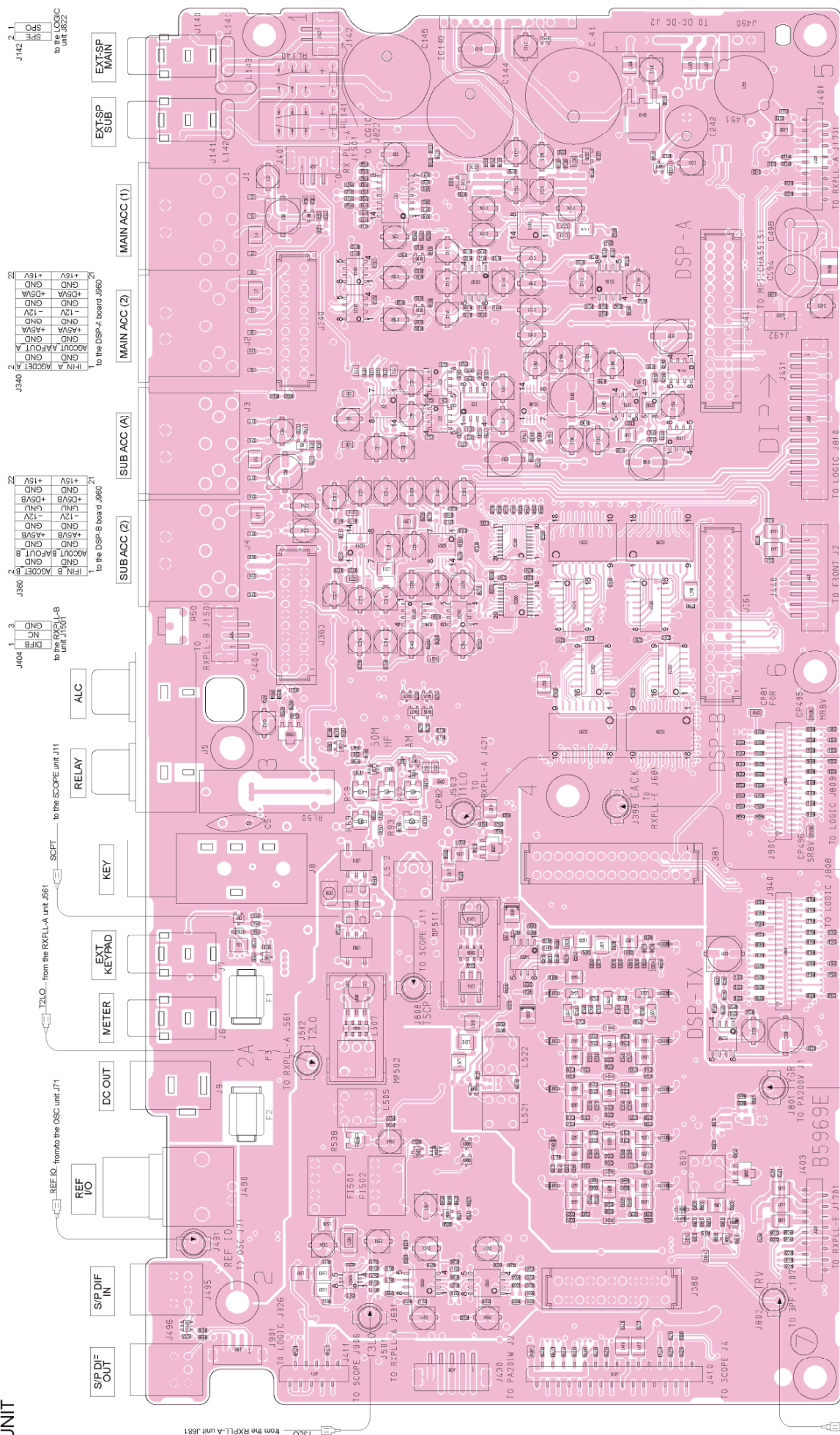

to the BPF unit J107 TRV-TX

J403 1
to the PAC200W board J1

J403 2
to the RXPLL-E J1701

J403 15
to the RXPLL-E J1701

J400 1
to the PAC200W board J1

J400 2
to the RXPLL-E J1701

J380 1
to the RXPLL-B unit J581

J380 2
to the RXPLL-B unit J581

J340 1
to the RXPLL-A unit J421

J340 2
to the RXPLL-A unit J421

J300 1
to the RXPLL-A unit J561

J300 2
to the RXPLL-A unit J561

J260 1
to the RXPLL-A unit J561

J260 2
to the RXPLL-A unit J561

J220 1
to the RXPLL-A unit J561

J220 2
to the RXPLL-A unit J561

J180 1
to the RXPLL-A unit J561

J180 2
to the RXPLL-A unit J561

J140 1
to the RXPLL-A unit J561

J140 2
to the RXPLL-A unit J561

J361
to the scope unit J351

J341
to the RXPLL-E J1701

J321
to the RXPLL-E J1701

J301
to the RXPLL-E J1701

J281
to the RXPLL-E J1701

J261
to the RXPLL-E J1701

J241
to the RXPLL-E J1701

J221
to the RXPLL-E J1701

J201
to the RXPLL-E J1701

J181
to the RXPLL-E J1701

J161
to the RXPLL-E J1701

J141
to the RXPLL-E J1701

J121
to the RXPLL-E J1701

J101
to the RXPLL-E J1701

J81
to the RXPLL-E J1701

J61
to the RXPLL-E J1701

J450 1
to the LOGIC unit J822

J450 2
to the LOGIC unit J822

J430 1
to the DSP-A board J601

J430 2
to the DSP-A board J601

J410 1
to the DSP-A board J601

J410 2
to the DSP-A board J601

J390 1
to the DSP-A board J601

J390 2
to the DSP-A board J601

J370 1
to the DSP-A board J601

J370 2
to the DSP-A board J601

J350 1
to the DSP-A board J601

J350 2
to the DSP-A board J601

J330 1
to the DSP-A board J601

J330 2
to the DSP-A board J601

J310 1
to the DSP-A board J601

J310 2
to the DSP-A board J601

J290 1
to the DSP-A board J601

J290 2
to the DSP-A board J601

J270 1
to the DSP-A board J601

J270 2
to the DSP-A board J601

J250 1
to the DSP-A board J601

J250 2
to the DSP-A board J601

J230 1
to the DSP-A board J601

J230 2
to the DSP-A board J601

J210 1
to the DSP-A board J601

J210 2
to the DSP-A board J601

J190 1
to the DSP-A board J601

J190 2
to the DSP-A board J601

J170 1
to the DSP-A board J601

J170 2
to the DSP-A board J601

J150 1
to the DSP-A board J601

J150 2
to the DSP-A board J601

• BOTTOM VIEW (MAIN UNIT)

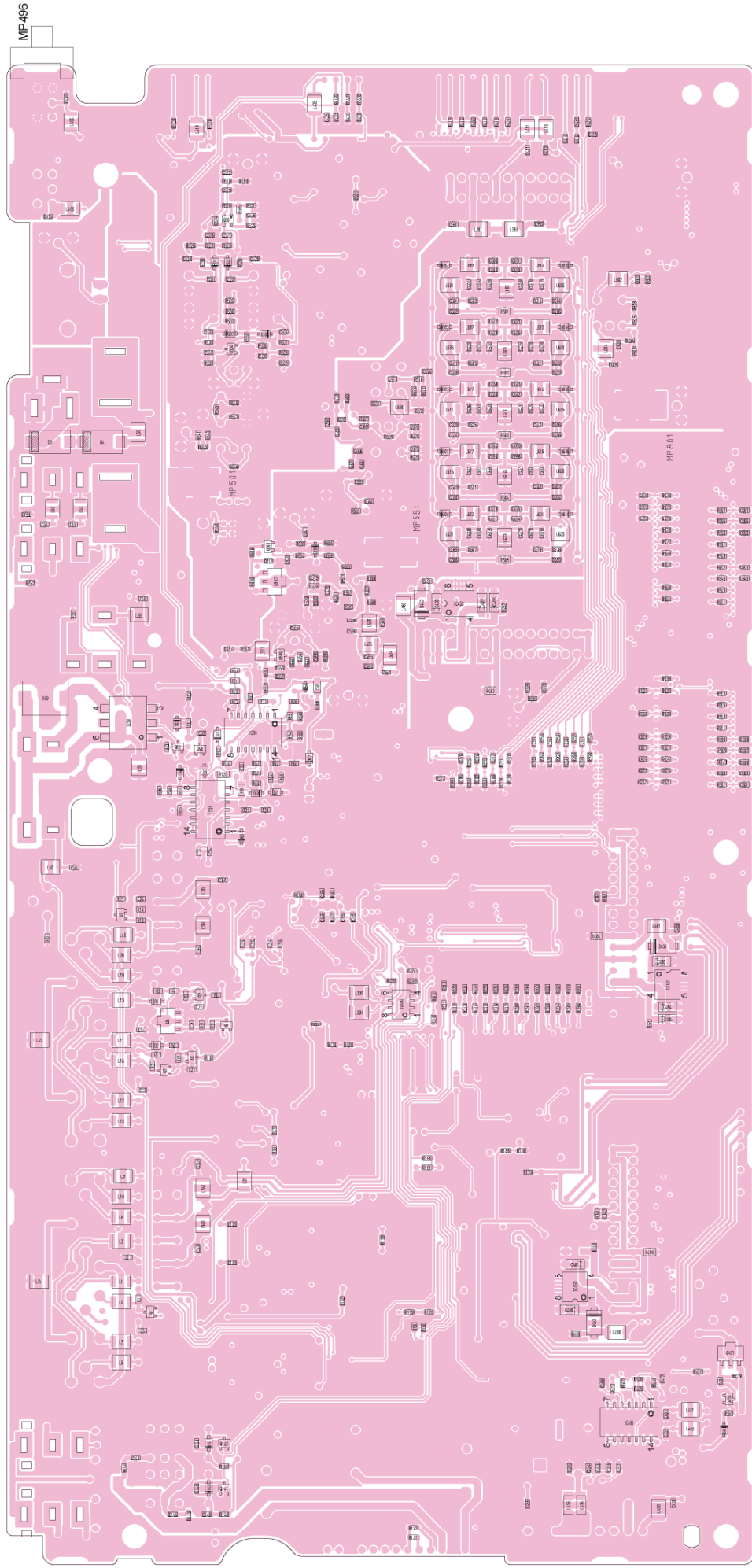

8-19 DSP-A/DSP-B BOARDS
 • TOP VIEW

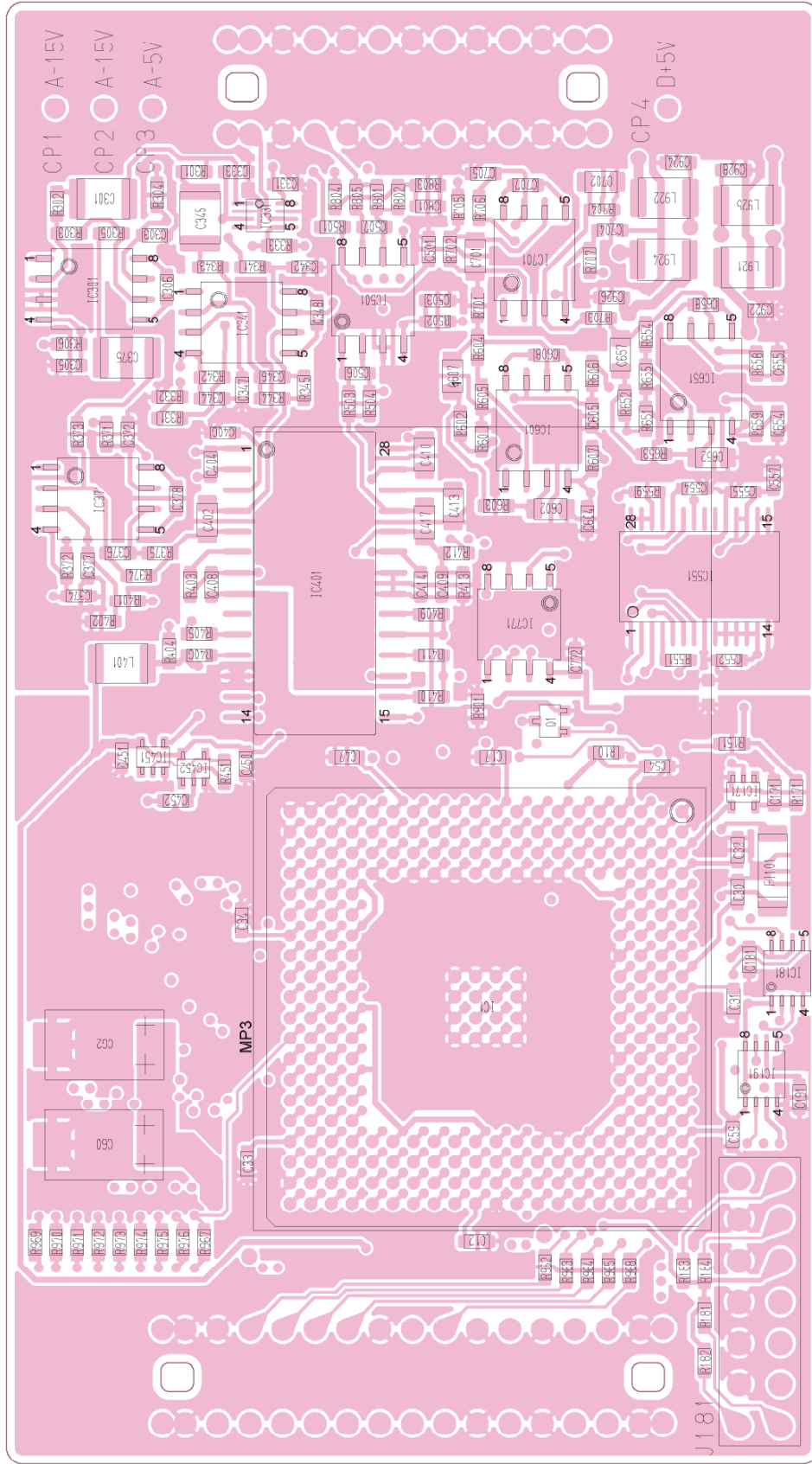

• BOTTOM VIEW (DSP-A/DSP-B BOARDS)

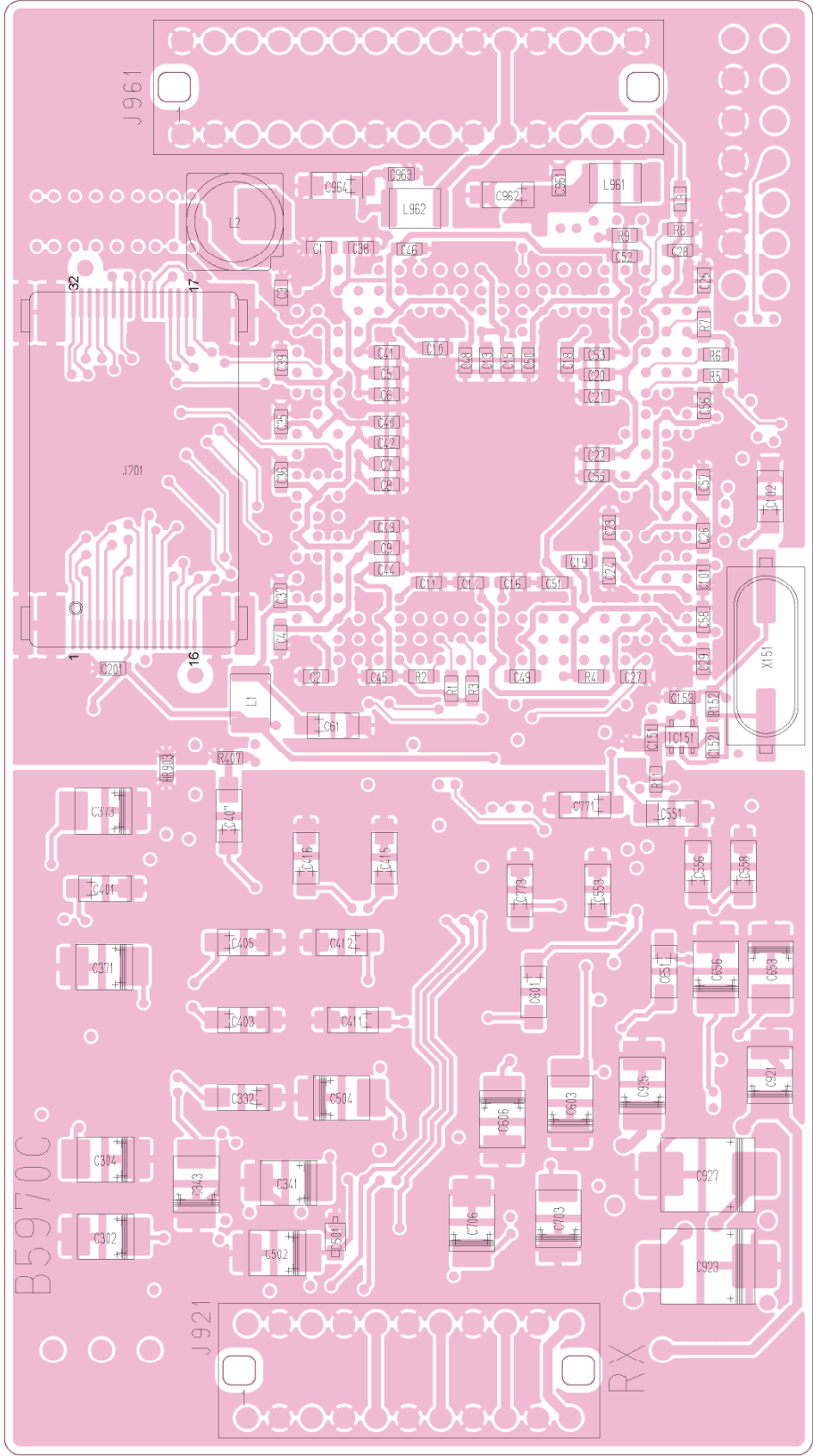

J921

1	AGCDET_A/B	IFIN_A/B	2
	GND	GND	
	AFOJ_T_A/B	AGCOUT_A/B	
	GND	GND	
	+ARV/A/B	+ASV/A/B	
	GND	GND	
	-12V	-12V	
	GND	GND	
	+DSV/A/B	+DSV/A/B	
	GND	GND	
	+15V	+15V	22

to the MAIN unit J340 (DSP-A)
to the MAIN unit J360 (DSP-B)

J961

	GND1A/B	GND1A/B	2
	GND1A/B	MCLK	
	DRES	DSPCK	
	RTDA/B	DSFR	
	NSQLA/B	DFRAB	
	DULSA/B	VSOA/B	
	GND1A/B	DSPCK	
	TNDA/B	DXA/B	
	FRWT	DFX/A/B	
	GND1A/B	GND1A/B	
	D9P3V	D3R3V	
	GND1A/B	GND1A/B	
	DIRV_396V_A/B	DIR2V_A/B	
	DIRV_396V_B	DIR2V_B	

23 GND1A/B GND1A/B 30
to the MAIN unit J341 (DSP-A)
to the MAIN unit J361 (DSP-B)

8-20 DSP-TX BOARD
 • TOP VIEW

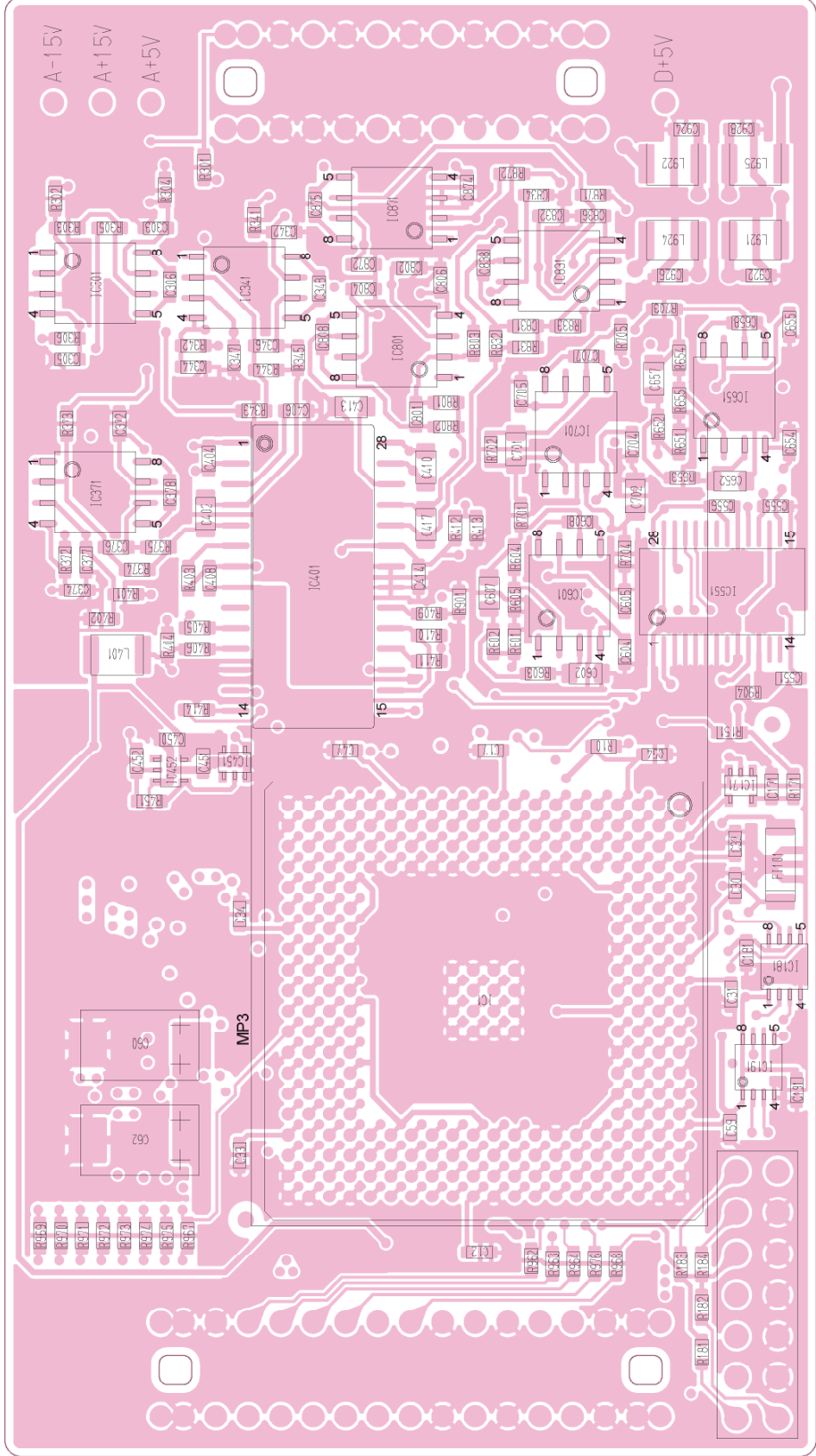

• BOTTOM VIEW (DSP-TX BOARD)

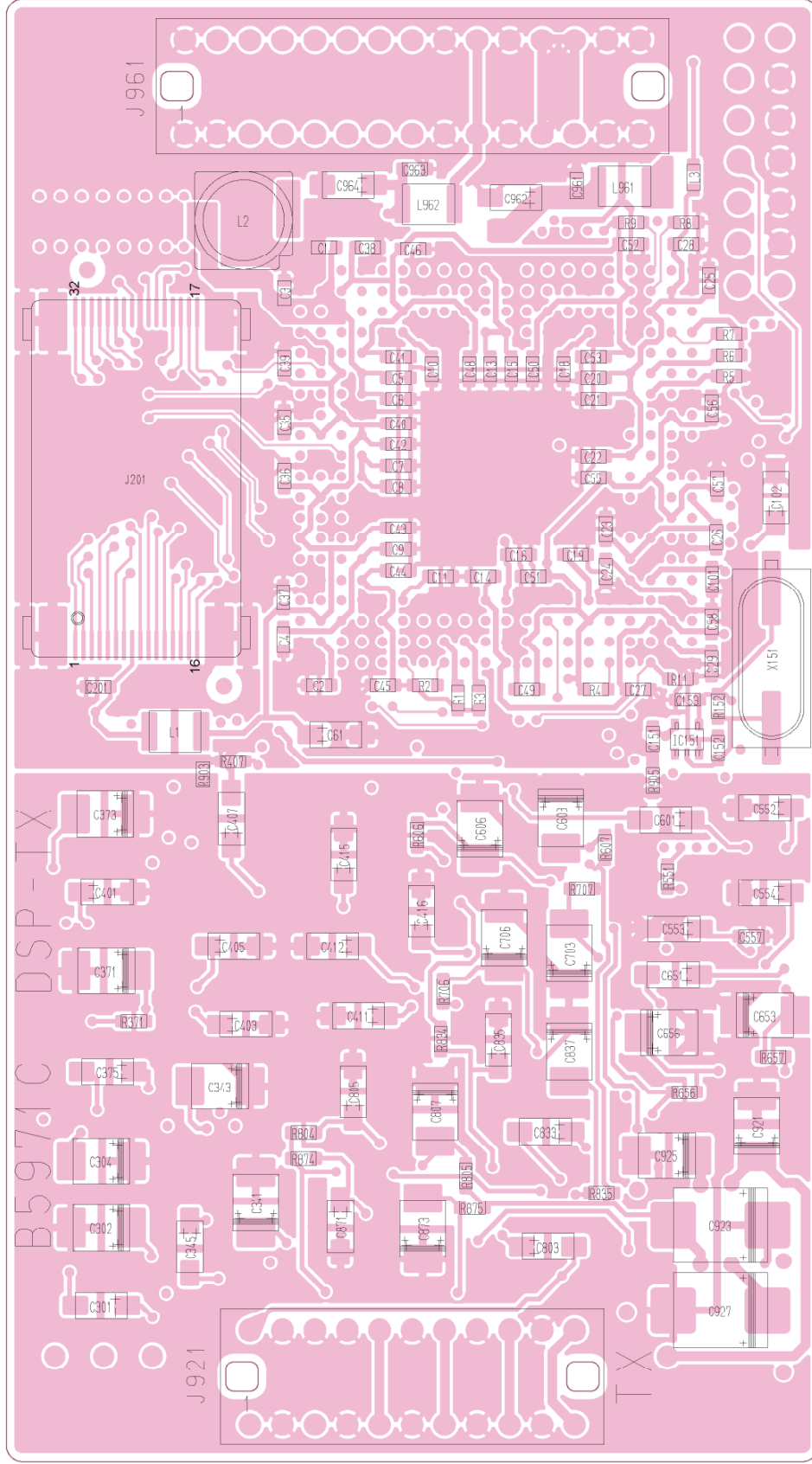

1	J921	AFIN	ANVOX	2
		GND	GND	
		TX36K	GND	
		GND	GND	
		+A5VT	+A5VT	
		-12V	-12V	
		GND	GND	
		+D5VT	+D5VT	
		GND	GND	
		+15V	+15V	22
				to the MAIN unit J380

1	J961	GND1T	GND1T	2
		DRES	DSPCK	
		D3KY	DSPR	
		CIFL	DFRT	
		DAVOX	DSPCK	
		CVOX	DXIT	
		FRWT	DFXT	
		D3R3V	GND1T	
		GND1T	GND1T	
		D1R2V_T	D1R2V_T	
		D1R3_36K_T	D1R2V_T	
		GND1T	GND1T	30
		GND1T	GND1T	to the MAIN unit J881

8-21 SCOPE UNIT
• TOP VIEW

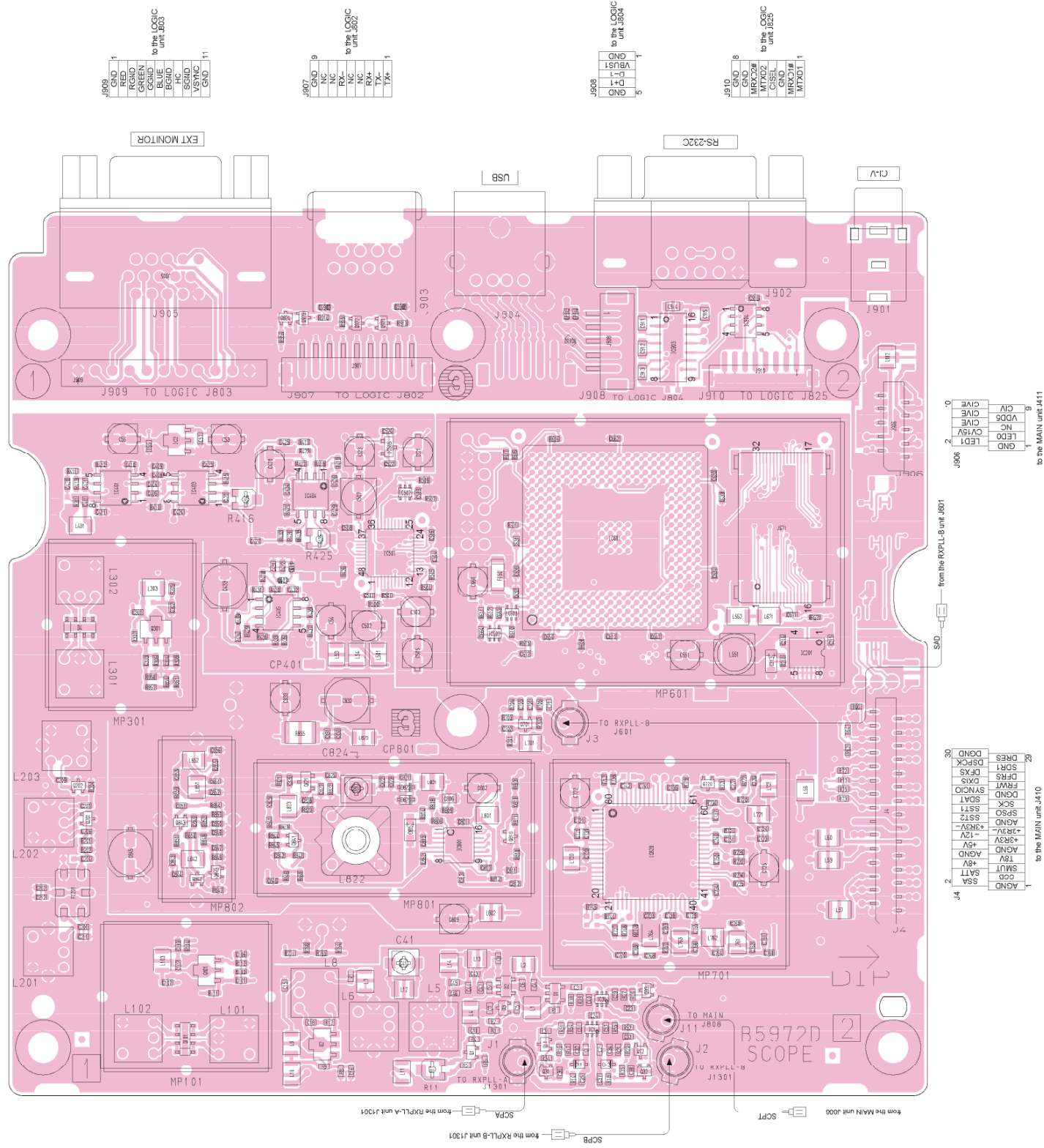

• BOTTOM VIEW (SCOPE UNIT)

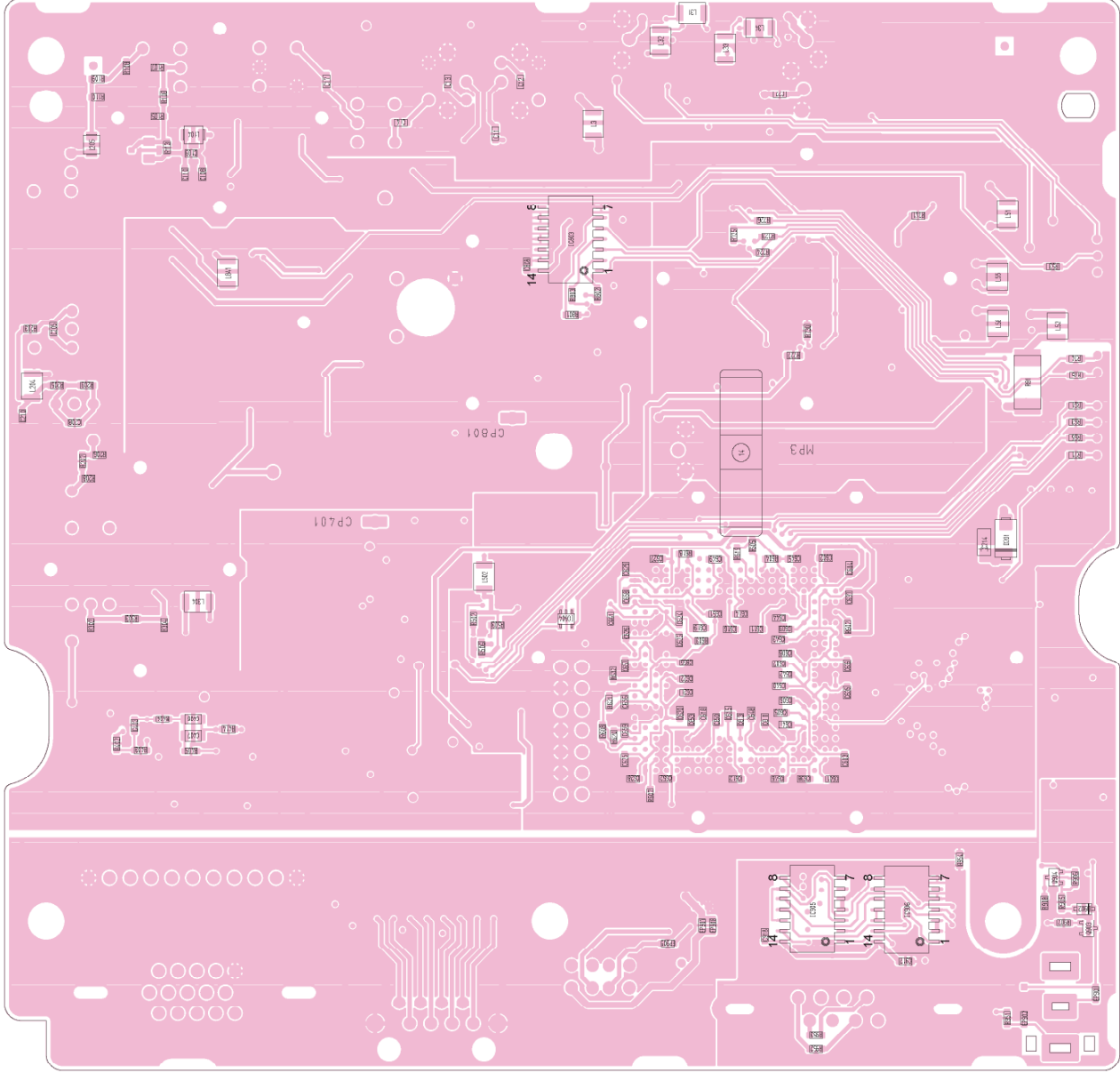

8-22 RXPLL-A UNIT • TOP VIEW

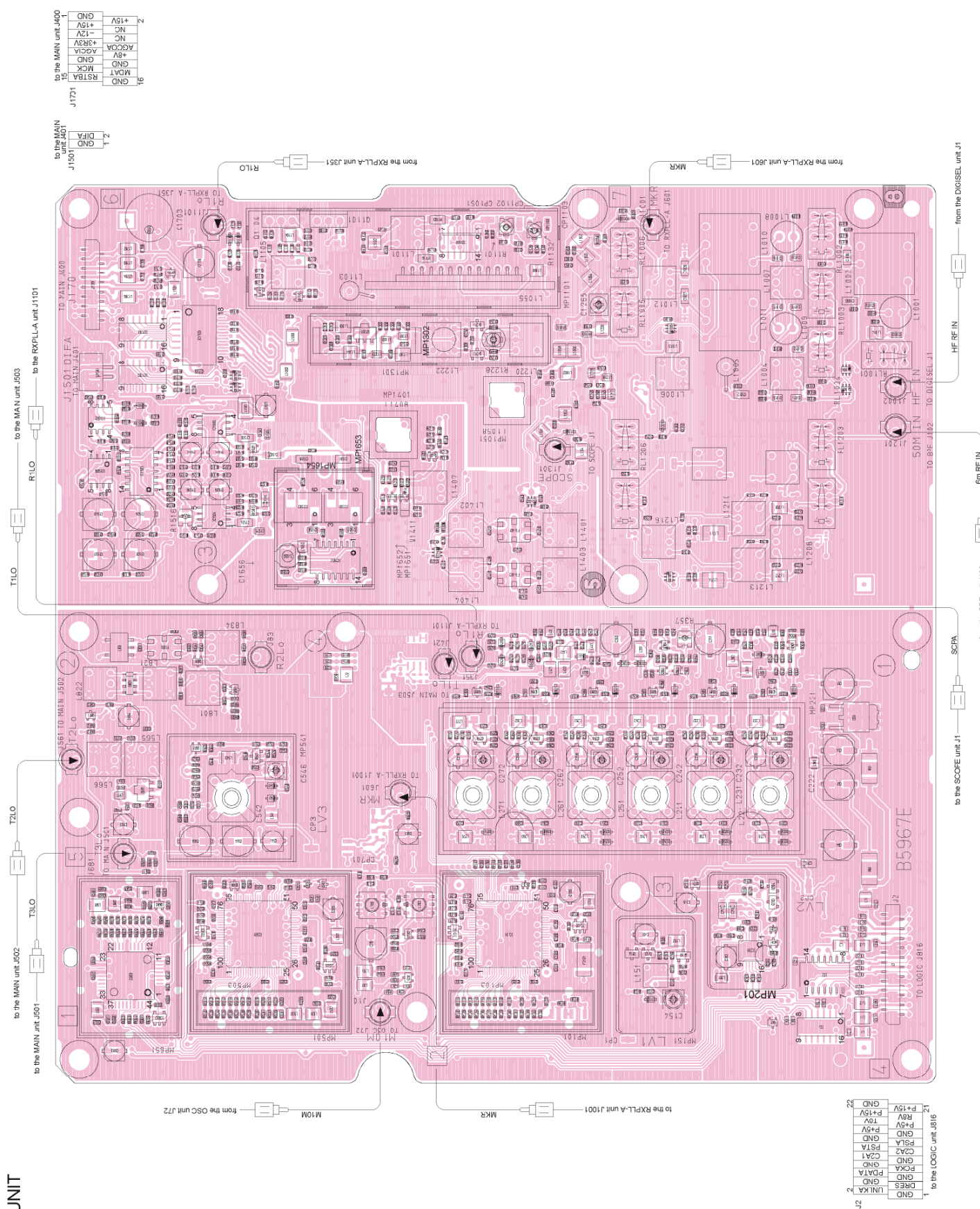

1	GND
2	UNIKA
3	DRESS
4	GND
5	PDATA
6	GND
7	PCKA
8	GND
9	C2A1
10	GND
11	C2A2
12	GND
13	PSIA
14	GND
15	PSA
16	GND
17	P+5V
18	R8V
19	P+15V
20	GND

1	GND
2	UNIKA
3	DRESS
4	GND
5	PDATA
6	GND
7	PCKA
8	GND
9	C2A1
10	GND
11	C2A2
12	GND
13	PSIA
14	GND
15	PSA
16	GND
17	P+5V
18	R8V
19	P+15V
20	GND

1	GND
2	UNIKA
3	DRESS
4	GND
5	PDATA
6	GND
7	PCKA
8	GND
9	C2A1
10	GND
11	C2A2
12	GND
13	PSIA
14	GND
15	PSA
16	GND
17	P+5V
18	R8V
19	P+15V
20	GND

1	GND
2	UNIKA
3	DRESS
4	GND
5	PDATA
6	GND
7	PCKA
8	GND
9	C2A1
10	GND
11	C2A2
12	GND
13	PSIA
14	GND
15	PSA
16	GND
17	P+5V
18	R8V
19	P+15V
20	GND

1	GND
2	UNIKA
3	DRESS
4	GND
5	PDATA
6	GND
7	PCKA
8	GND
9	C2A1
10	GND
11	C2A2
12	GND
13	PSIA
14	GND
15	PSA
16	GND
17	P+5V
18	R8V
19	P+15V
20	GND

1	GND
2	UNIKA
3	DRESS
4	GND
5	PDATA
6	GND
7	PCKA
8	GND
9	C2A1
10	GND
11	C2A2
12	GND
13	PSIA
14	GND
15	PSA
16	GND
17	P+5V
18	R8V
19	P+15V
20	GND

1	GND
2	UNIKA
3	DRESS
4	GND
5	PDATA
6	GND
7	PCKA
8	GND
9	C2A1
10	GND
11	C2A2
12	GND
13	PSIA
14	GND
15	PSA
16	GND
17	P+5V
18	R8V
19	P+15V
20	GND

1	GND
2	UNIKA
3	DRESS
4	GND
5	PDATA
6	GND
7	PCKA
8	GND
9	C2A1
10	GND
11	C2A2
12	GND
13	PSIA
14	GND
15	PSA
16	GND
17	P+5V
18	R8V
19	P+15V
20	GND

1	GND
2	UNIKA
3	DRESS
4	GND
5	PDATA
6	GND
7	PCKA
8	GND
9	C2A1
10	GND
11	C2A2
12	GND
13	PSIA
14	GND
15	PSA
16	GND
17	P+5V
18	R8V
19	P+15V
20	GND

1	GND
2	UNIKA
3	DRESS
4	GND
5	PDATA
6	GND
7	PCKA
8	GND
9	C2A1
10	GND
11	C2A2
12	GND
13	PSIA
14	GND
15	PSA
16	GND
17	P+5V
18	R8V
19	P+15V
20	GND

1	GND
2	UNIKA
3	DRESS
4	GND
5	PDATA
6	GND
7	PCKA
8	GND
9	C2A1
10	GND
11	C2A2
12	GND
13	PSIA
14	GND
15	PSA
16	GND
17	P+5V
18	R8V
19	P+15V
20	GND

1	GND
2	UNIKA
3	DRESS
4	GND
5	PDATA
6	GND
7	PCKA
8	GND
9	C2A1
10	GND
11	C2A2
12	GND
13	PSIA
14	GND
15	PSA
16	GND
17	P+5V
18	R8V
19	P+15V
20	GND

1	GND
2	UNIKA
3	DRESS
4	GND
5	PDATA
6	GND
7	PCKA
8	GND
9	C2A1
10	GND
11	C2A2
12	GND
13	PSIA
14	GND
15	PSA
16	GND
17	P+5V
18	R8V
19	P+15V
20	GND

• BOTTOM VIEW (RXPLL-A UNIT)

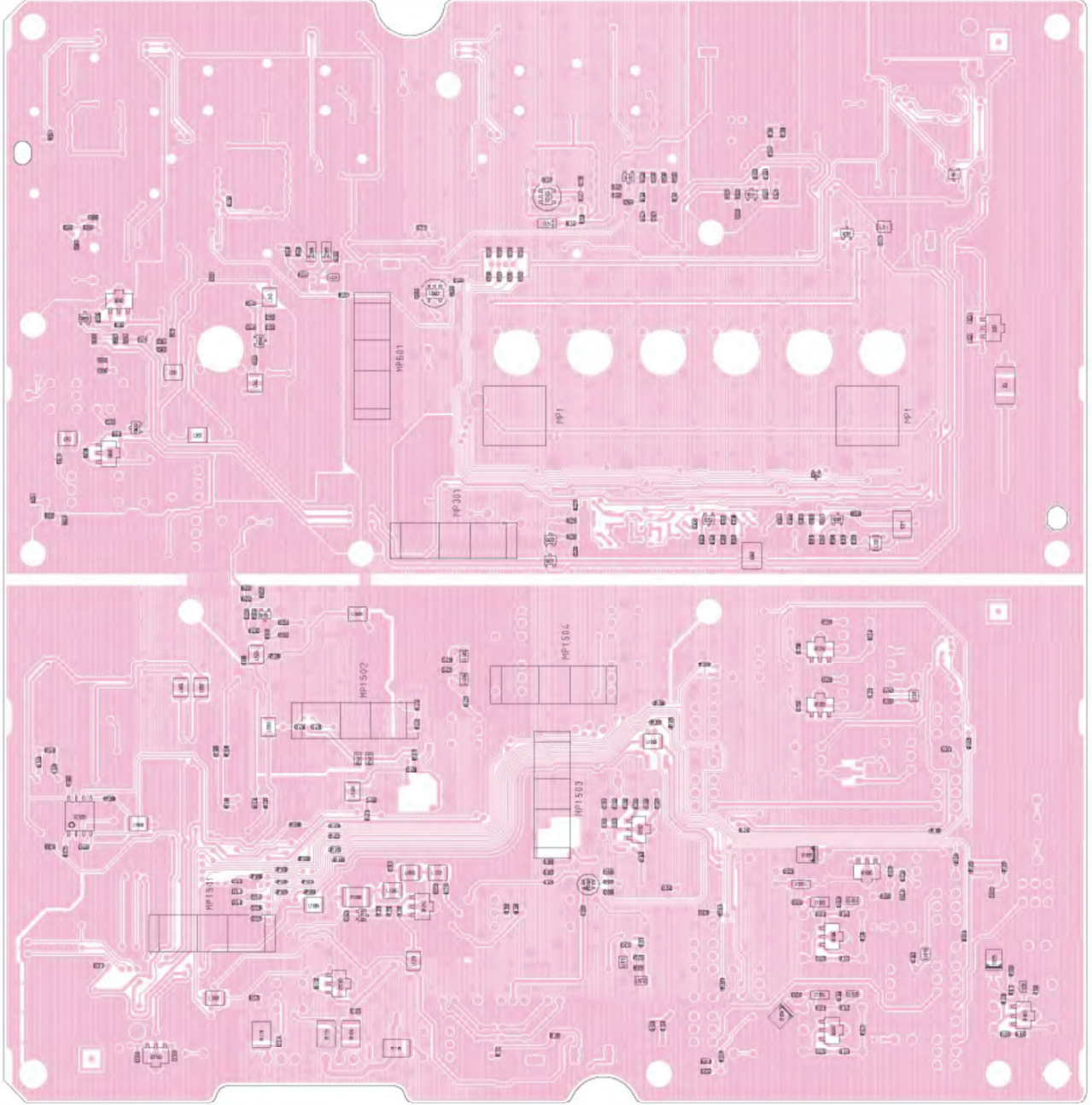

8-23 RXPLL-B UNIT

• TOP VIEW

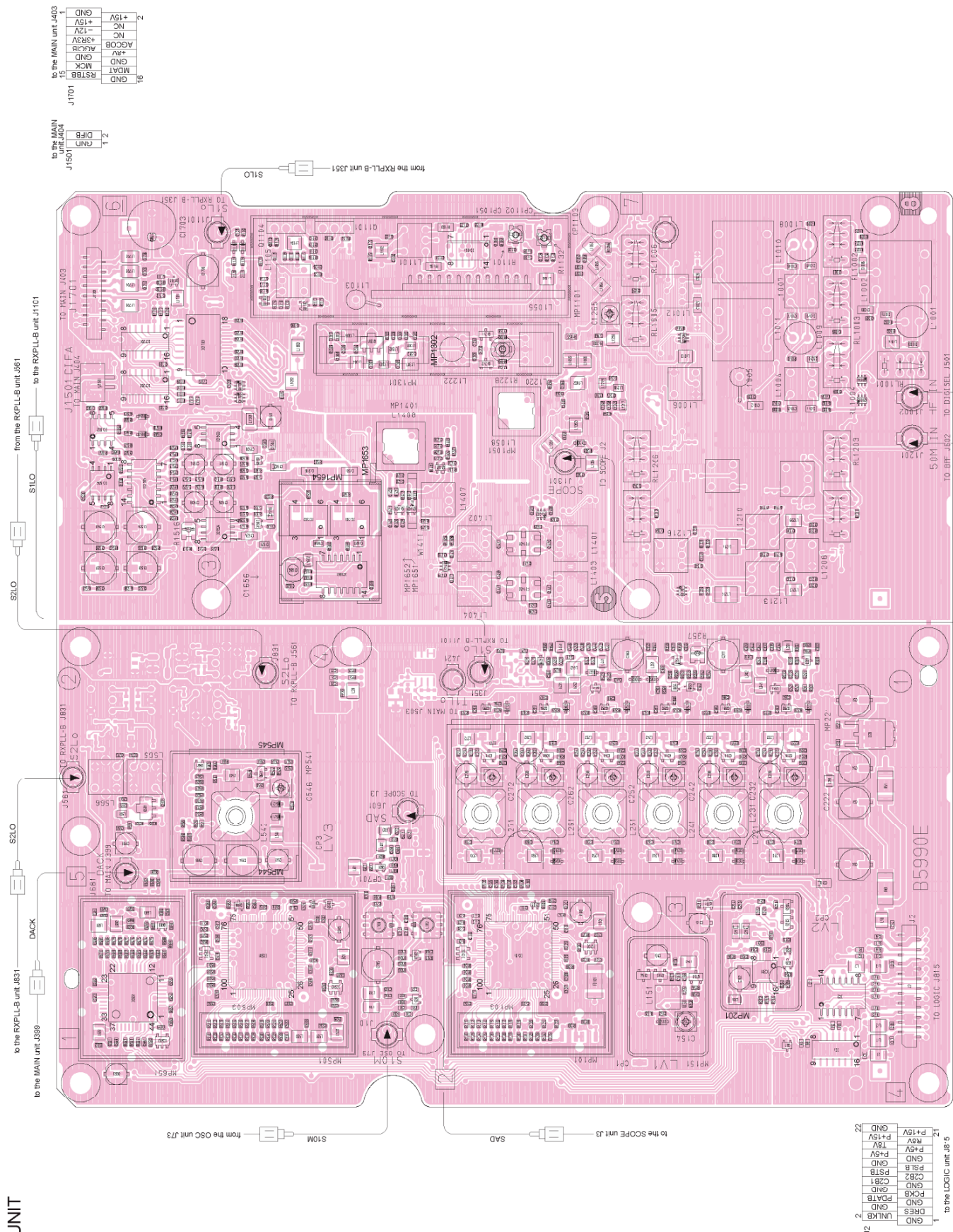

to the LOGIC unit J8 5

12	GND
11	UNLK B
10	GND
9	PMA B
8	PCK B
7	GND
6	GND
5	CZB 1
4	CZB 2
3	GND
2	PS1 B
1	PS2 B
0	GND
15V	P+15V
14	TSV
13	TSV
12	TSV
11	TSV
10	TSV
9	TSV
8	TSV
7	TSV
6	TSV
5	TSV
4	TSV
3	TSV
2	TSV
1	TSV
0	TSV

to the MAIN unit J101

15	GND
14	RST B
13	MDAT
12	GND
11	MCK
10	GND
9	AV
8	ACOB
7	ACOB
6	ACOB
5	ACOB
4	ACOB
3	ACOB
2	ACOB
1	ACOB
0	ACOB

to the MAIN unit J101

to the MAIN unit J104

to the MAIN unit J103

to the MAIN unit J102

to the MAIN unit J101

to the MAIN unit J100

to the MAIN unit J99

to the MAIN unit J98

to the MAIN unit J97

to the MAIN unit J96

to the MAIN unit J95

to the MAIN unit J94

to the MAIN unit J93

to the MAIN unit J92

to the MAIN unit J91

to the MAIN unit J90

to the MAIN unit J89

to the MAIN unit J88

to the MAIN unit J87

to the MAIN unit J86

to the MAIN unit J85

to the MAIN unit J84

to the MAIN unit J83

to the MAIN unit J82

to the MAIN unit J81

to the MAIN unit J80

to the MAIN unit J79

to the MAIN unit J78

to the MAIN unit J77

to the MAIN unit J76

to the MAIN unit J75

to the MAIN unit J74

to the MAIN unit J73

to the MAIN unit J72

to the MAIN unit J71

to the MAIN unit J70

to the MAIN unit J69

to the MAIN unit J68

to the MAIN unit J67

to the MAIN unit J66

to the MAIN unit J65

to the MAIN unit J64

to the MAIN unit J63

to the MAIN unit J62

to the MAIN unit J61

to the MAIN unit J60

to the MAIN unit J59

to the MAIN unit J58

to the MAIN unit J57

to the MAIN unit J56

to the MAIN unit J55

to the MAIN unit J54

to the MAIN unit J53

to the MAIN unit J52

to the MAIN unit J51

to the MAIN unit J50

to the MAIN unit J49

to the MAIN unit J48

to the MAIN unit J47

to the MAIN unit J46

to the MAIN unit J45

to the MAIN unit J44

to the MAIN unit J43

to the MAIN unit J42

to the MAIN unit J41

to the MAIN unit J40

to the MAIN unit J39

to the MAIN unit J38

to the MAIN unit J37

to the MAIN unit J36

to the MAIN unit J35

to the MAIN unit J34

to the MAIN unit J33

to the MAIN unit J32

to the MAIN unit J31

to the MAIN unit J30

to the MAIN unit J29

to the MAIN unit J28

to the MAIN unit J27

to the MAIN unit J26

to the MAIN unit J25

to the MAIN unit J24

to the MAIN unit J23

to the MAIN unit J22

to the MAIN unit J21

to the MAIN unit J20

to the MAIN unit J19

to the MAIN unit J18

to the MAIN unit J17

to the MAIN unit J16

to the MAIN unit J15

to the MAIN unit J14

to the MAIN unit J13

to the MAIN unit J12

to the MAIN unit J11

to the MAIN unit J10

to the MAIN unit J9

to the MAIN unit J8

to the MAIN unit J7

to the MAIN unit J6

to the MAIN unit J5

to the MAIN unit J4

to the MAIN unit J3

to the MAIN unit J2

to the MAIN unit J1

to the MAIN unit J0

to the MAIN unit J-1

to the MAIN unit J-2

to the MAIN unit J-3

to the MAIN unit J-4

to the MAIN unit J-5

to the MAIN unit J-6

to the MAIN unit J-7

to the MAIN unit J-8

to the MAIN unit J-9

to the MAIN unit J-10

to the MAIN unit J-11

to the MAIN unit J-12

to the MAIN unit J-13

to the MAIN unit J-14

to the MAIN unit J-15

to the MAIN unit J-16

to the MAIN unit J-17

to the MAIN unit J-18

to the MAIN unit J-19

to the MAIN unit J-20

to the MAIN unit J-21

to the MAIN unit J-22

to the MAIN unit J-23

to the MAIN unit J-24

to the MAIN unit J-25

to the MAIN unit J-26

to the MAIN unit J-27

to the MAIN unit J-28

to the MAIN unit J-29

to the MAIN unit J-30

to the MAIN unit J-31

to the MAIN unit J-32

to the MAIN unit J-33

to the MAIN unit J-34

to the MAIN unit J-35

to the MAIN unit J-36

to the MAIN unit J-37

to the MAIN unit J-38

to the MAIN unit J-39

to the MAIN unit J-40

to the MAIN unit J-41

to the MAIN unit J-42

to the MAIN unit J-43

to the MAIN unit J-44

to the MAIN unit J-45

to the MAIN unit J-46

to the MAIN unit J-47

to the MAIN unit J-48

to the MAIN unit J-49

to the MAIN unit J-50

to the MAIN unit J-51

to the MAIN unit J-52

to the MAIN unit J-53

to the MAIN unit J-54

to the MAIN unit J-55

to the MAIN unit J-56

to the MAIN unit J-57

to the MAIN unit J-58

to the MAIN unit J-59

to the MAIN unit J-60

to the MAIN unit J-61

to the MAIN unit J-62

to the MAIN unit J-63

to the MAIN unit J-64

to the MAIN unit J-65

to the MAIN unit J-66

to the MAIN unit J-67

to the MAIN unit J-68

to the MAIN unit J-69

to the MAIN unit J-70

to the MAIN unit J-71

to the MAIN unit J-72

to the MAIN unit J-73

to the MAIN unit J-74

to the MAIN unit J-75

to the MAIN unit J-76

to the MAIN unit J-77

to the MAIN unit J-78

to the MAIN unit J-79

to the MAIN unit J-80

to the MAIN unit J-81

to the MAIN unit J-82

to the MAIN unit J-83

to the MAIN unit J-84

to the MAIN unit J-85

to the MAIN unit J-86

to the MAIN unit J-87

to the MAIN unit J-88

to the MAIN unit J-89

to the MAIN unit J-90

to the MAIN unit J-91

to the MAIN unit J-92

to the MAIN unit J-93

to the MAIN unit J-94

to the MAIN unit J-95

to the MAIN unit J-96

to the MAIN unit J-97

to the MAIN unit J-98

to the MAIN unit J-99

to the MAIN unit J-100

• BOTTOM VIEW (RXPLL-B UNIT)

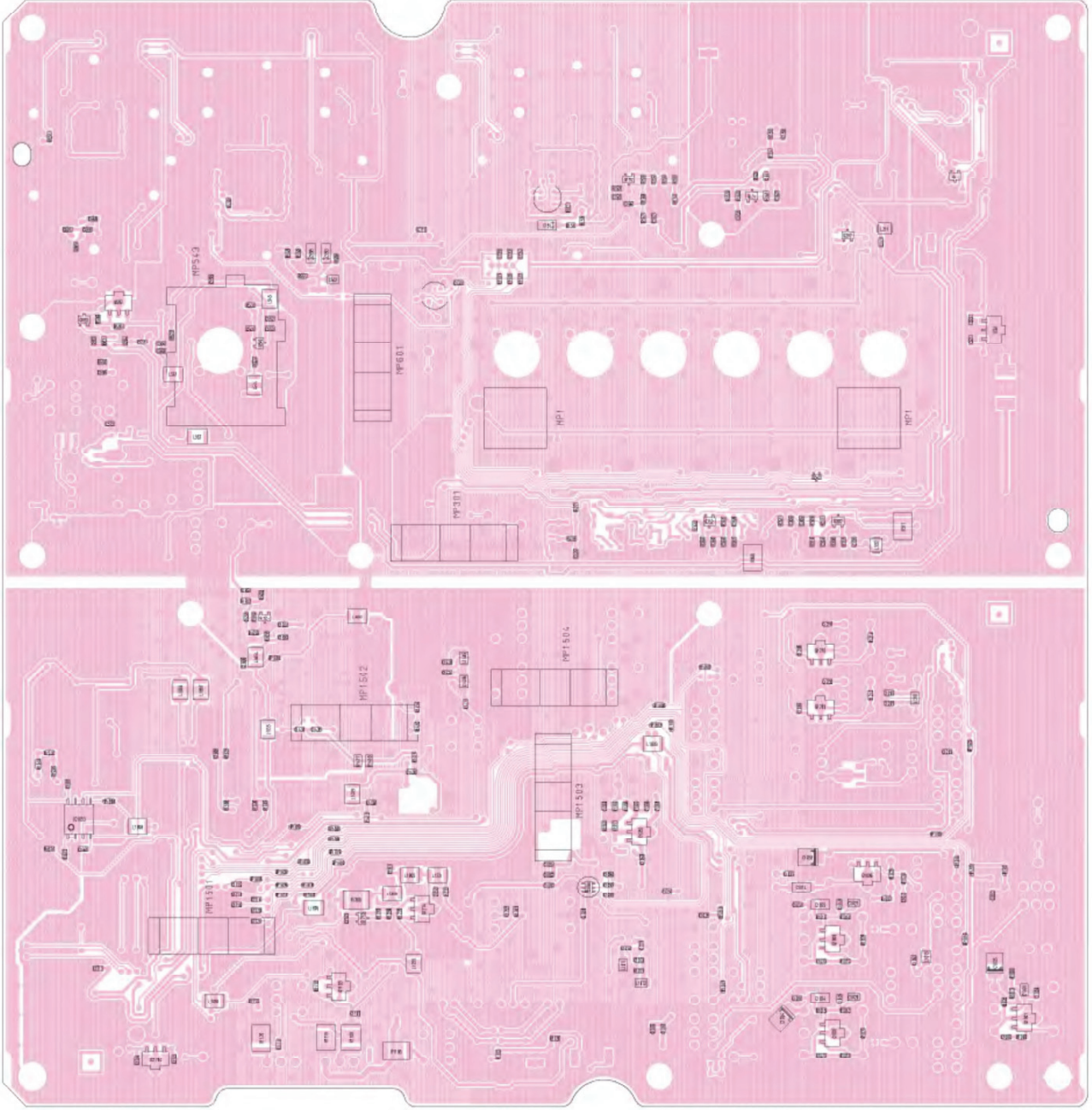

8-24 DIGISEL UNIT
• TOP VIEW

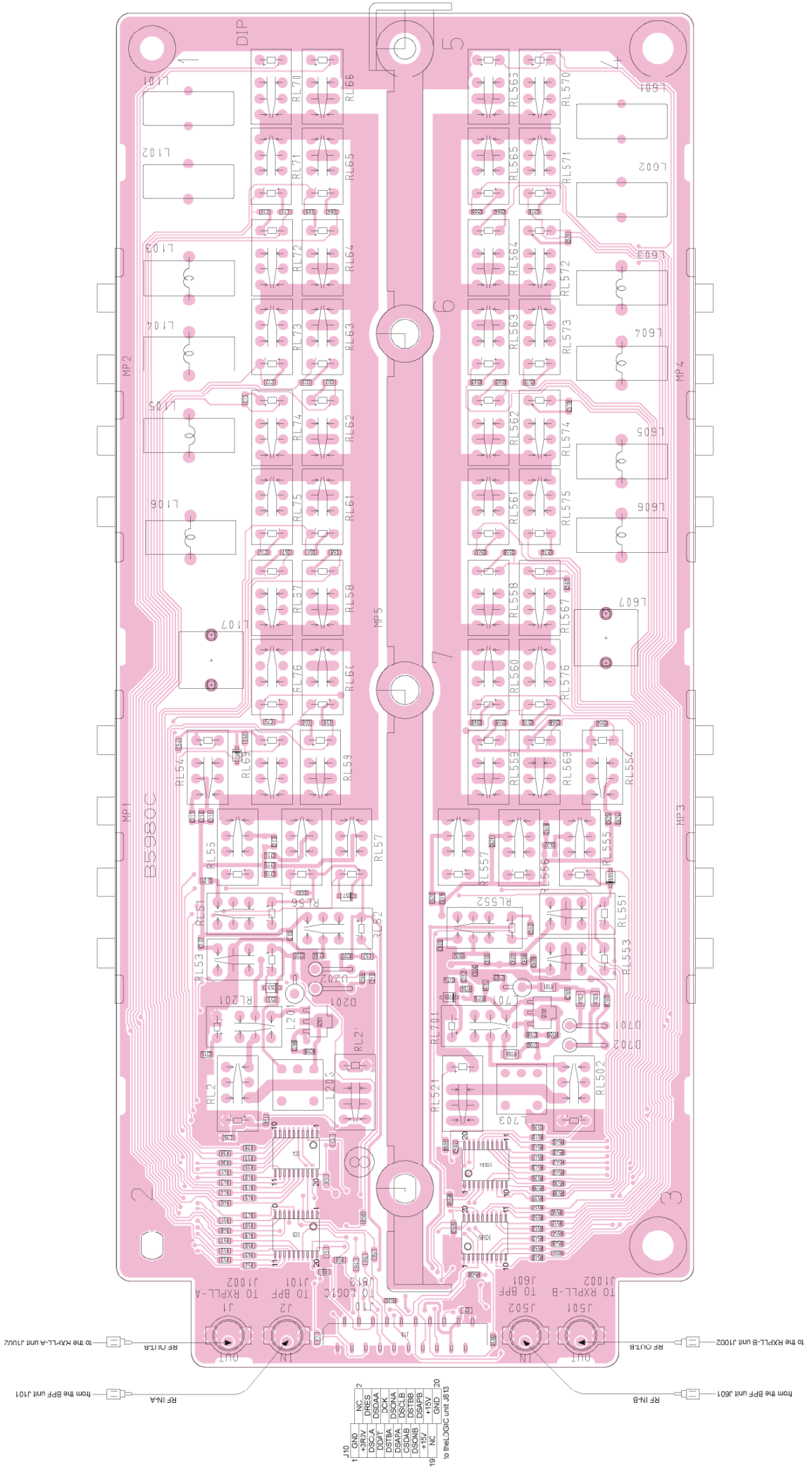

1	10	NC	to the LOGIC unit J813
2	11	NC	
3	12	NC	
4	13	NC	
5	14	NC	
6	15	NC	
7	16	NC	
8	17	NC	
9	18	NC	
10	19	NC	
11	20	NC	
12	21	NC	
13	22	NC	
14	23	NC	
15	24	NC	
16	25	NC	
17	26	NC	
18	27	NC	
19	28	NC	
20	29	NC	
21	30	NC	
22	31	NC	
23	32	NC	
24	33	NC	
25	34	NC	
26	35	NC	
27	36	NC	
28	37	NC	
29	38	NC	
30	39	NC	
31	40	NC	
32	41	NC	
33	42	NC	
34	43	NC	
35	44	NC	
36	45	NC	
37	46	NC	
38	47	NC	
39	48	NC	
40	49	NC	
41	50	NC	
42	51	NC	
43	52	NC	
44	53	NC	
45	54	NC	
46	55	NC	
47	56	NC	
48	57	NC	
49	58	NC	
50	59	NC	
51	60	NC	
52	61	NC	
53	62	NC	
54	63	NC	
55	64	NC	
56	65	NC	
57	66	NC	
58	67	NC	
59	68	NC	
60	69	NC	
61	70	NC	
62	71	NC	
63	72	NC	
64	73	NC	
65	74	NC	
66	75	NC	
67	76	NC	
68	77	NC	
69	78	NC	
70	79	NC	
71	80	NC	
72	81	NC	
73	82	NC	
74	83	NC	
75	84	NC	
76	85	NC	
77	86	NC	
78	87	NC	
79	88	NC	
80	89	NC	
81	90	NC	
82	91	NC	
83	92	NC	
84	93	NC	
85	94	NC	
86	95	NC	
87	96	NC	
88	97	NC	
89	98	NC	
90	99	NC	
91	100	NC	

• BOTTOM VIEW (DIGISEL UNIT)

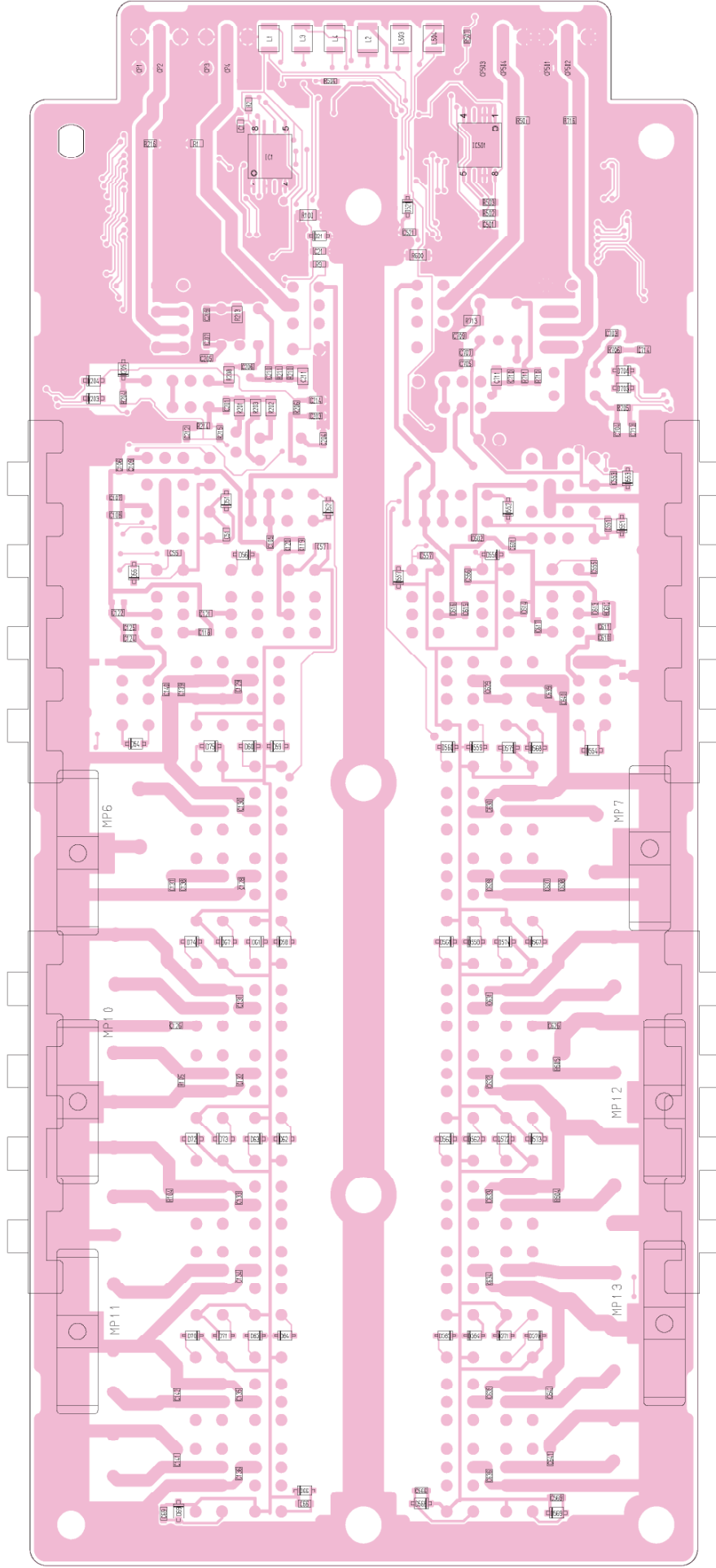

8-25 OSC UNIT
• TOP VIEW

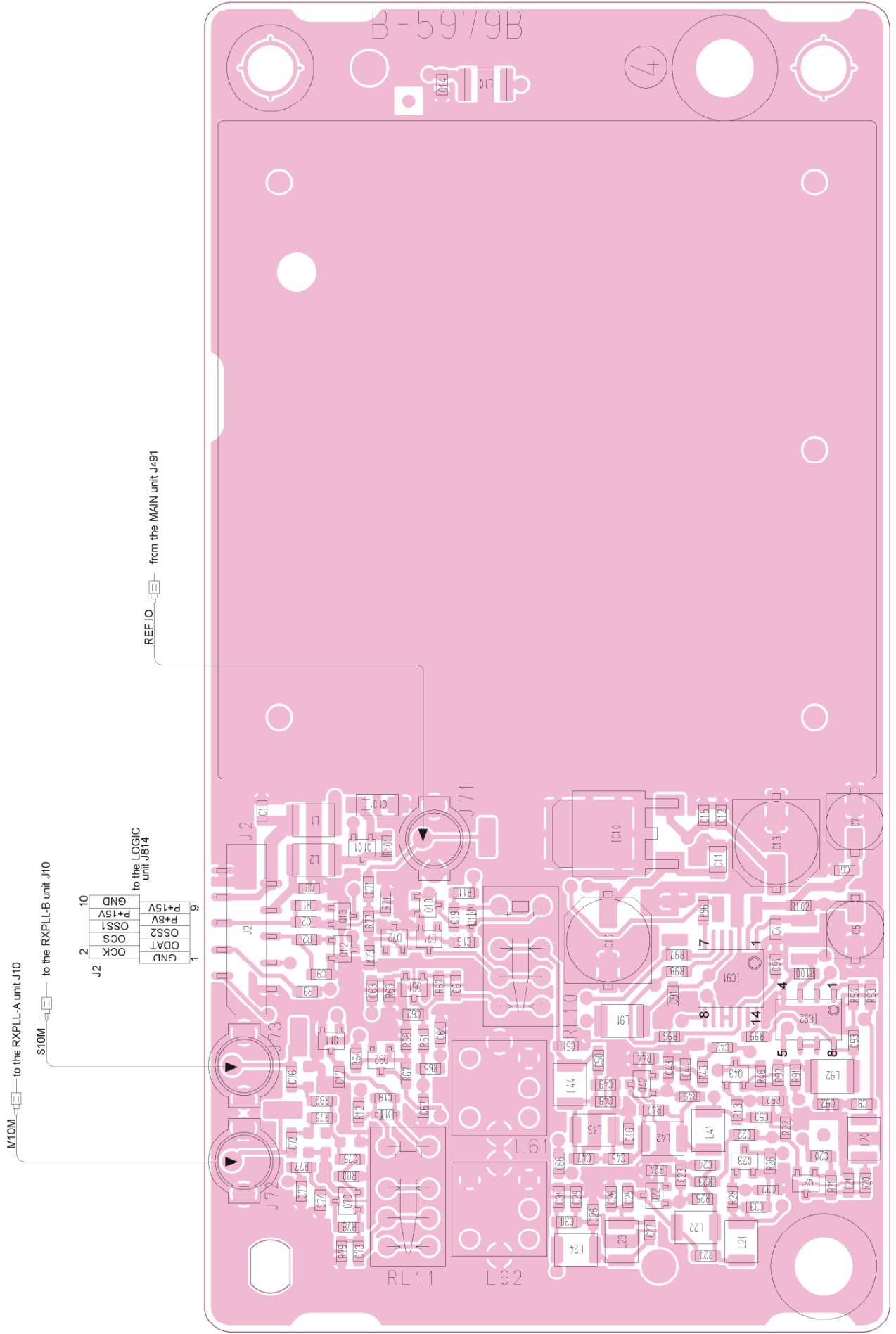

• BOTTOM VIEW (OSC UNIT)

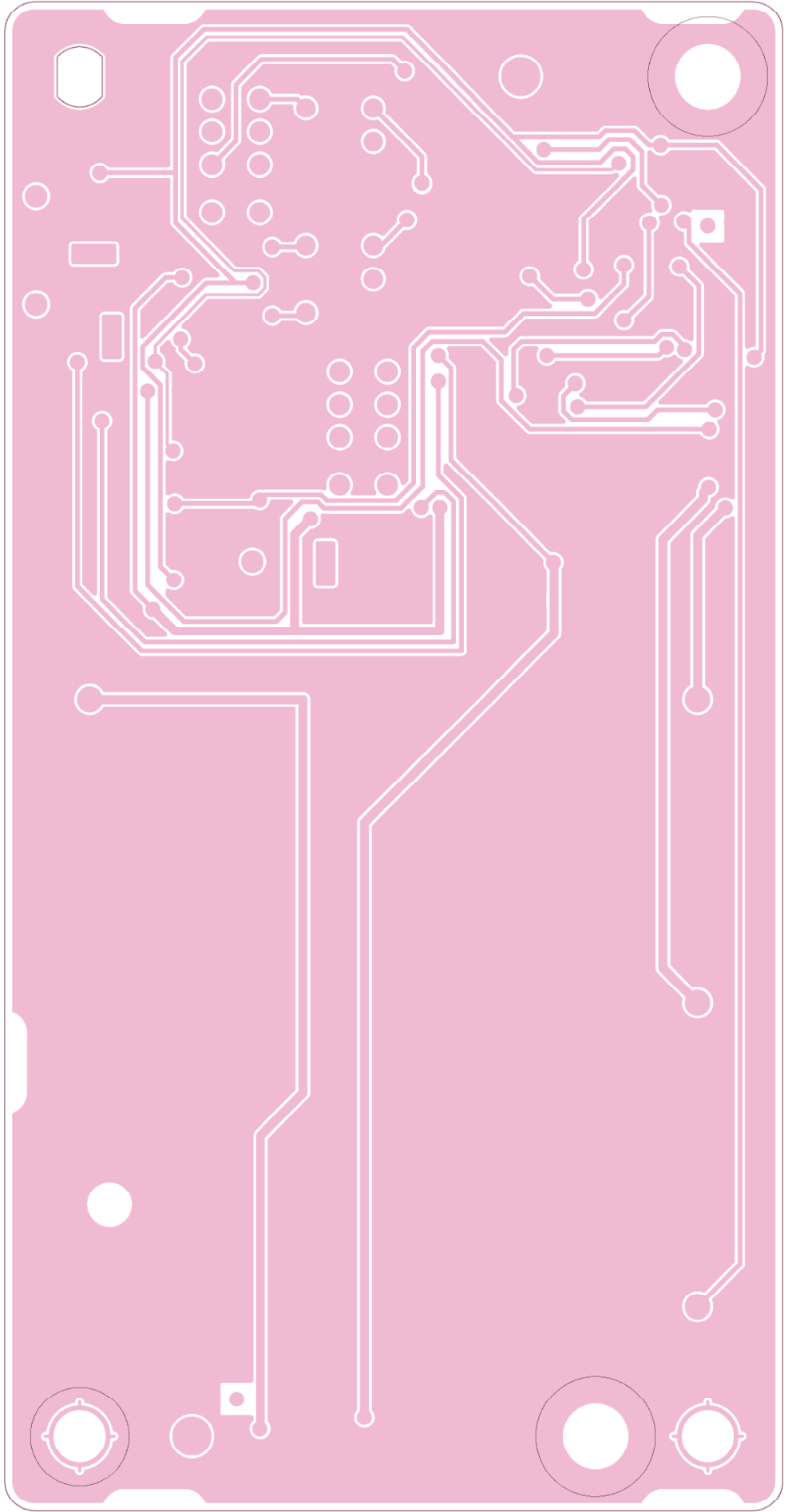

8-26 ANT-SW UNIT
• TOP VIEW

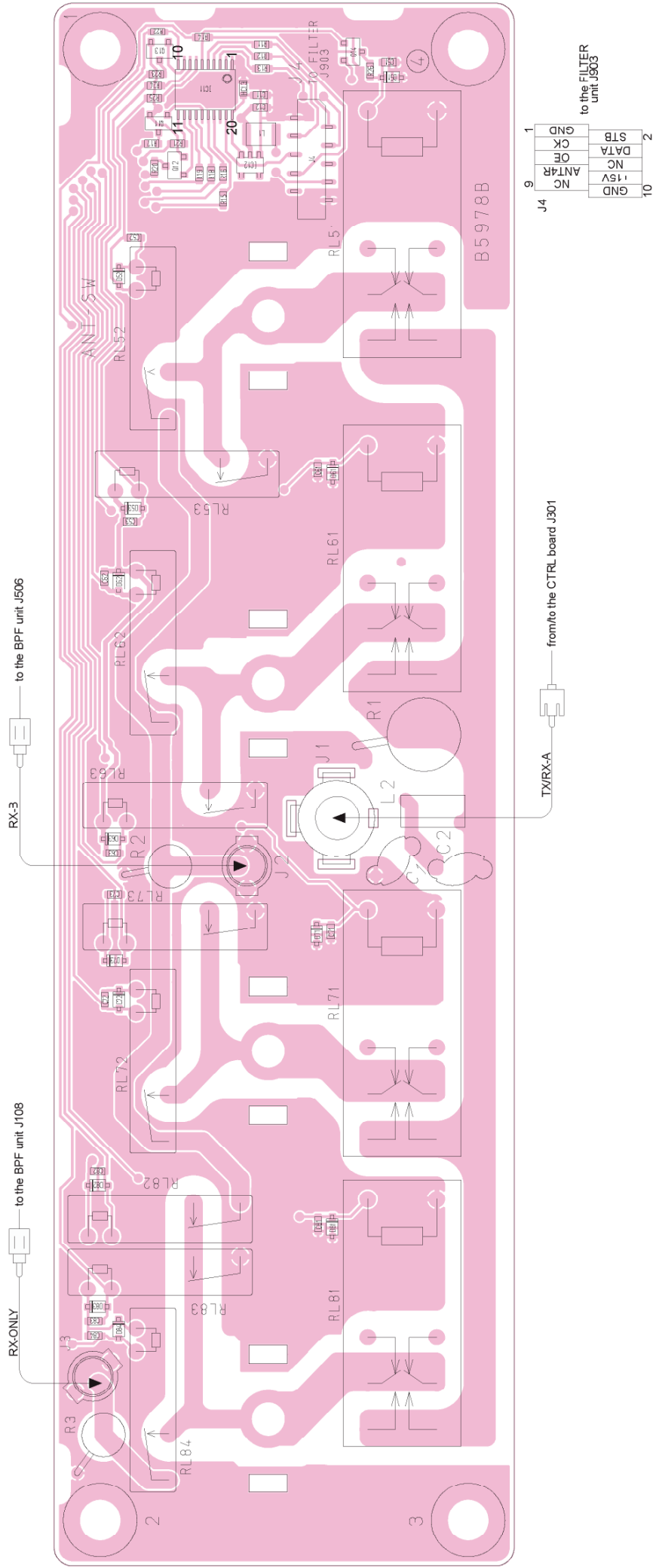

• BOTTOM VIEW (ANT-SW UNIT)

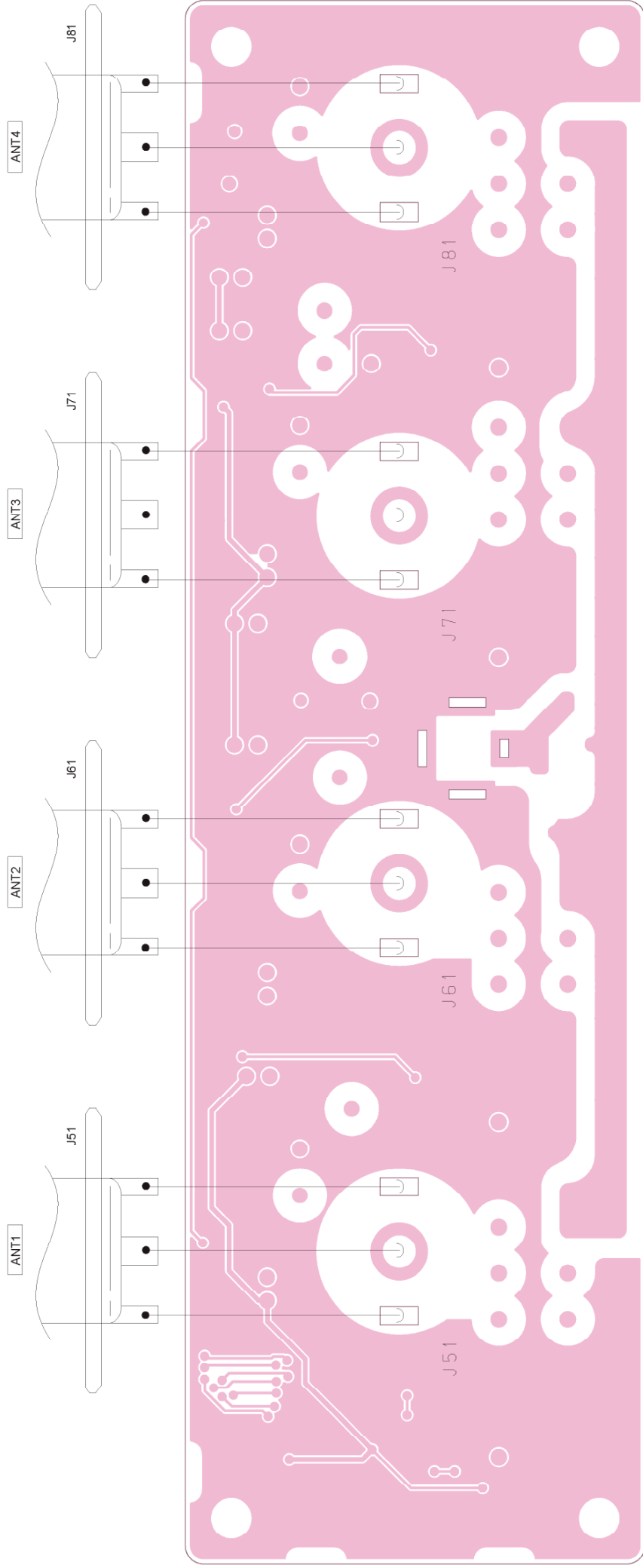

8-27 FILTER UNIT

• TOP VIEW

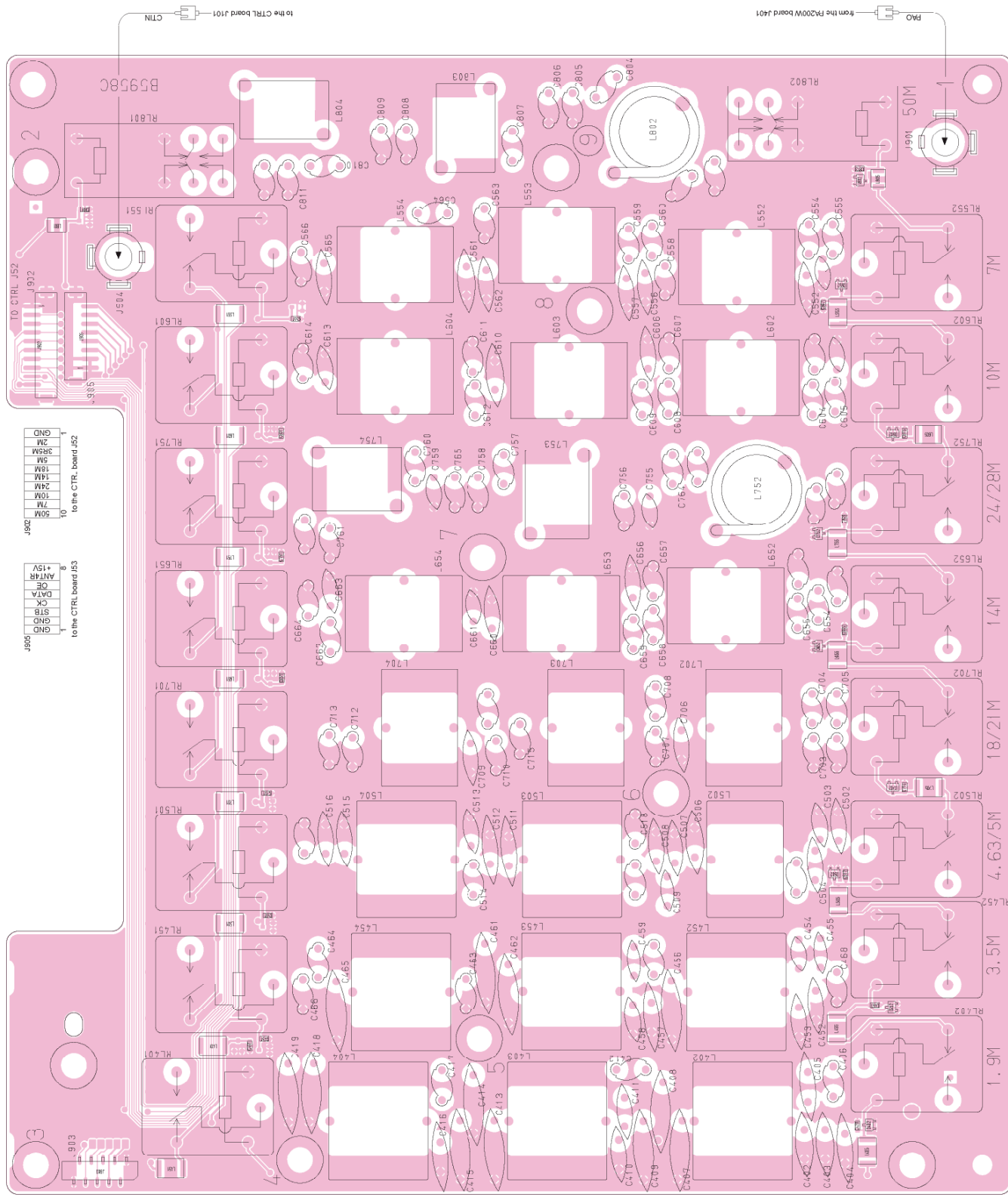

J902 to the CTRL. board J52

1	GND
2	50M
3	7M
4	10M
5	24M
6	18M
7	18M
8	38M
9	2M
10	GND

J901 to the CTRL. board J53

1	GND
2	STR
3	DATA
4	CK
5	ANTEN
6	+15V

J903 to the ANT-SW unit L4

1	GND
2	NC
3	DATA
4	STR
5	NC
6	ANTEN
7	NC
8	DATA
9	STR
10	GND

• BOTTOM VIEW (FILTER UNIT)

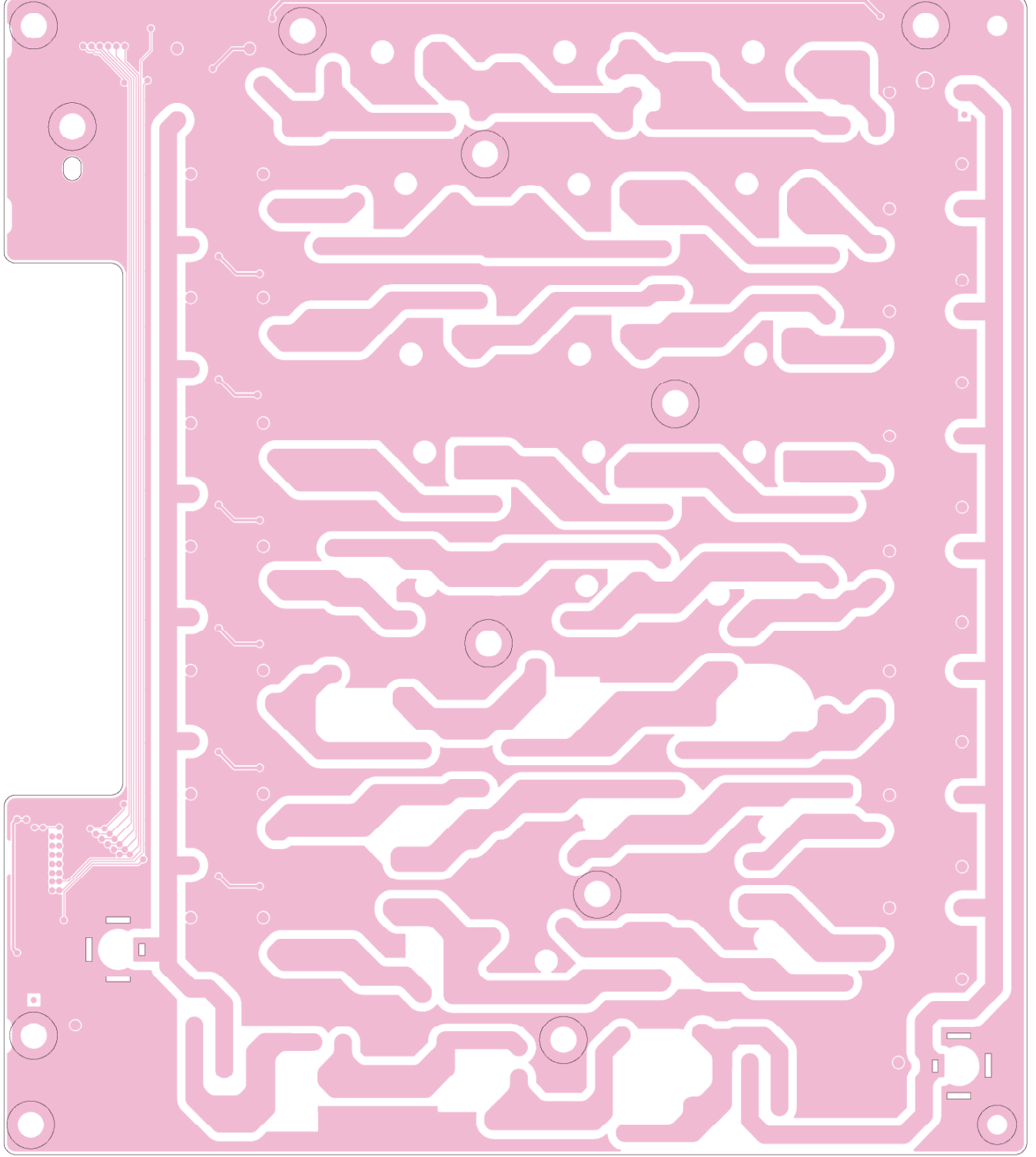

• BOTTOM VIEW (NETWORK BOARD)

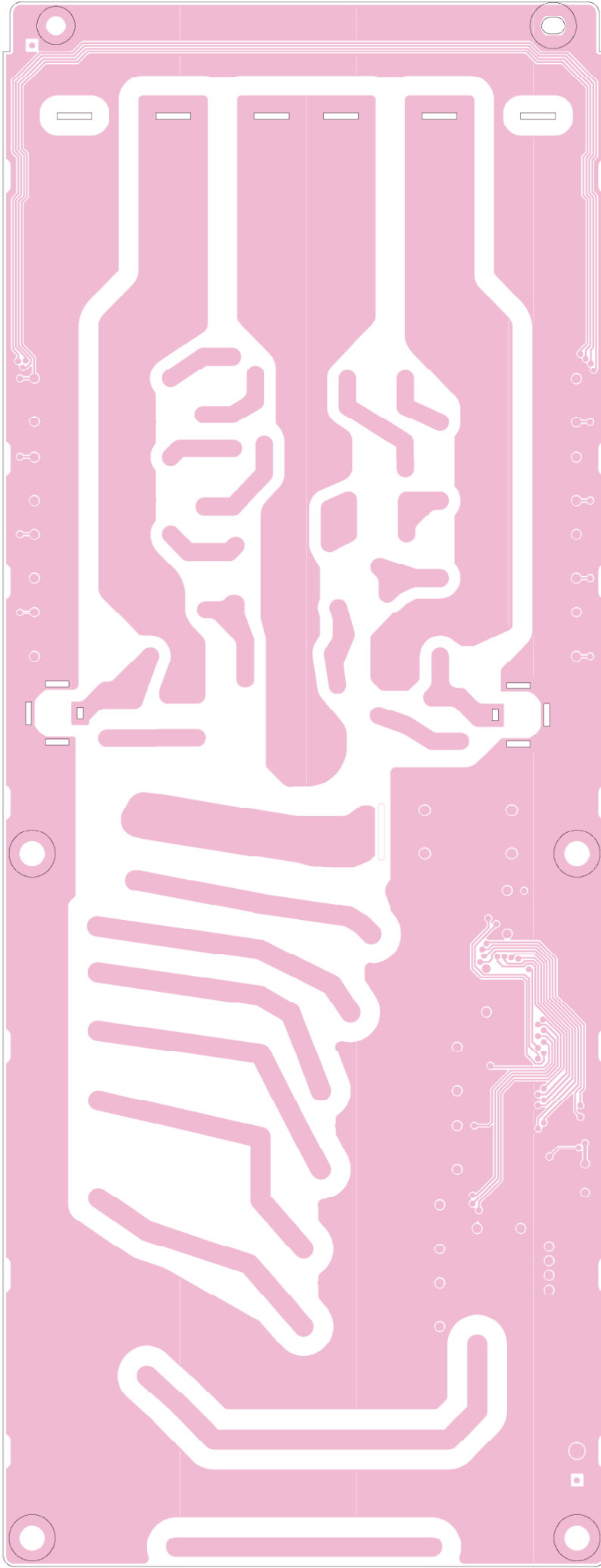

8-29 CTRL BOARD
• TOP VIEW

J51 to the NETWORK board J1

1	GND
2	GND
3	250M
4	5M
5	7M
6	14M
7	18M
8	24M
9	VHF
10	GND
11	FAN
12	+15V
13	+15V
14	CO3
15	CO2
16	CO1
17	VHCO
18	VHCH
19	CS
20	CS
21	CS
22	CS
23	CS
24	GND

J1 to the LOGIC unit J811

1	+15V
2	+15V
3	GND
4	GND
5	+15V
6	GND
7	FORX
8	REFV
9	GND
10	TOE
11	F18
12	CS18
13	TOAT
14	TOK
15	GND
16	TOE
17	GND
18	IS1A
19	KEY
20	CH1
21	GND
22	IS1A
23	KEY
24	GND

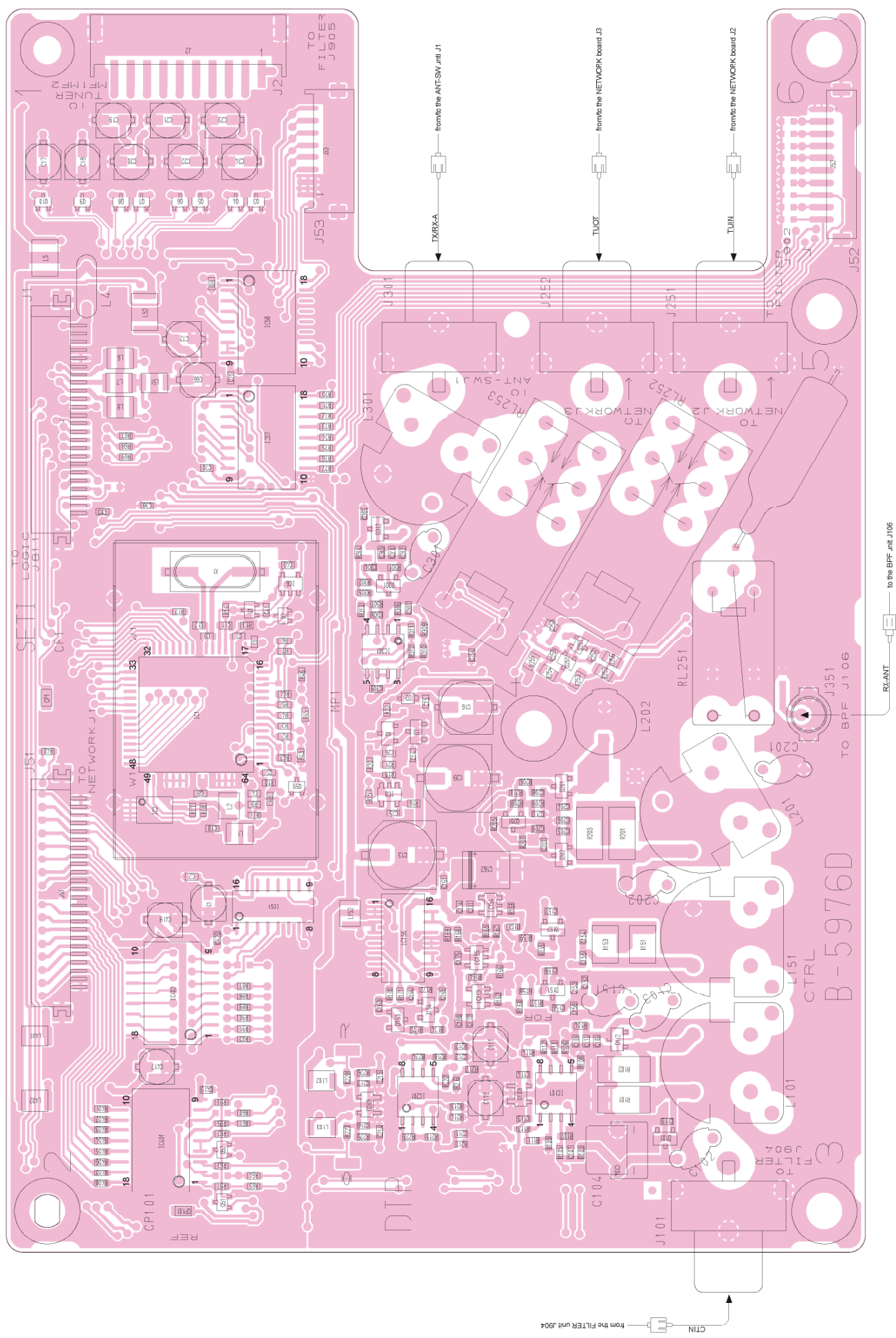

J2 to the TUNER unit J1002

1	TX
2	TX
3	TX
4	TX
5	TX
6	TX
7	TX
8	TX
9	TX
10	TX

J53 to the FILTER unit J905

1	GND
2	GND
3	GND
4	GND
5	GND
6	GND
7	GND
8	GND
9	GND
10	GND

J52 to the FILTER unit J902

1	50M
2	7M
3	10M
4	24M
5	14M
6	18M
7	5M
8	365M
9	2M
10	GND

• BOTTOM VIEW (CTRL BOARD)

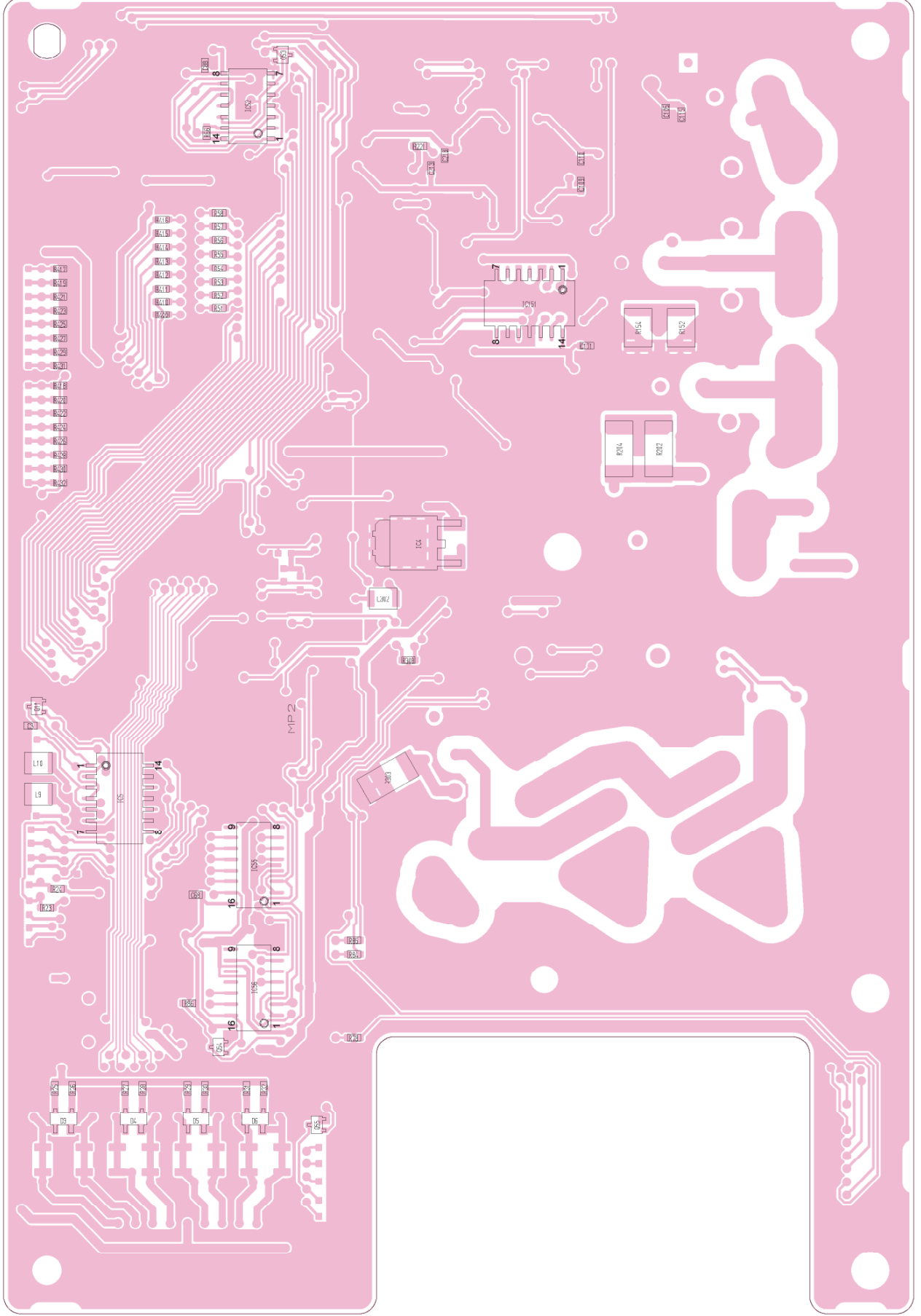

• BOTTOM VIEW (BPF UNIT)

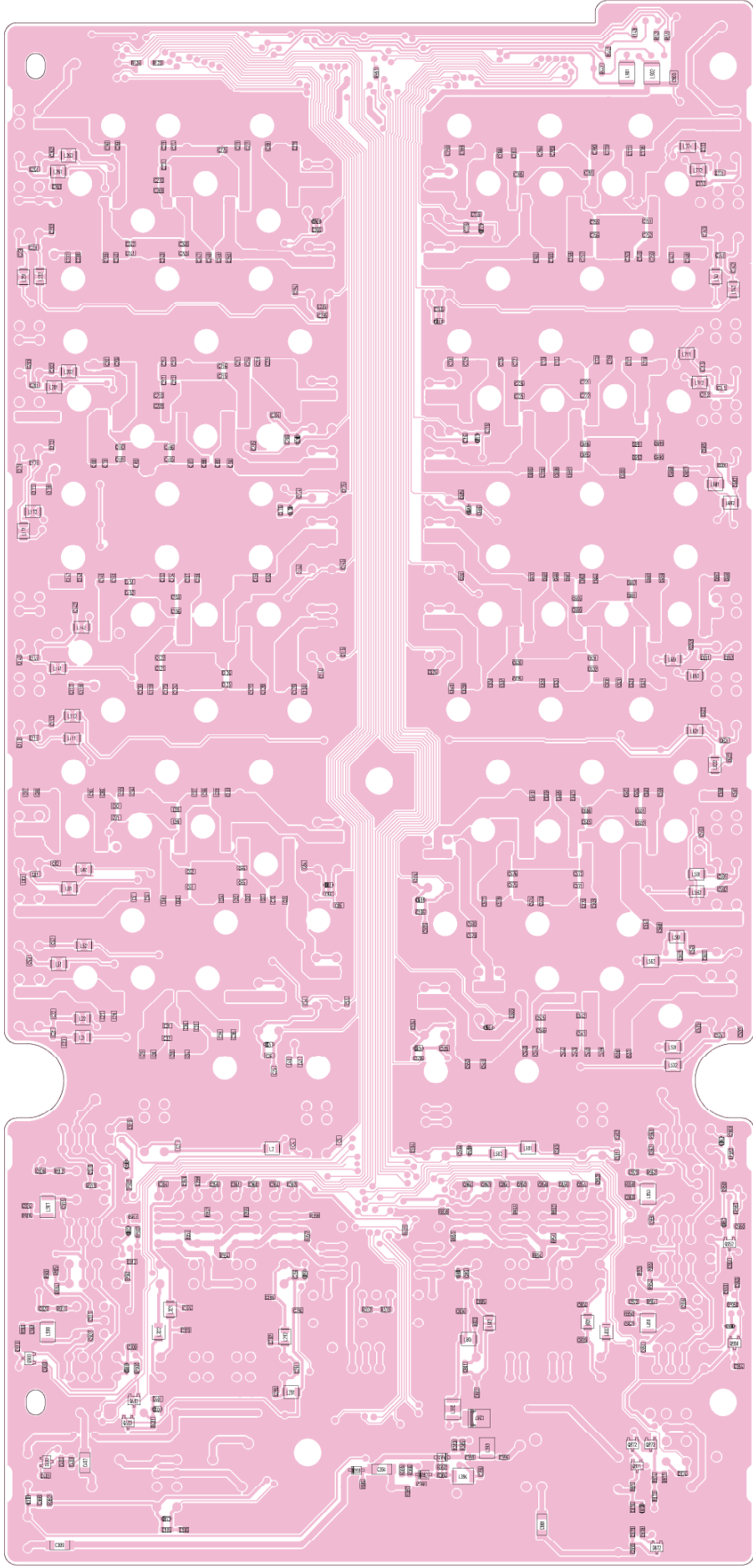

8-31 PA200W BOARD
• TOP VIEW

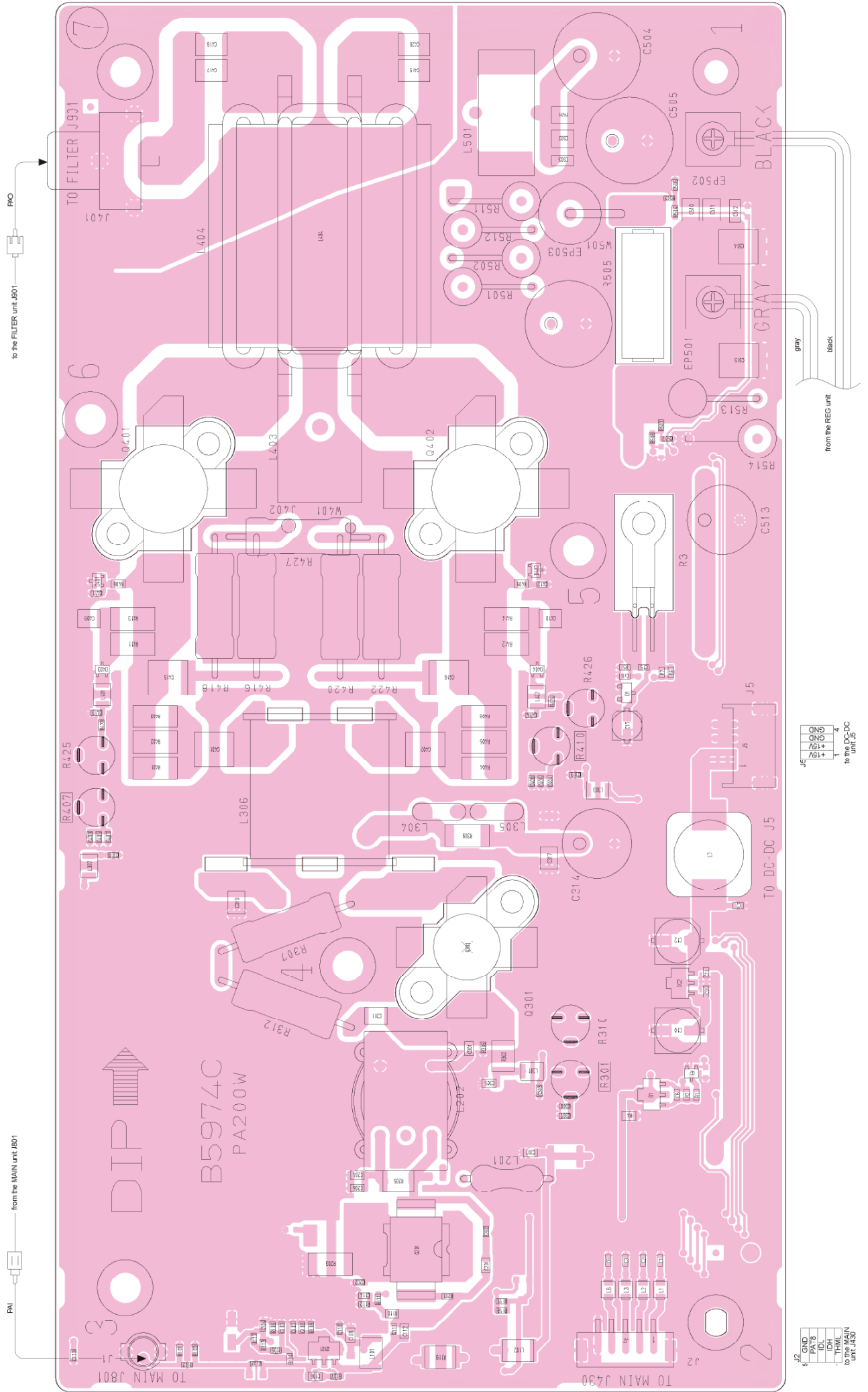

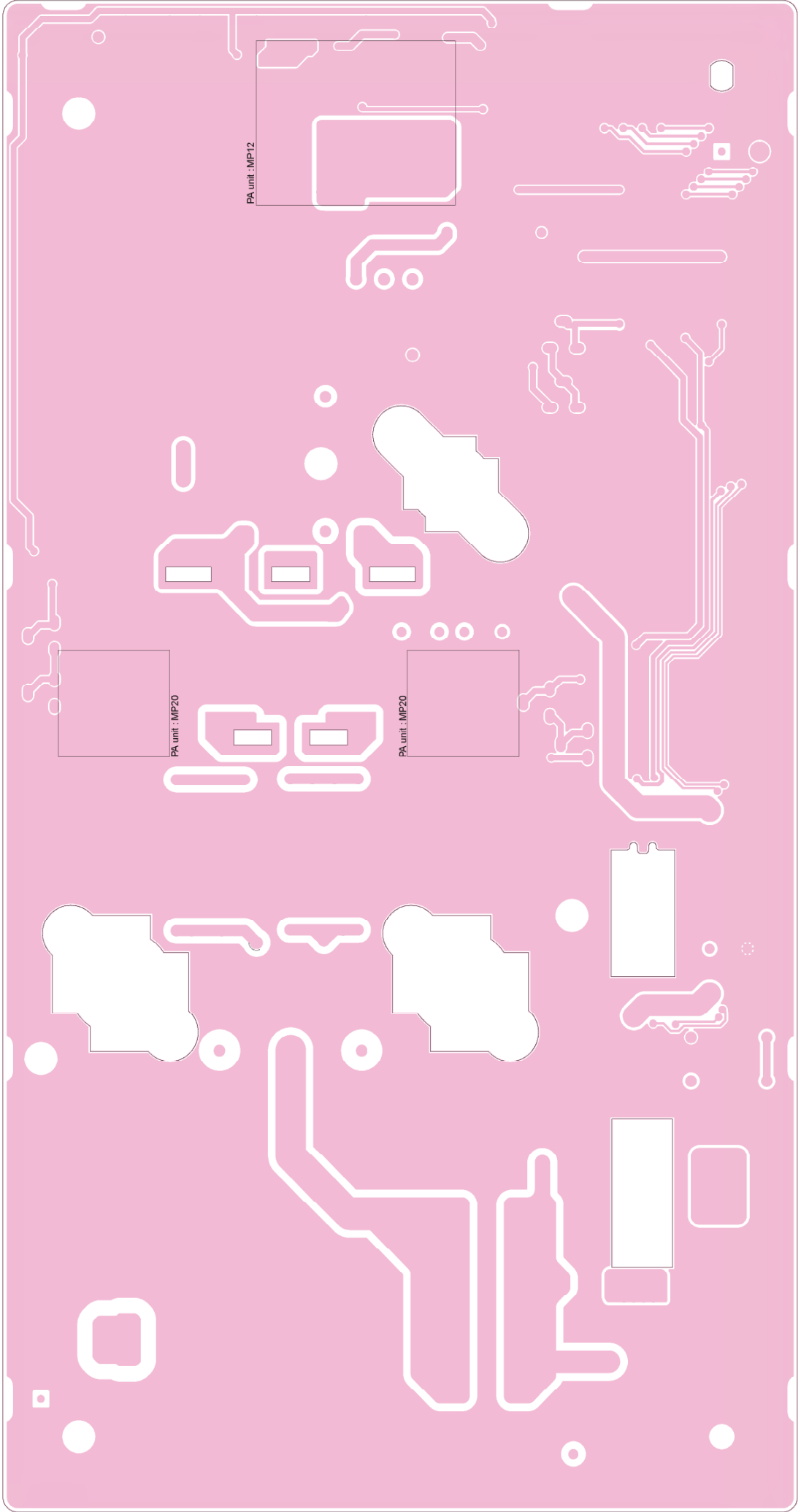

8-32 DC-DC UNIT
• TOP VIEW

to the LOGIC unit J820

10	GND
9	+3R3V
8	+5V
7	+8V
6	+15V
5	+15V
4	+15V
3	-12V
2	GND
1	LG PWR

to the LOGIC unit J821

7	GND
6	C15V
5	PWR3
4	VDD5
3	VDD3R3
2	VDD1R5
1	GND

to the MAIN unit J450

11	GND
10	VDD5
9	GND
8	+3R3V
7	+3R3V
6	+5V
5	+8V
4	+15V
3	-12V
2	GND
1	J2

W1 to the REG unit

10	H8V
9	H8V
8	GND
7	GND
6	GND
5	C15V
4	C15V
3	LG PWR
2	GND
1	to the REG unit

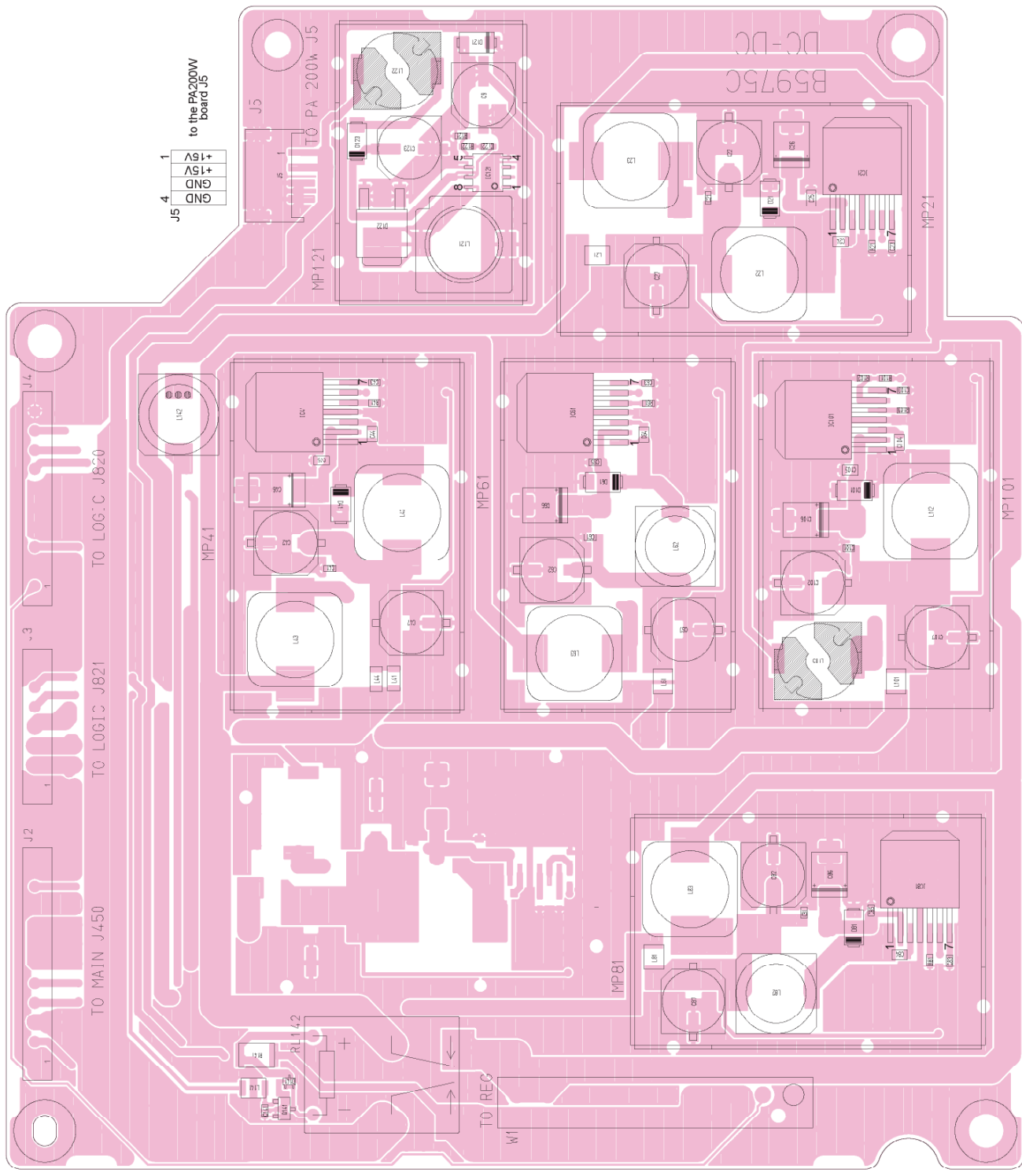

J5 to the PA200W board JS

1	+15V
2	+15V
3	GND
4	GND
5	J5

• BOTTOM VIEW (DC-DC UNIT)

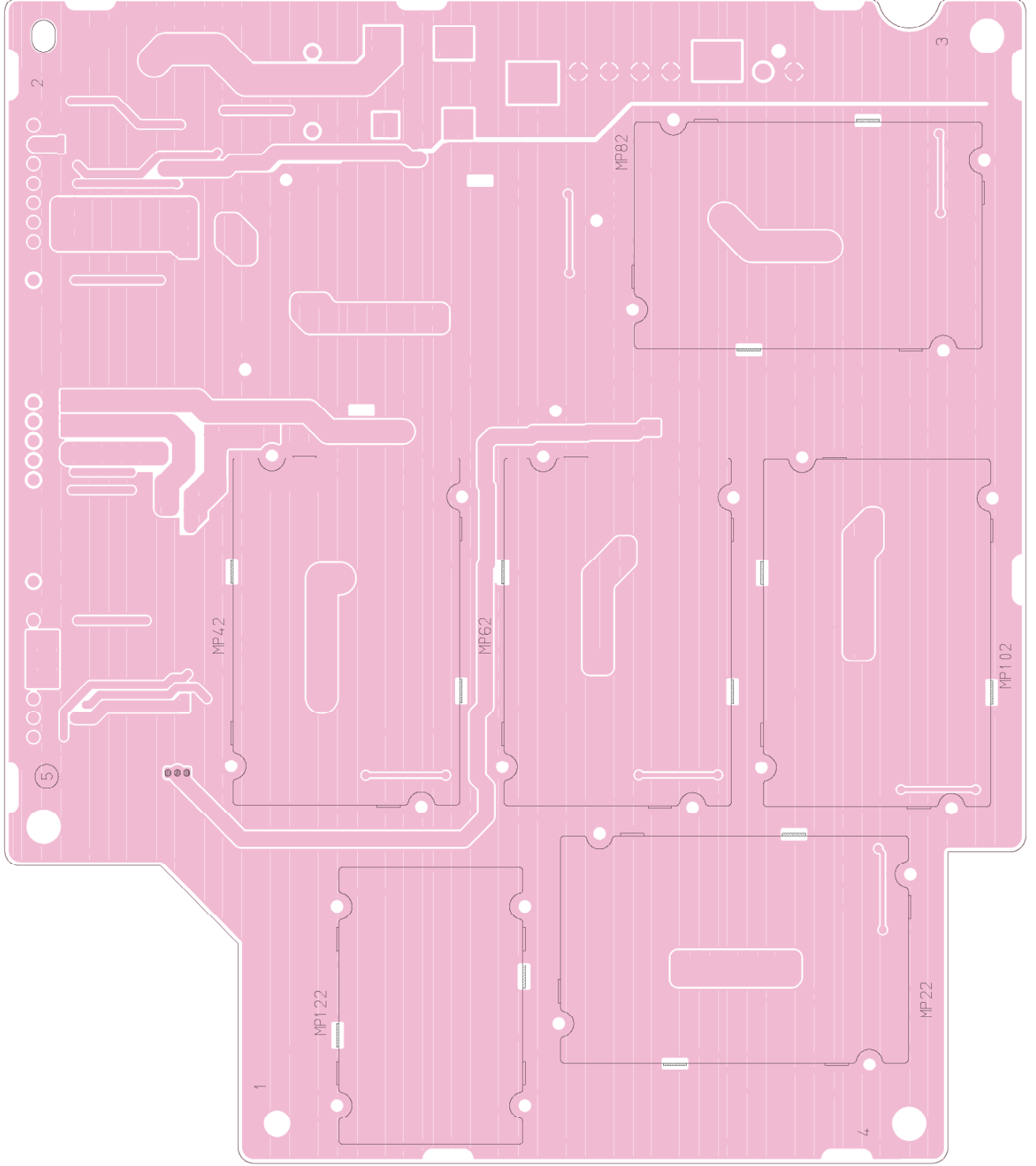

SECTION 9 BLOCK DIAGRAMS

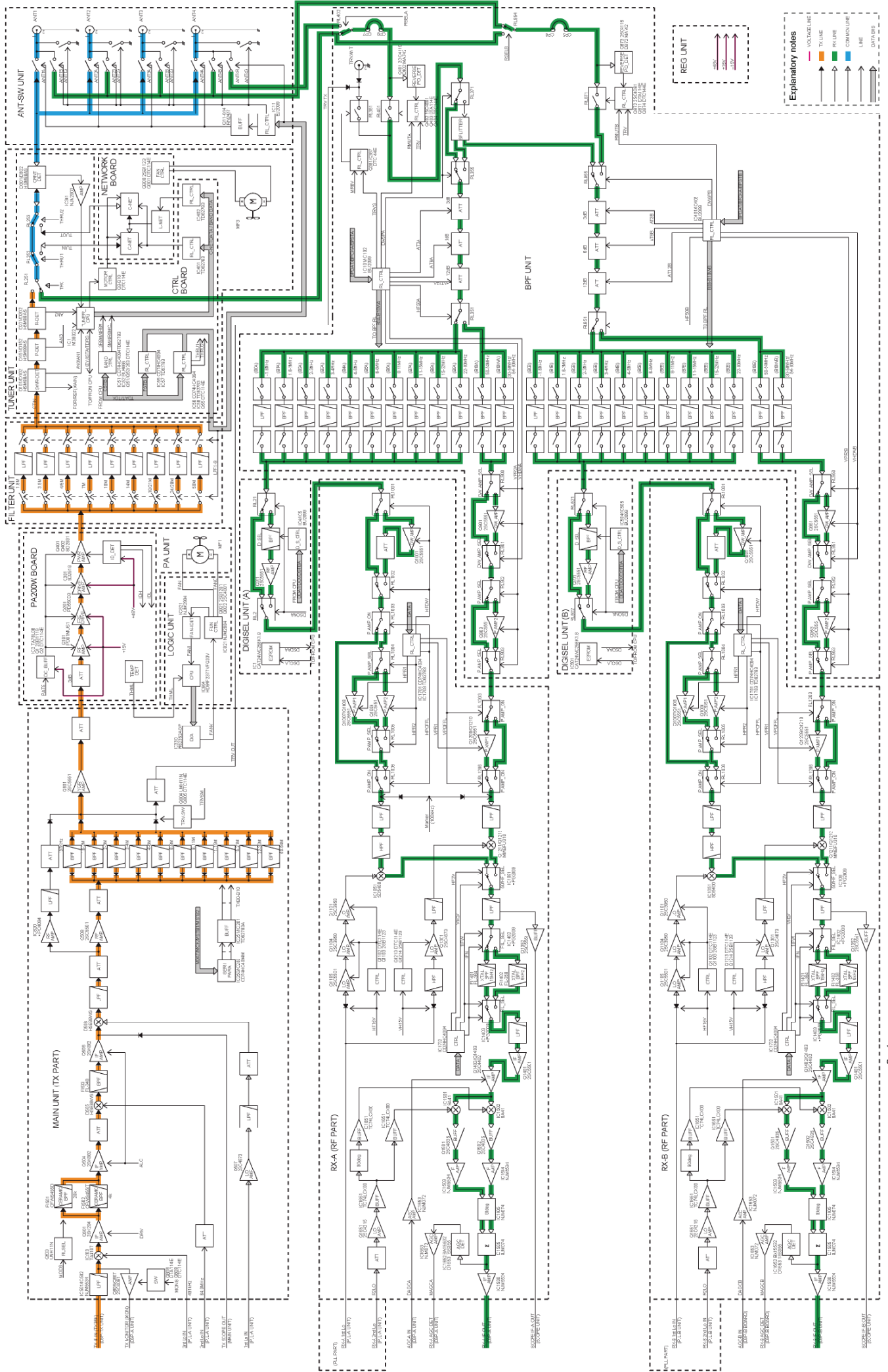

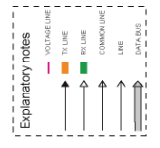
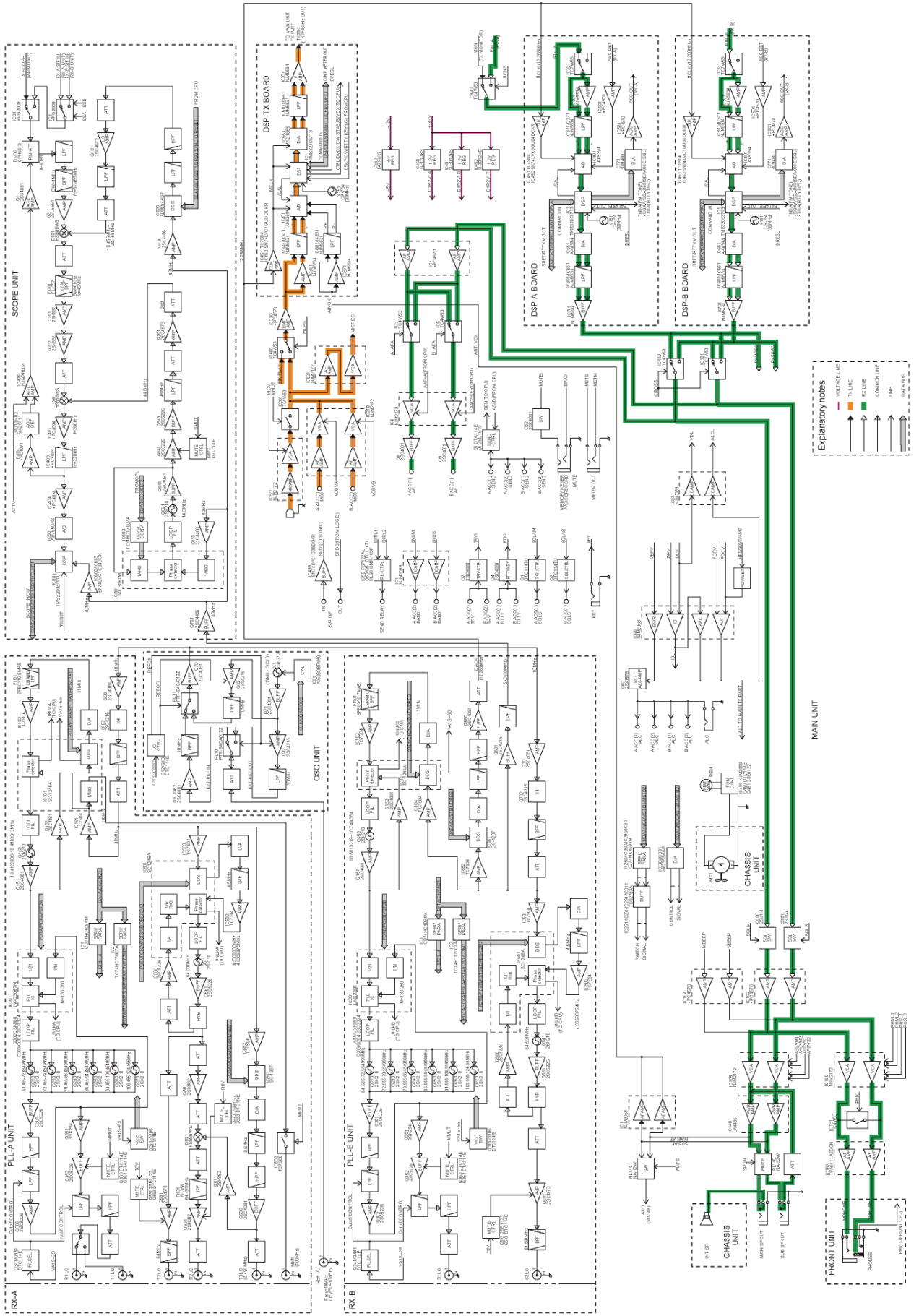

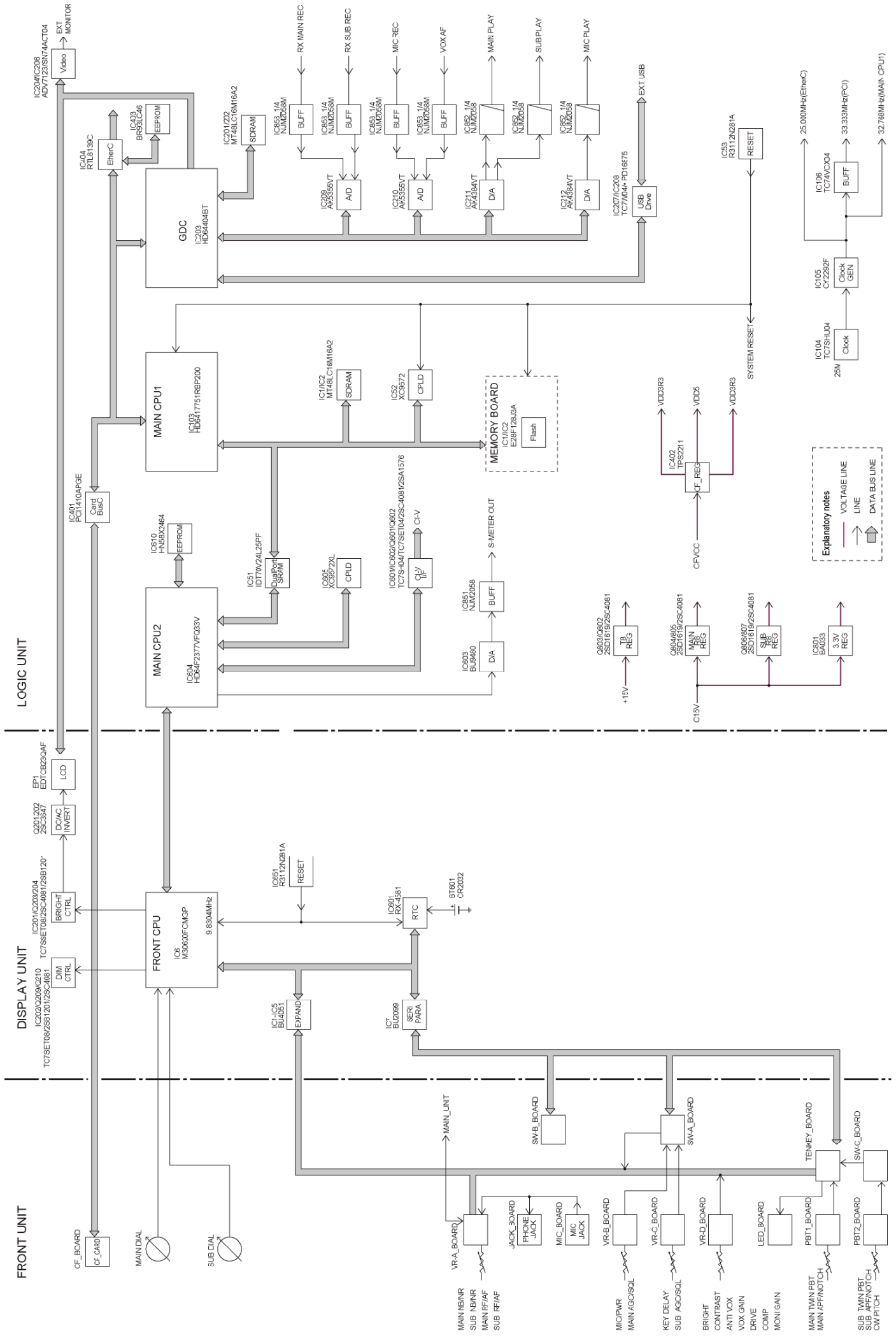

SECTION 10 WIRING DIAGRAMS

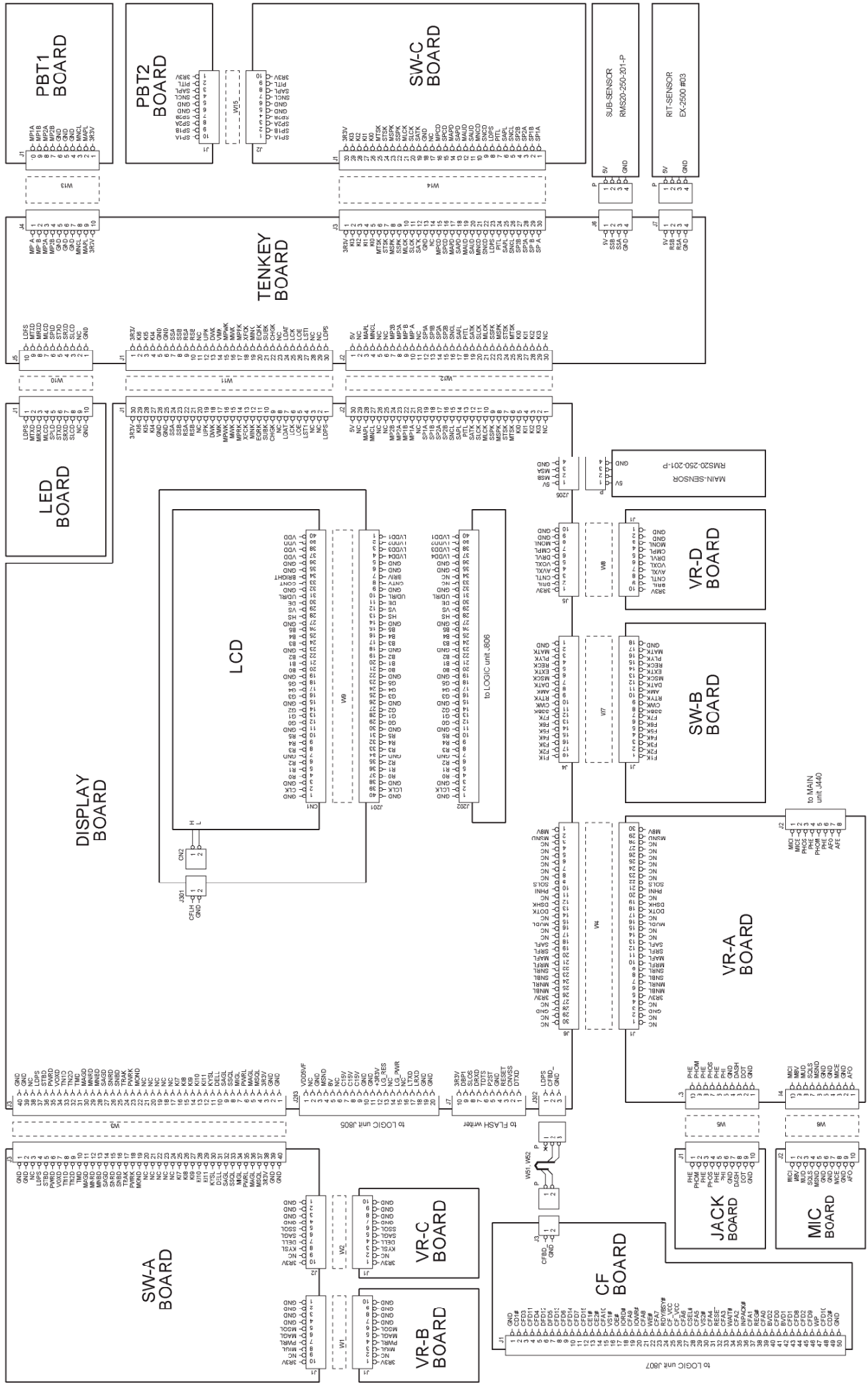

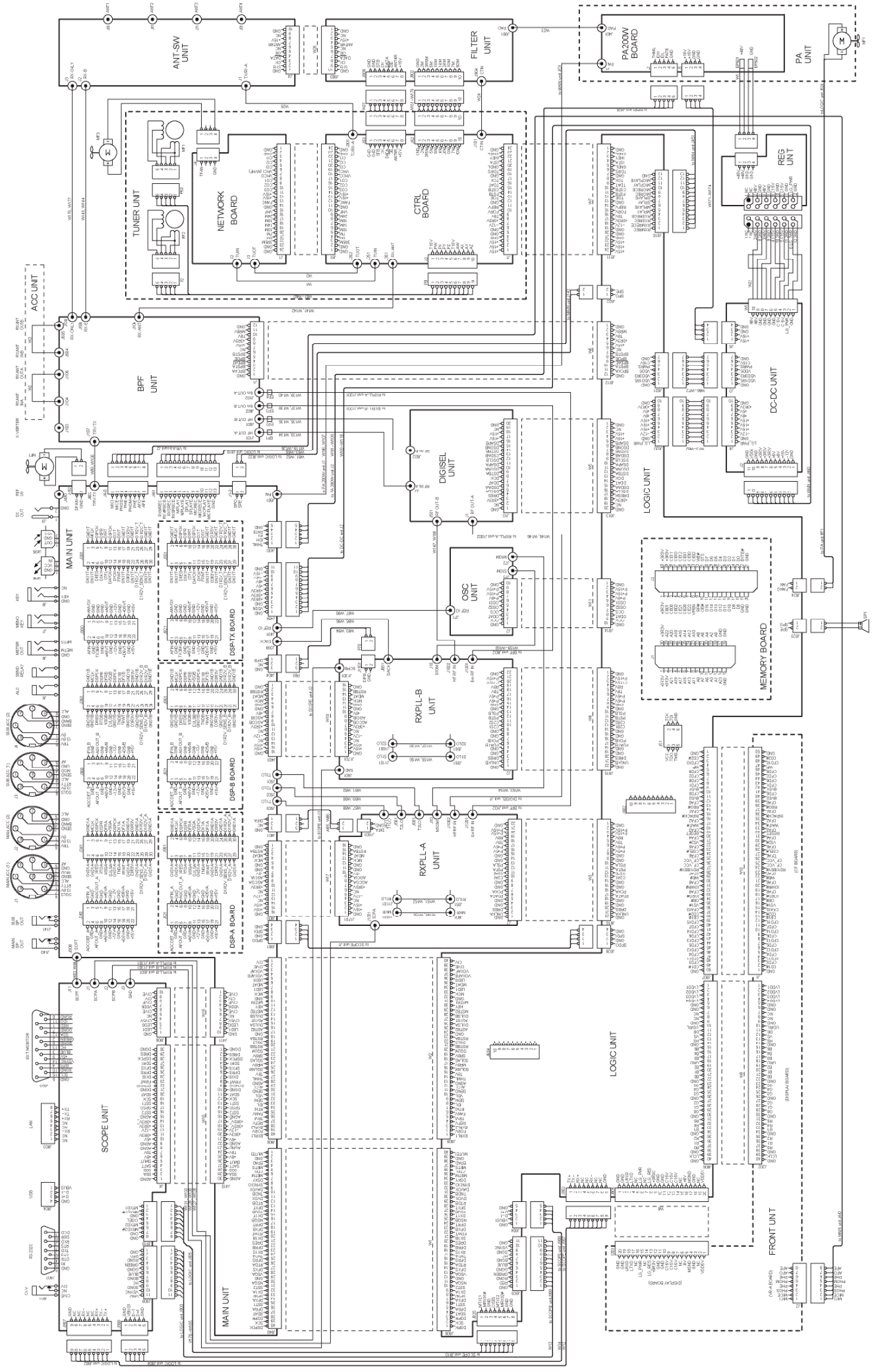

SECTION 11 VOLTAGE DIAGRAMS

11-1 DISPLAY BOARD

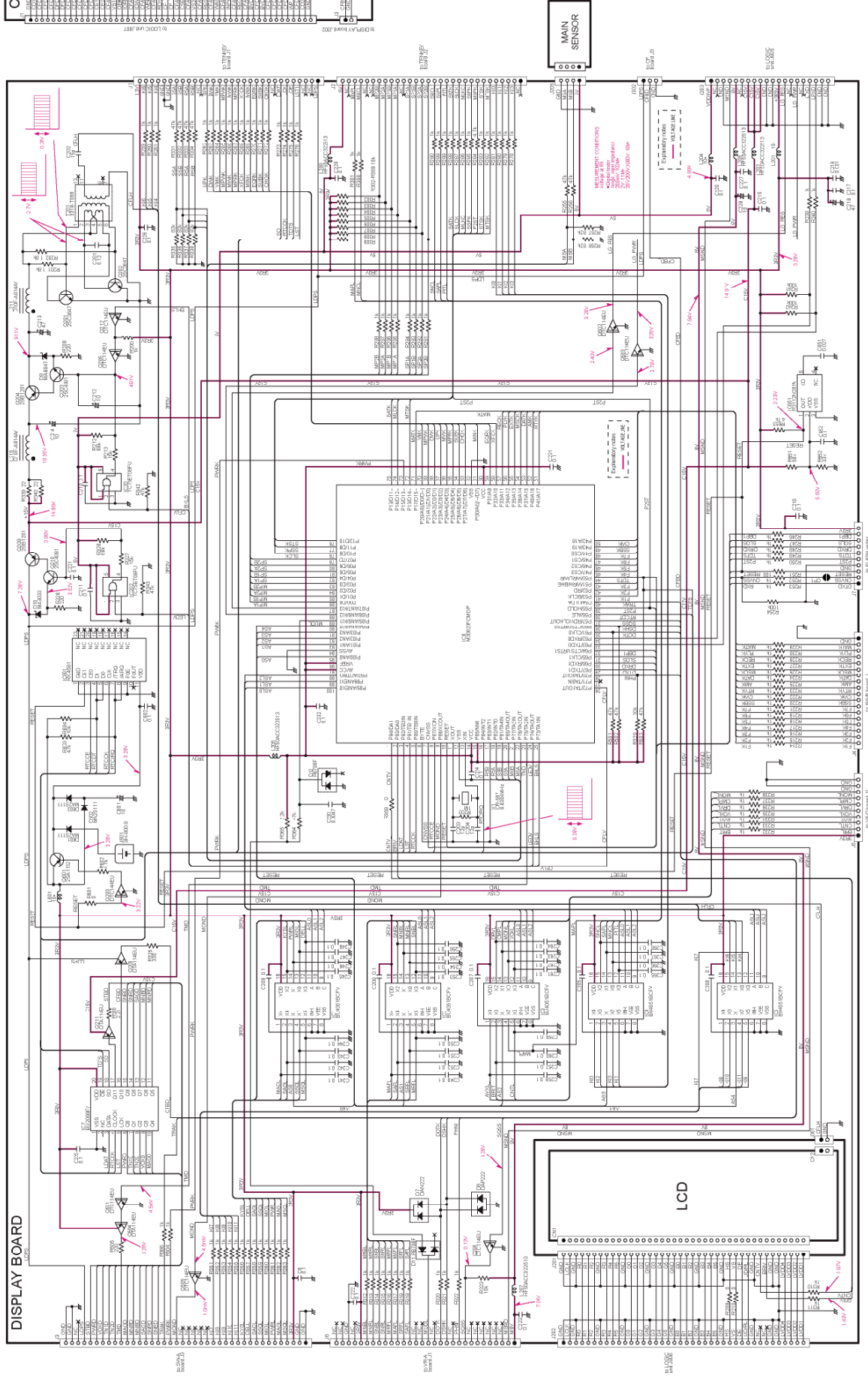

11-2 CF BOARD

11-3 SW-A BOARD

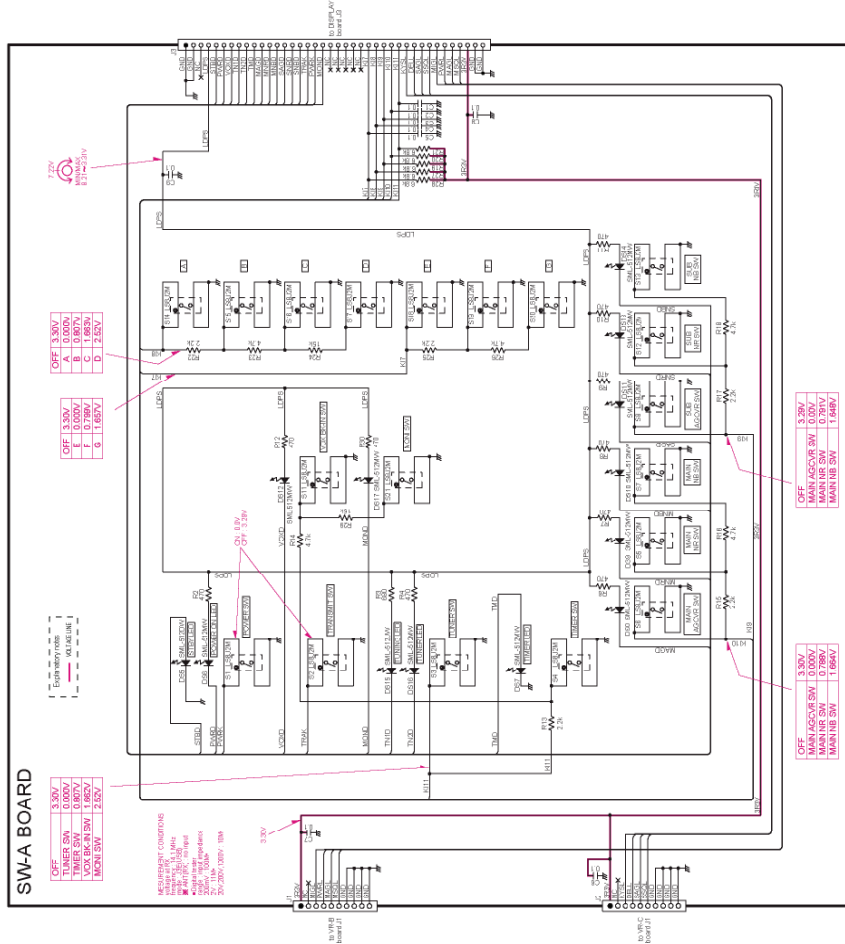

11-6 VR-A BOARD

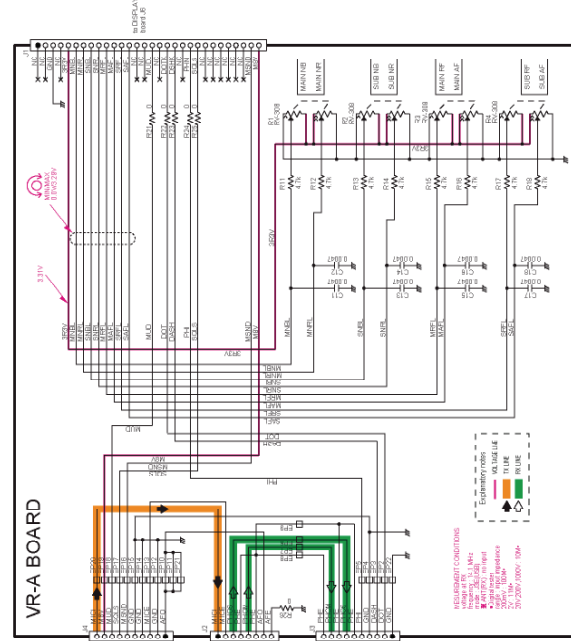

11-9 VR-D BOARD

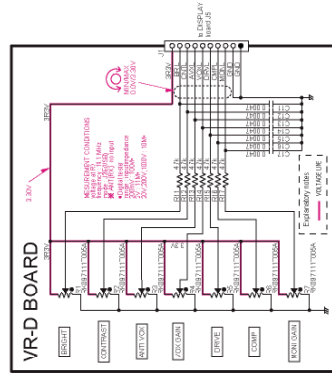

11-7 MIC BOARD

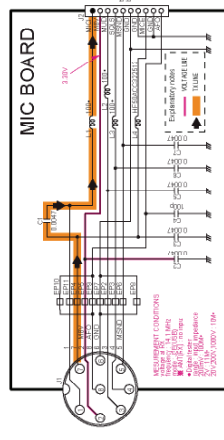

11-10 SW-B BOARD

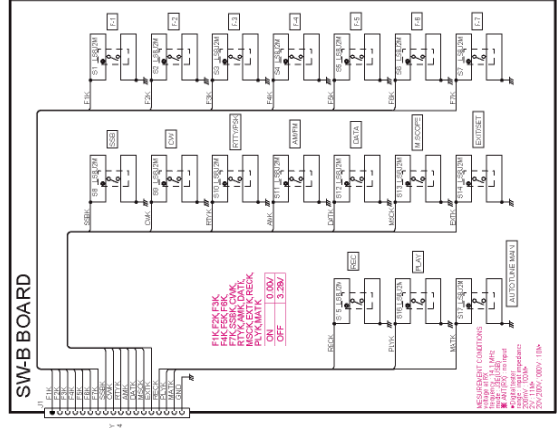

11-4 VR-B BOARD

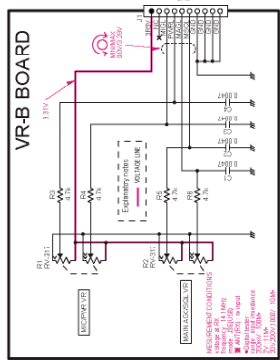

11-5 VR-C BOARD

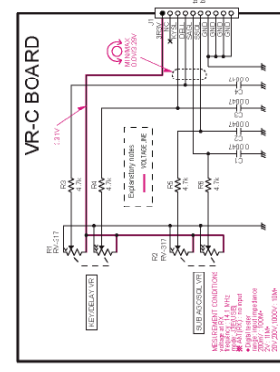

11-8 JACK BOARD

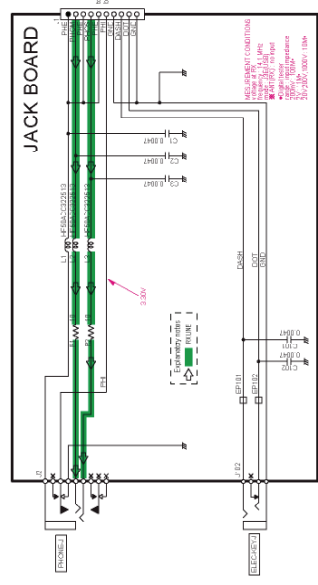

11-16 LOGIC UNIT AND MEMORY BOARD

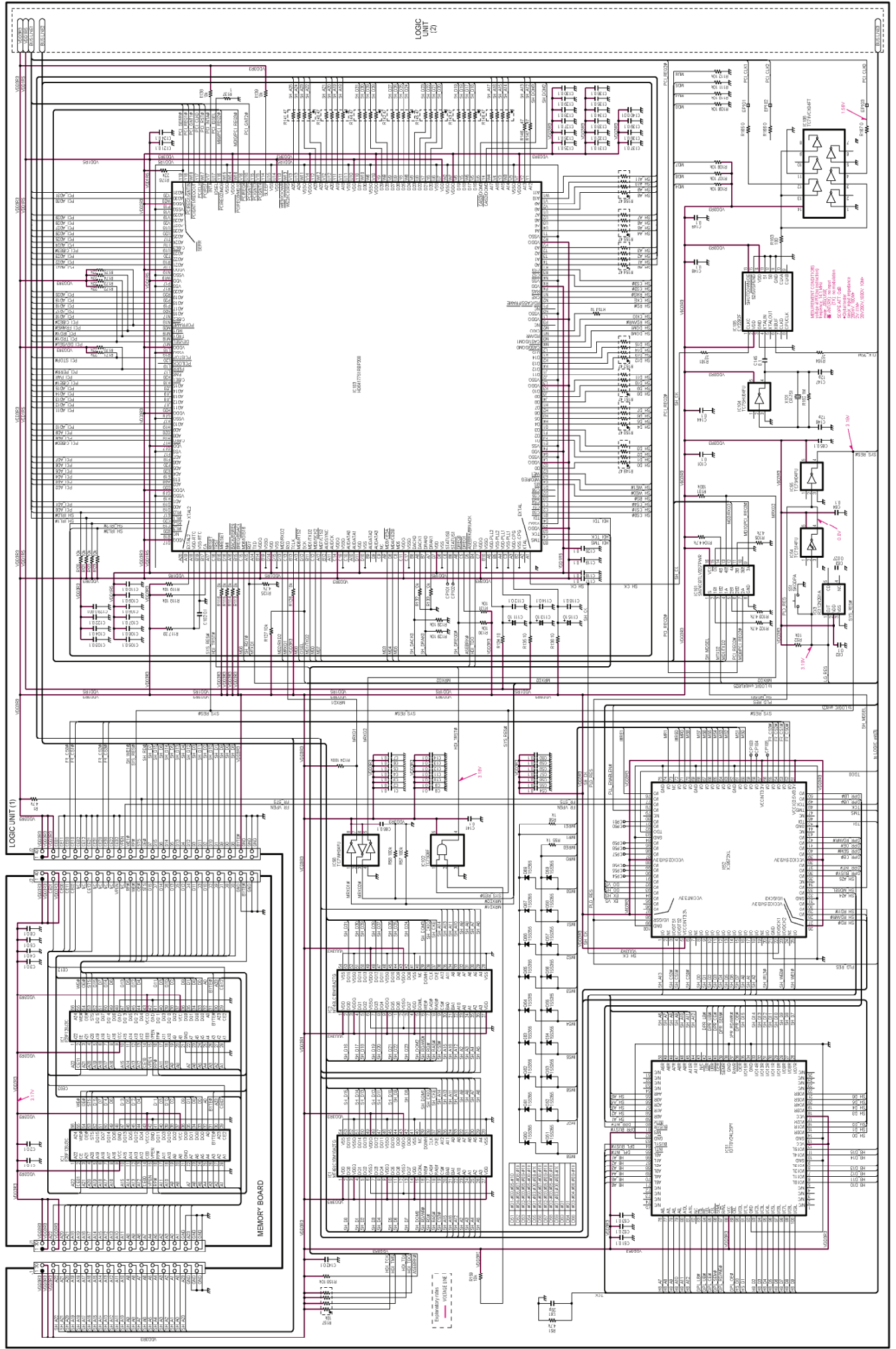

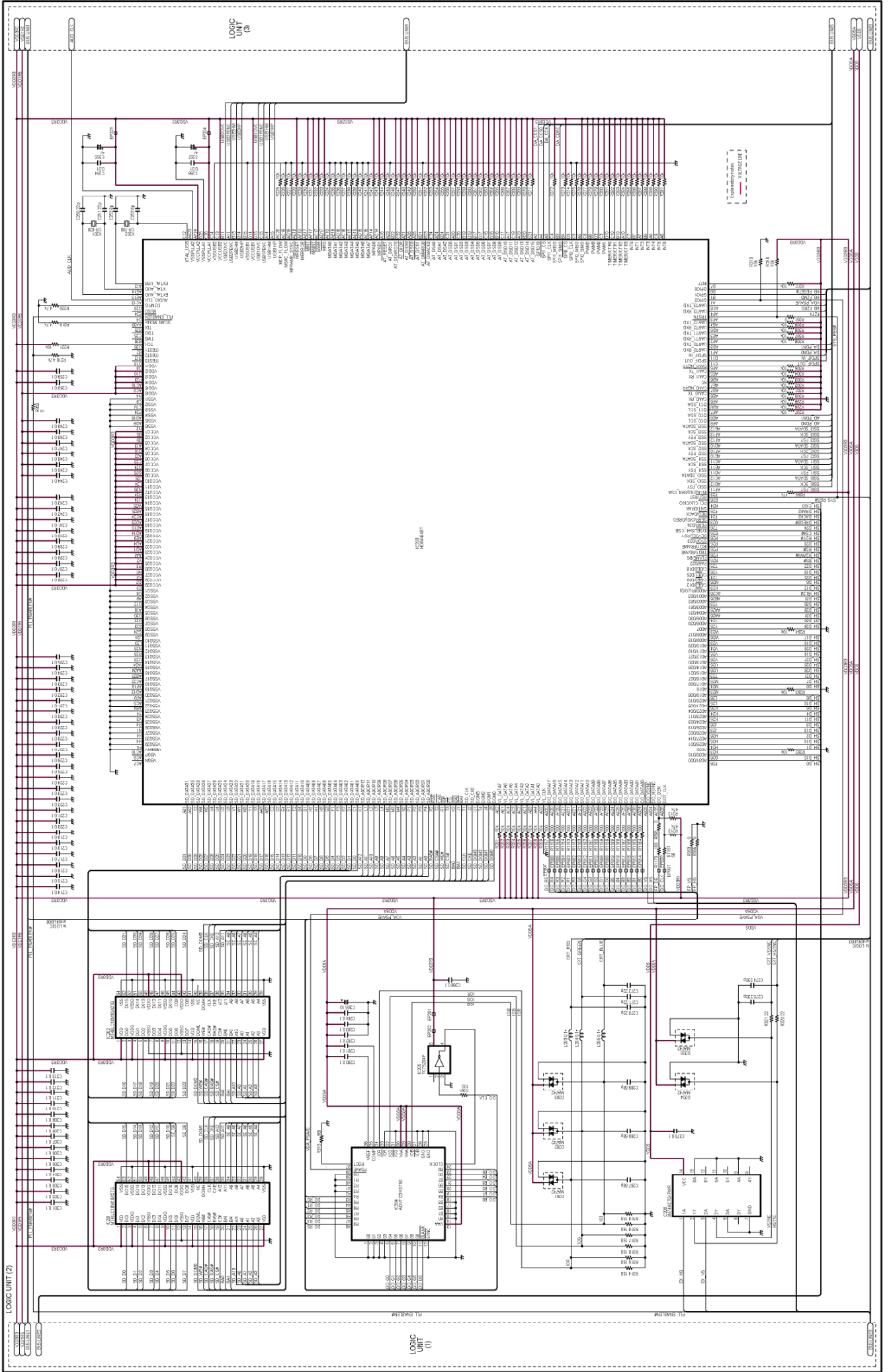

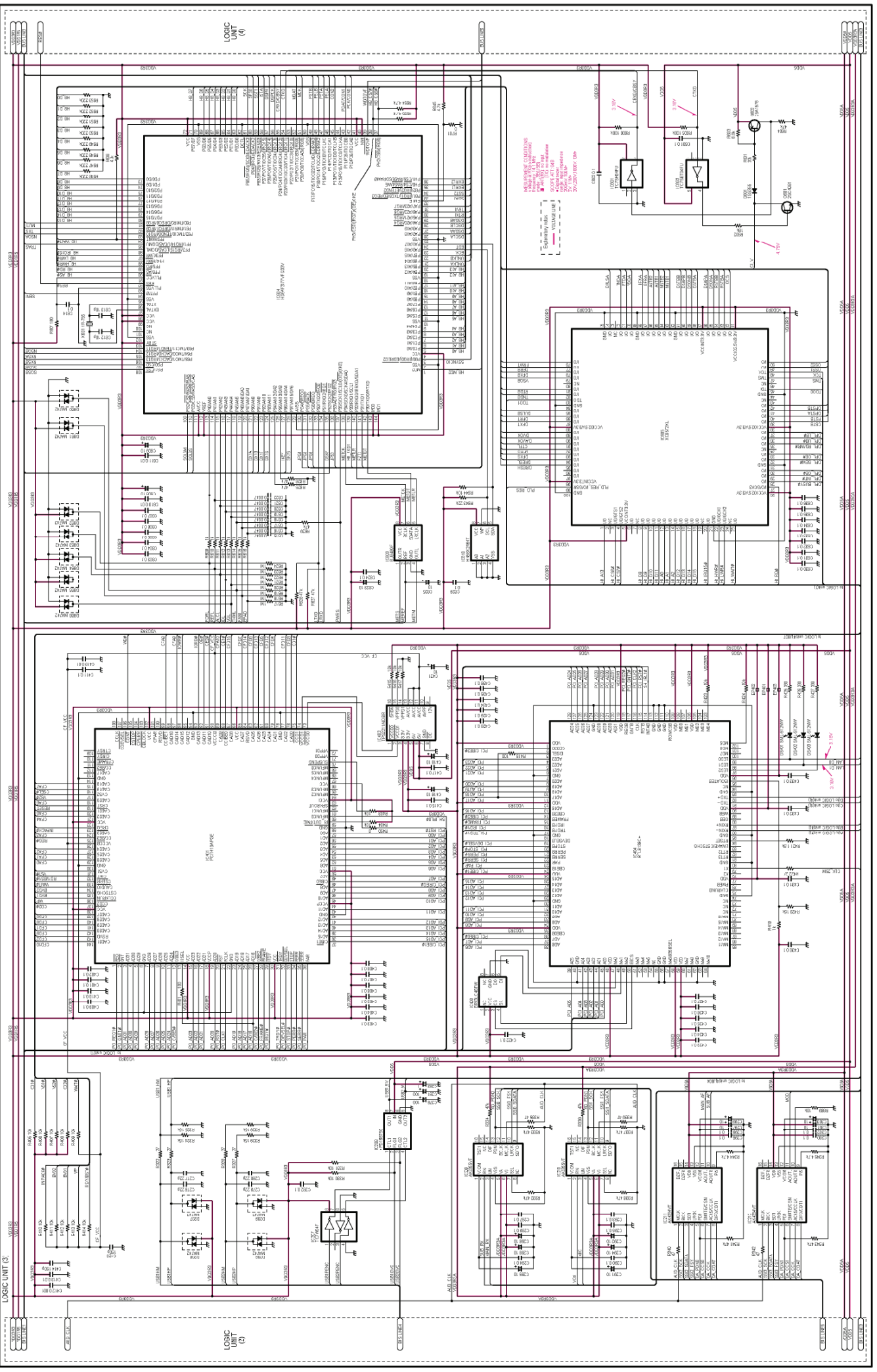

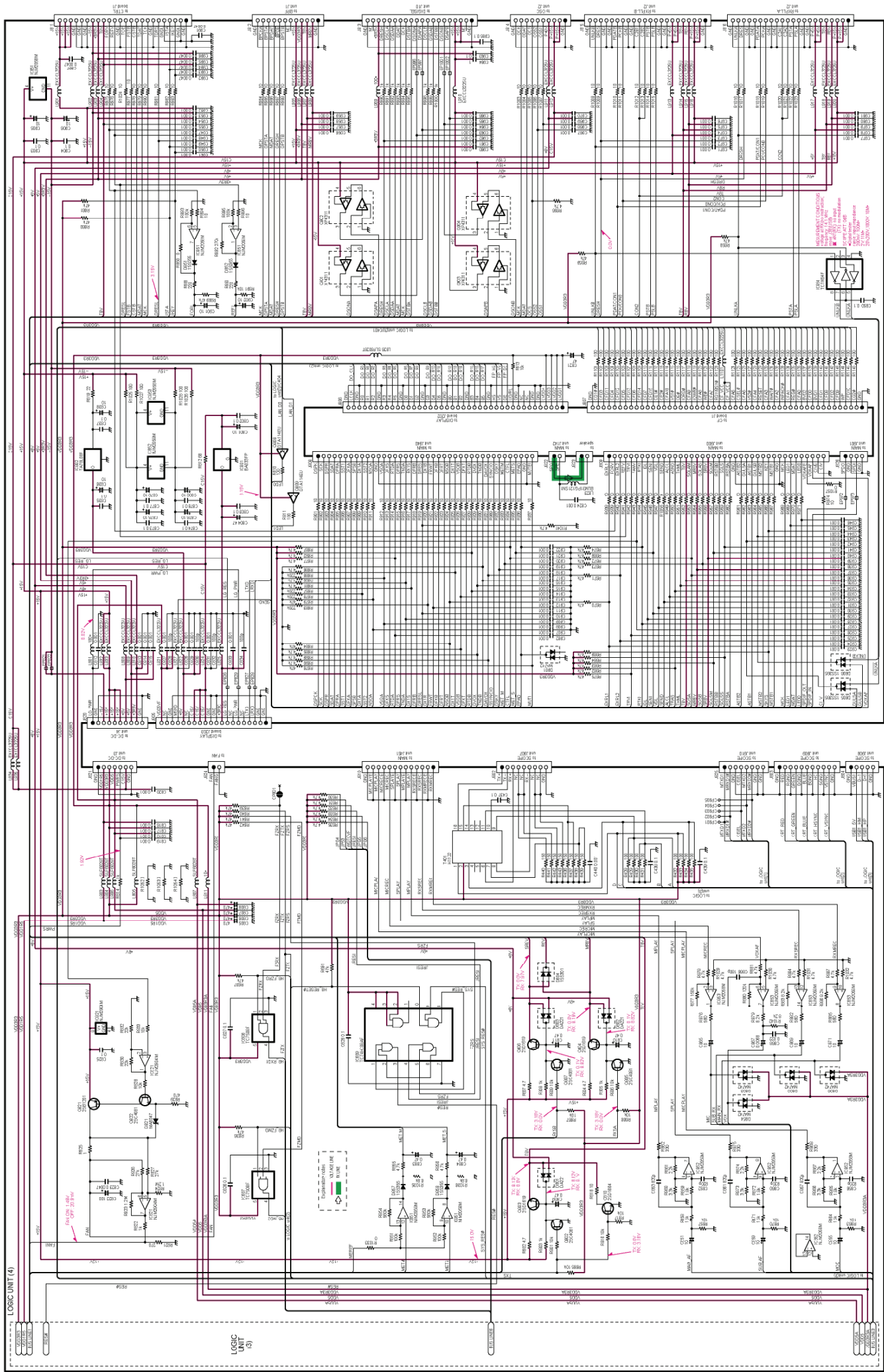

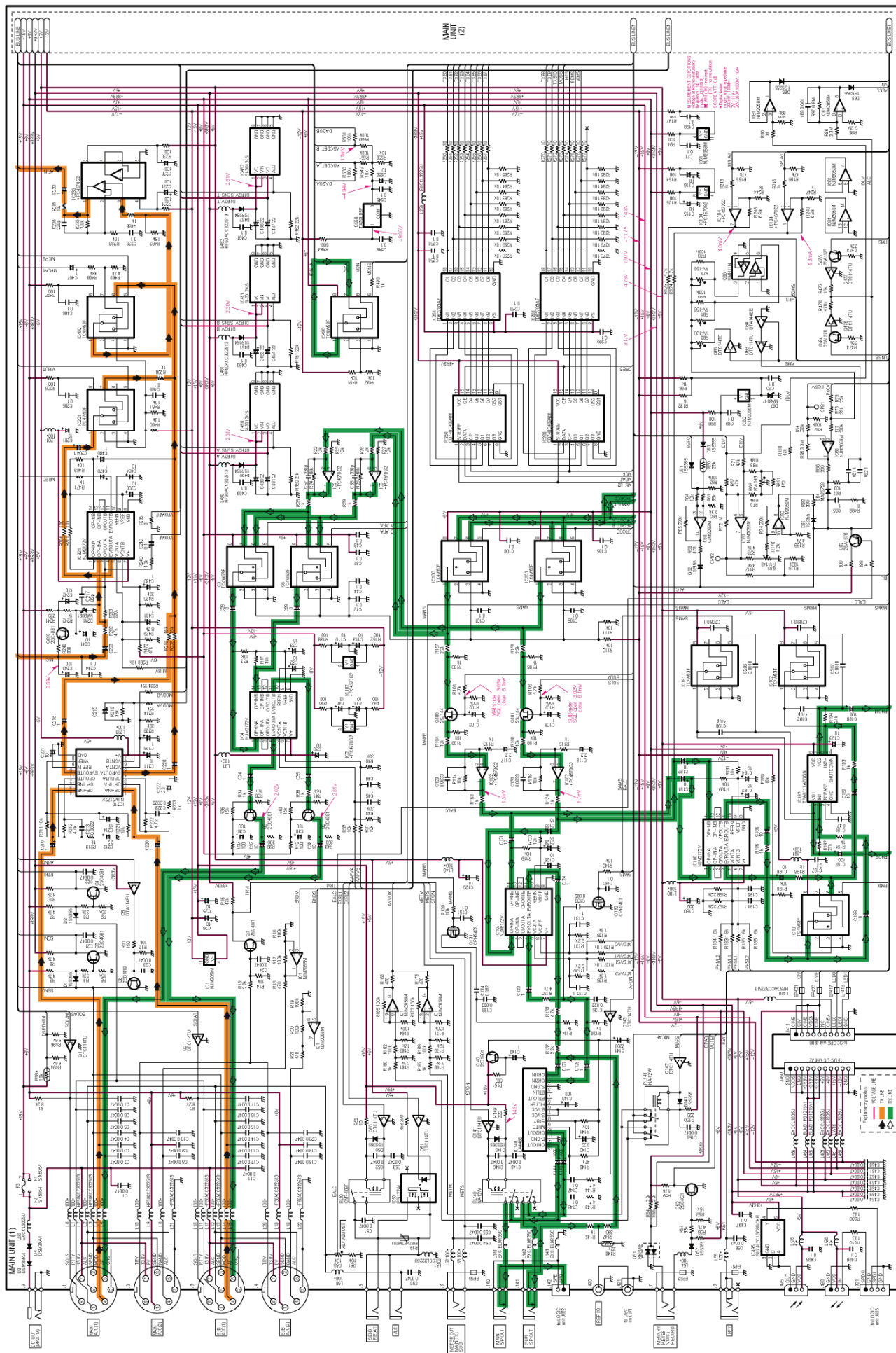

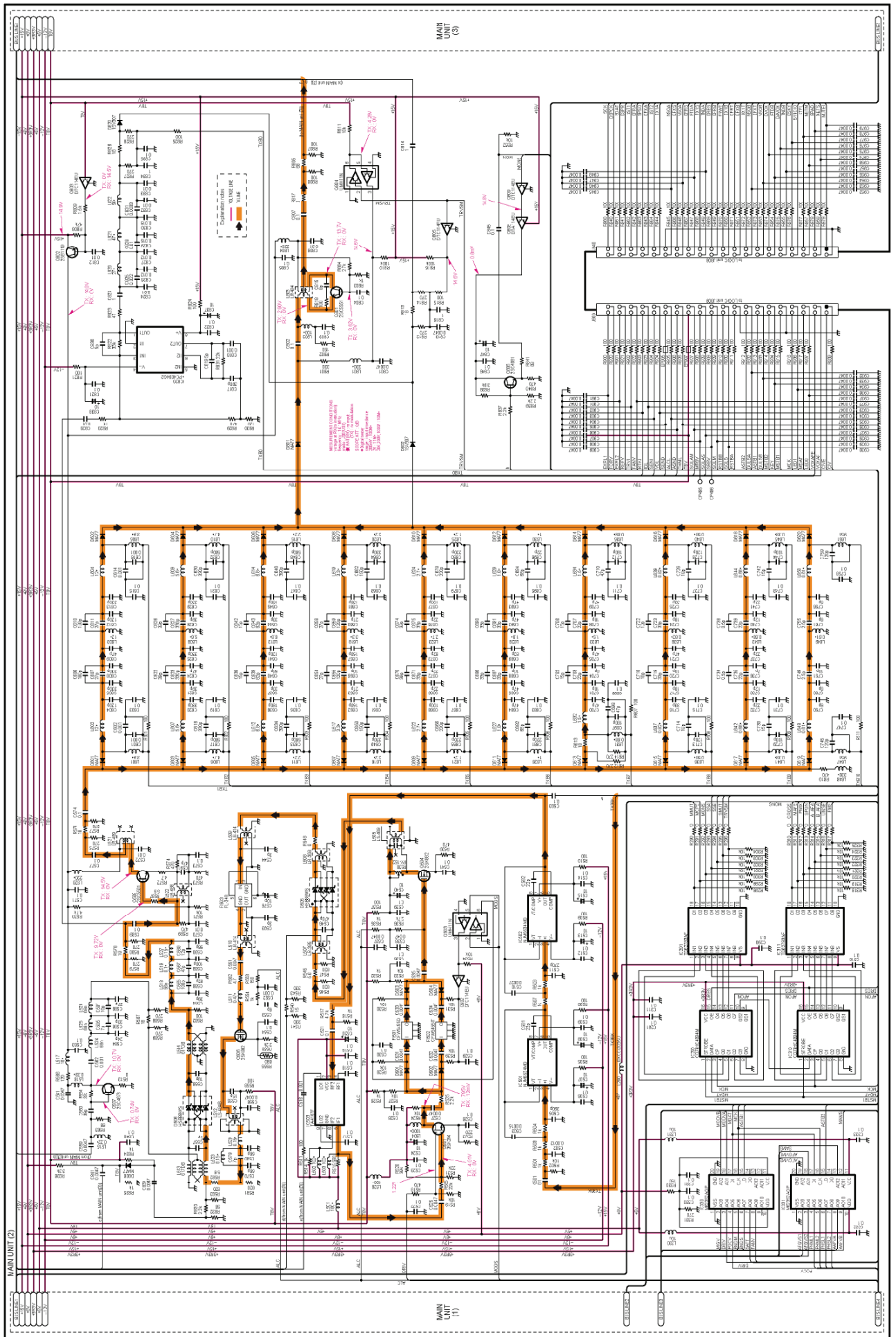

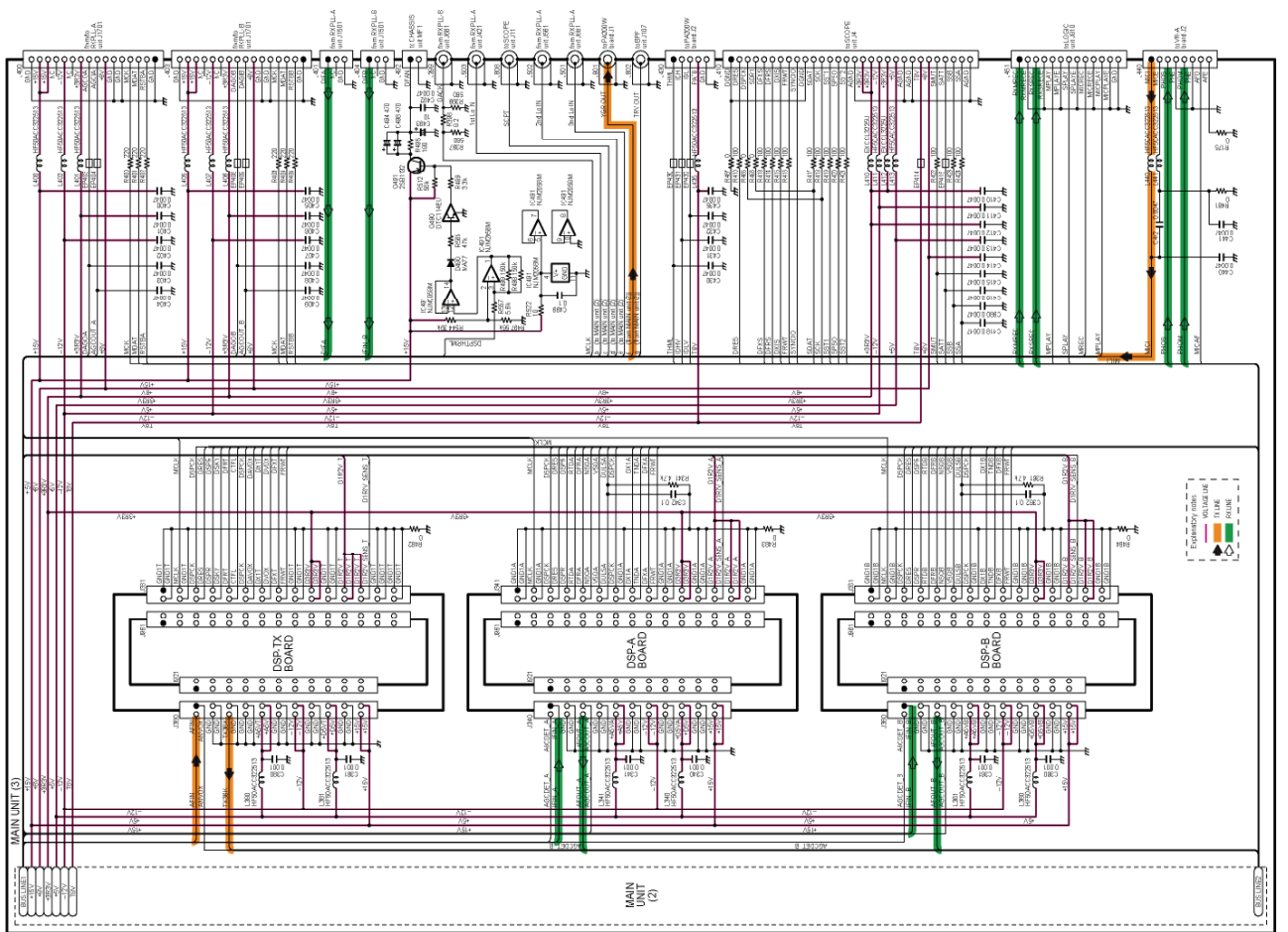

11-18 DSP-A/DSP-B BOARDS

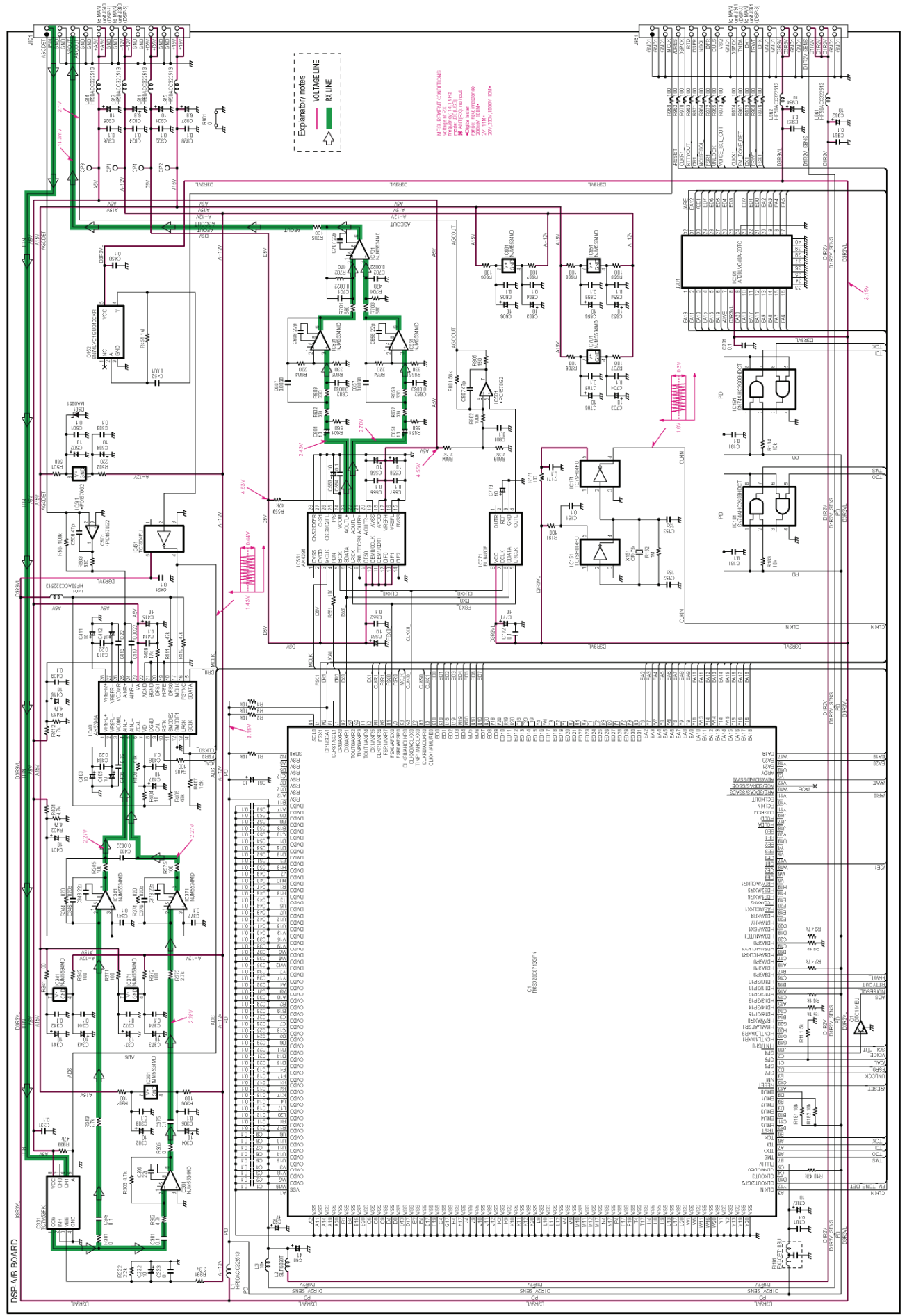

11-19 DSP-TX BOARD

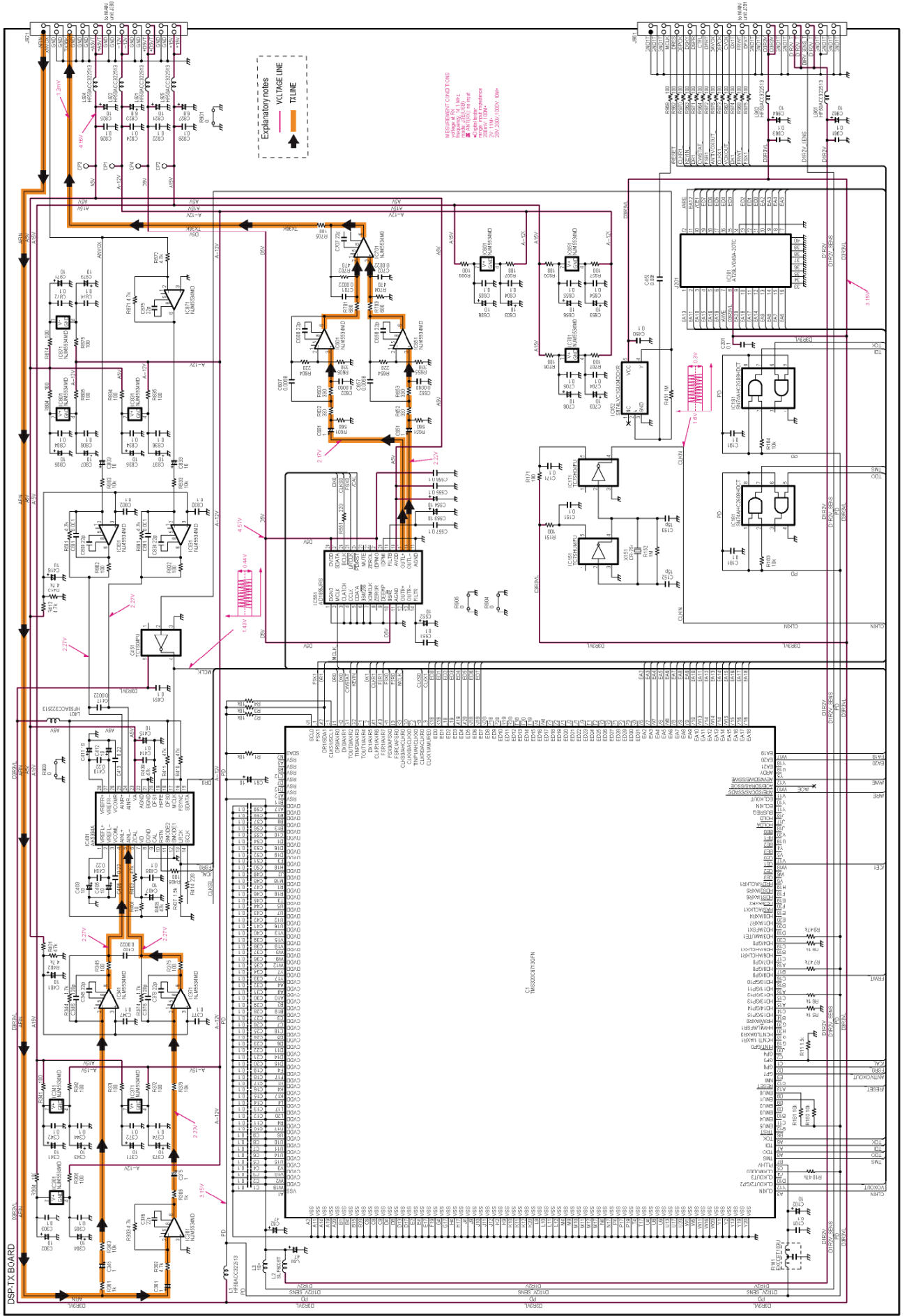

11-20 SCOPE UNIT

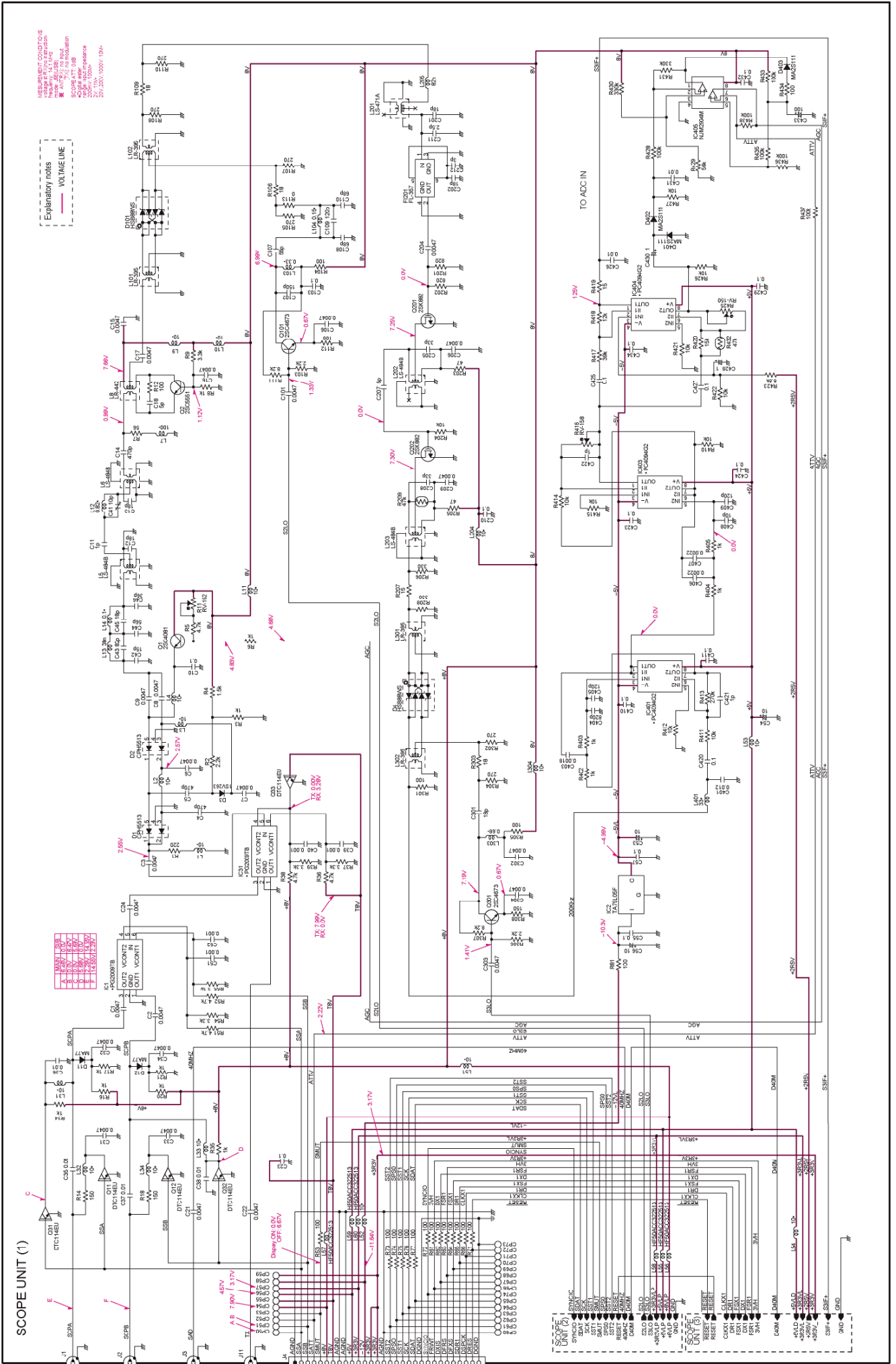

SCOPE UNIT (2)

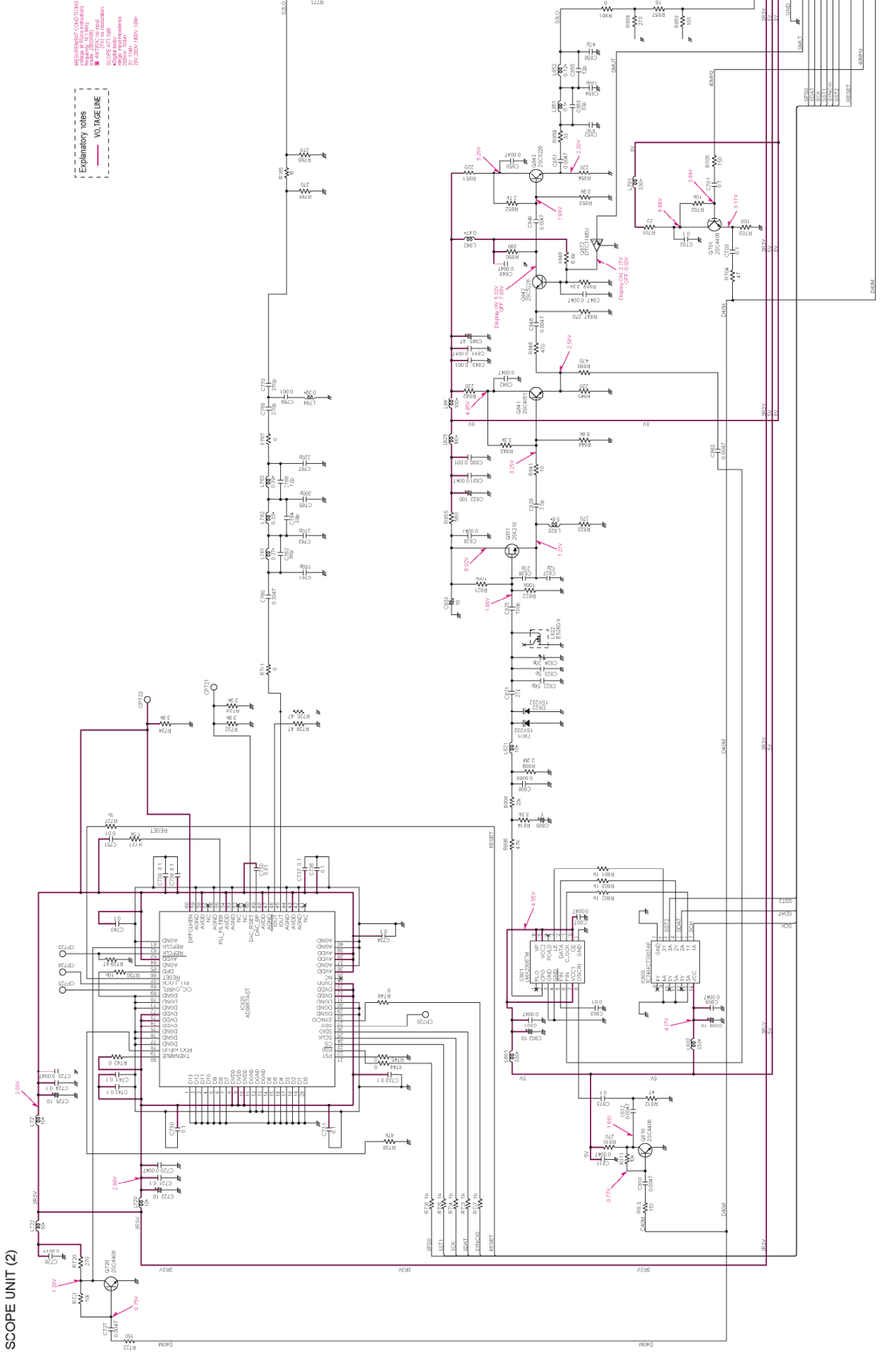

MEASUREMENT CONDITIONS:
- Input signal: 100mV, 100ns
- Voltage divider: 10:1
- Scope ATTEN: 10x
- Input impedance: 1MΩ
- Bandwidth: 200MHz

Explanatory notes:
- VO, TAGE LINE

SCOPE UNIT (1)

SCOPE UNIT (3)

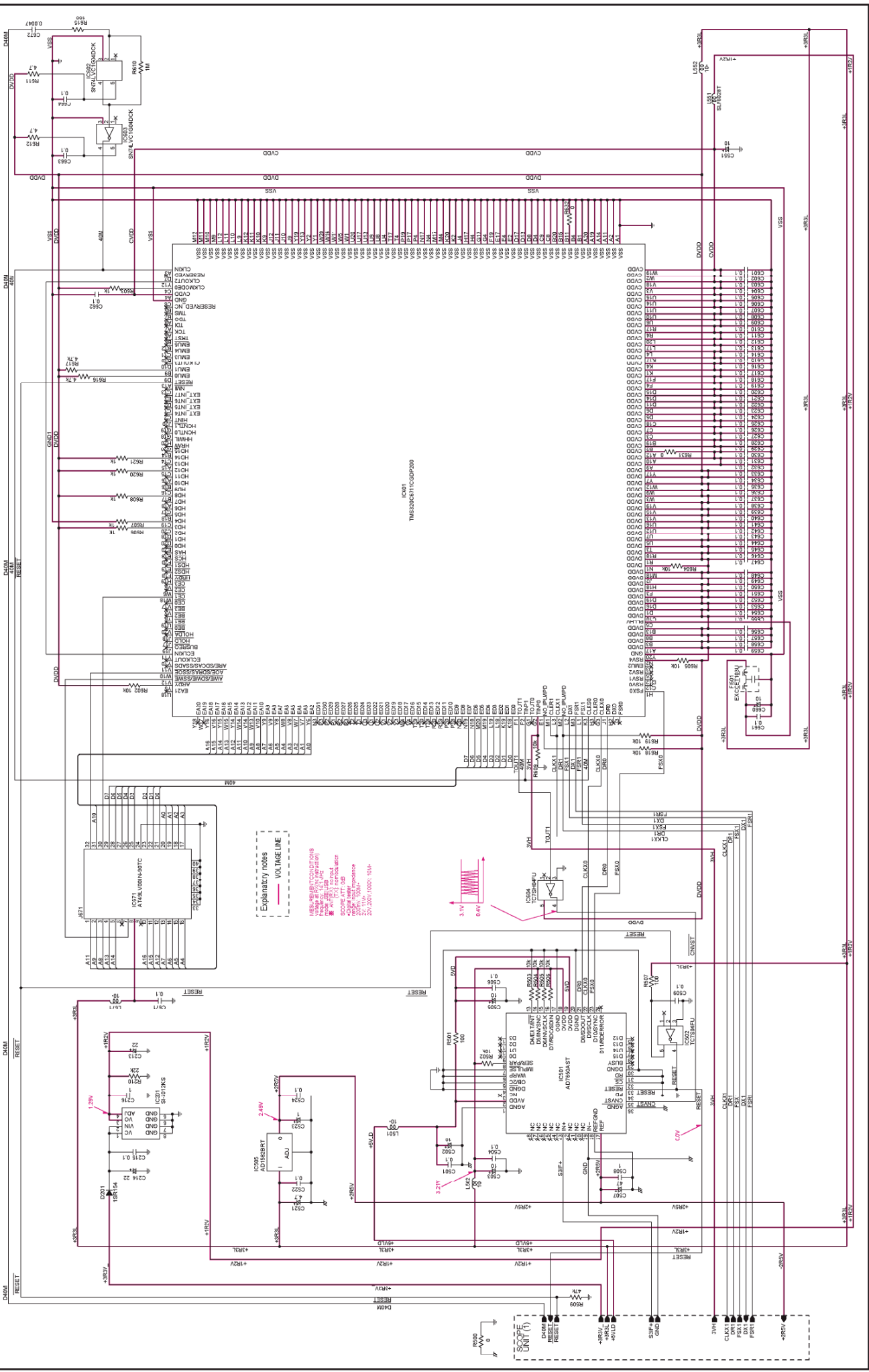

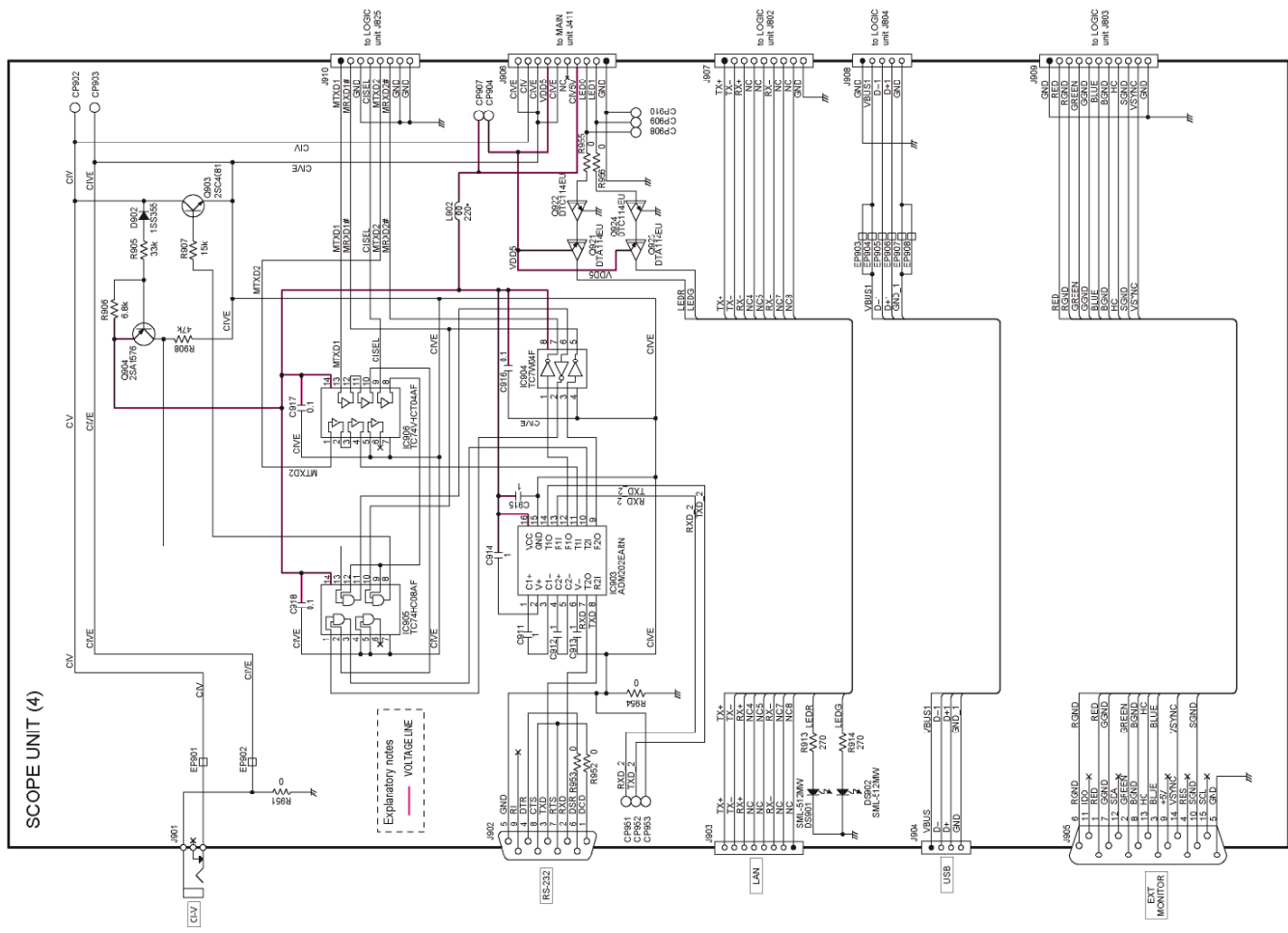

SCOPE UNIT (4)

Explanatory notes
 VOLTAGE LINE

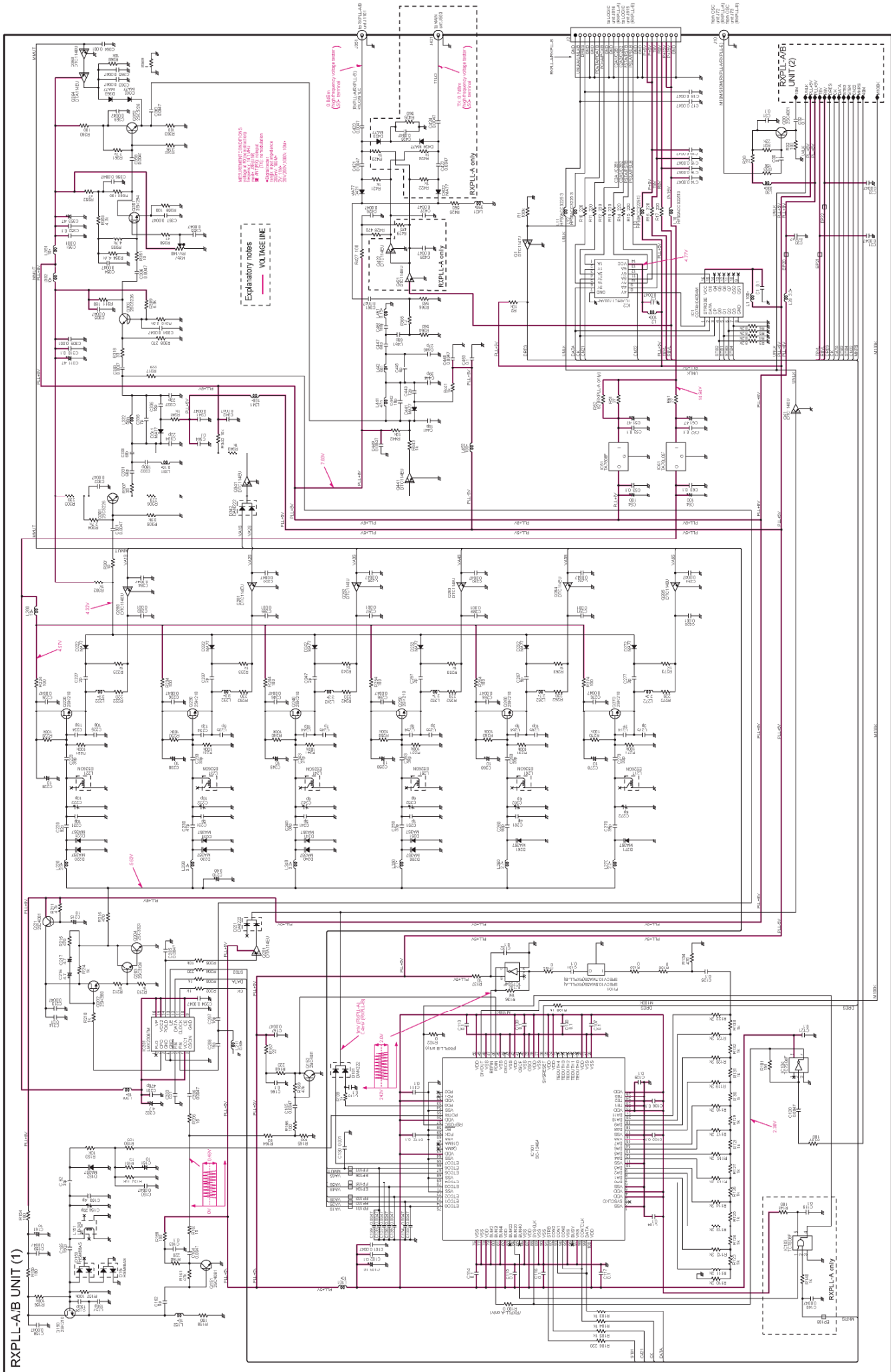

RXPLL-A/B UNIT (2)

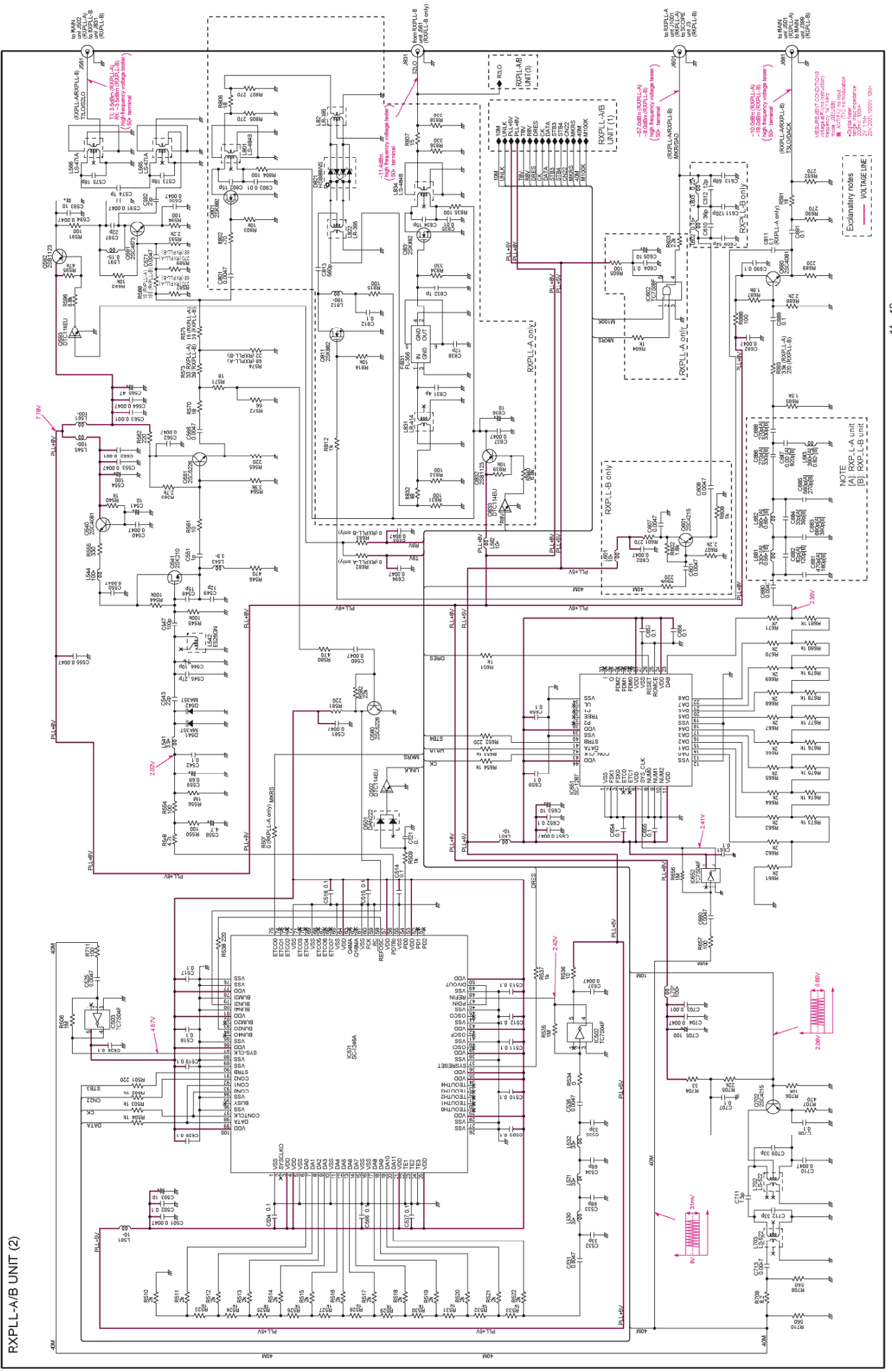

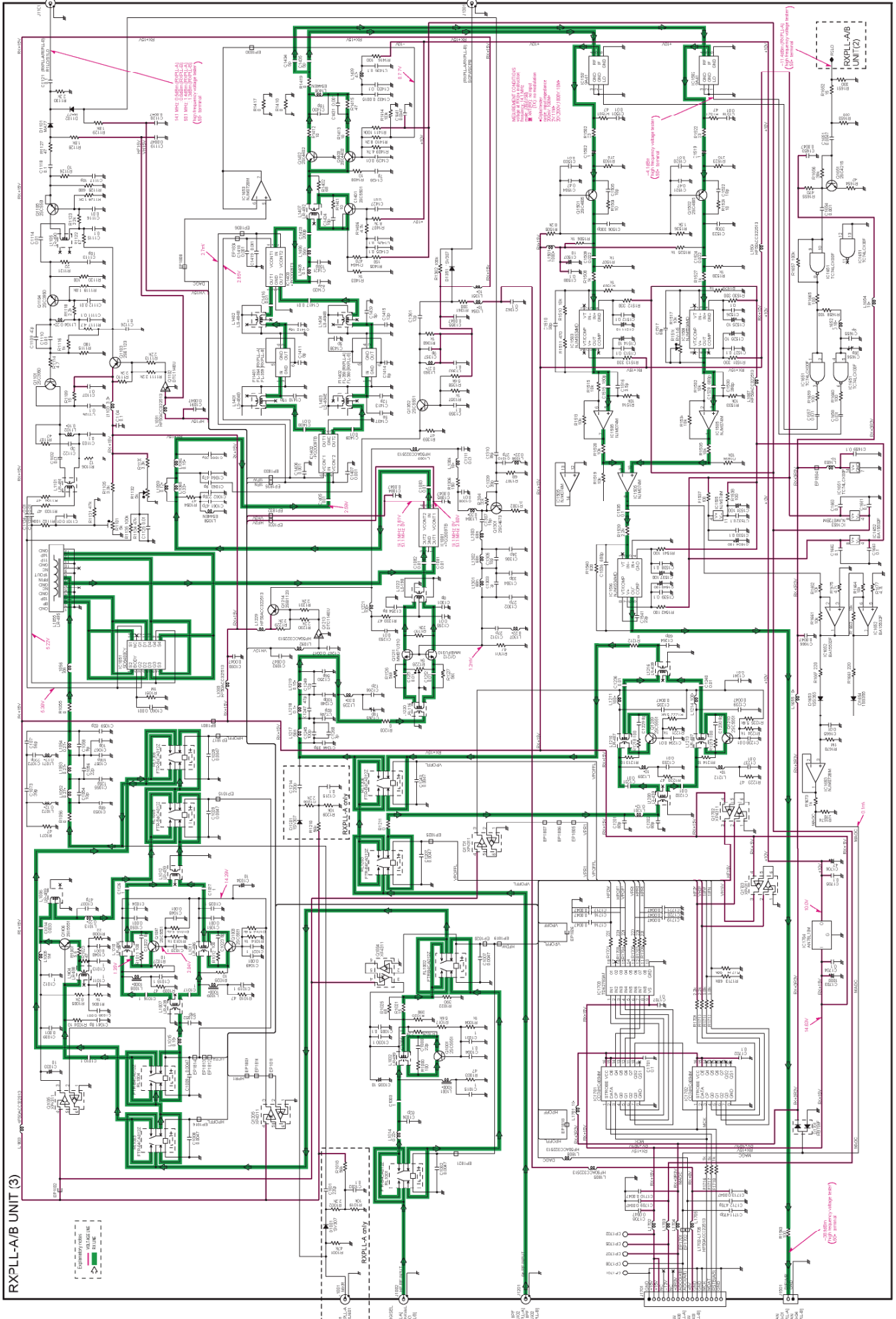

RXPLL-A/B UNIT (3)

EXPERIMENTAL WORK
 (Dashed box)

14.1 MHz (300MHz RXPLL-A/B)
 (200mV primary voltage base)

MEASUREMENT CONDITIONS
 TEMPERATURE: 20.000 / 100.0 / 100.0

14.1 MHz (300MHz RXPLL-A/B)
 (200mV primary voltage base)

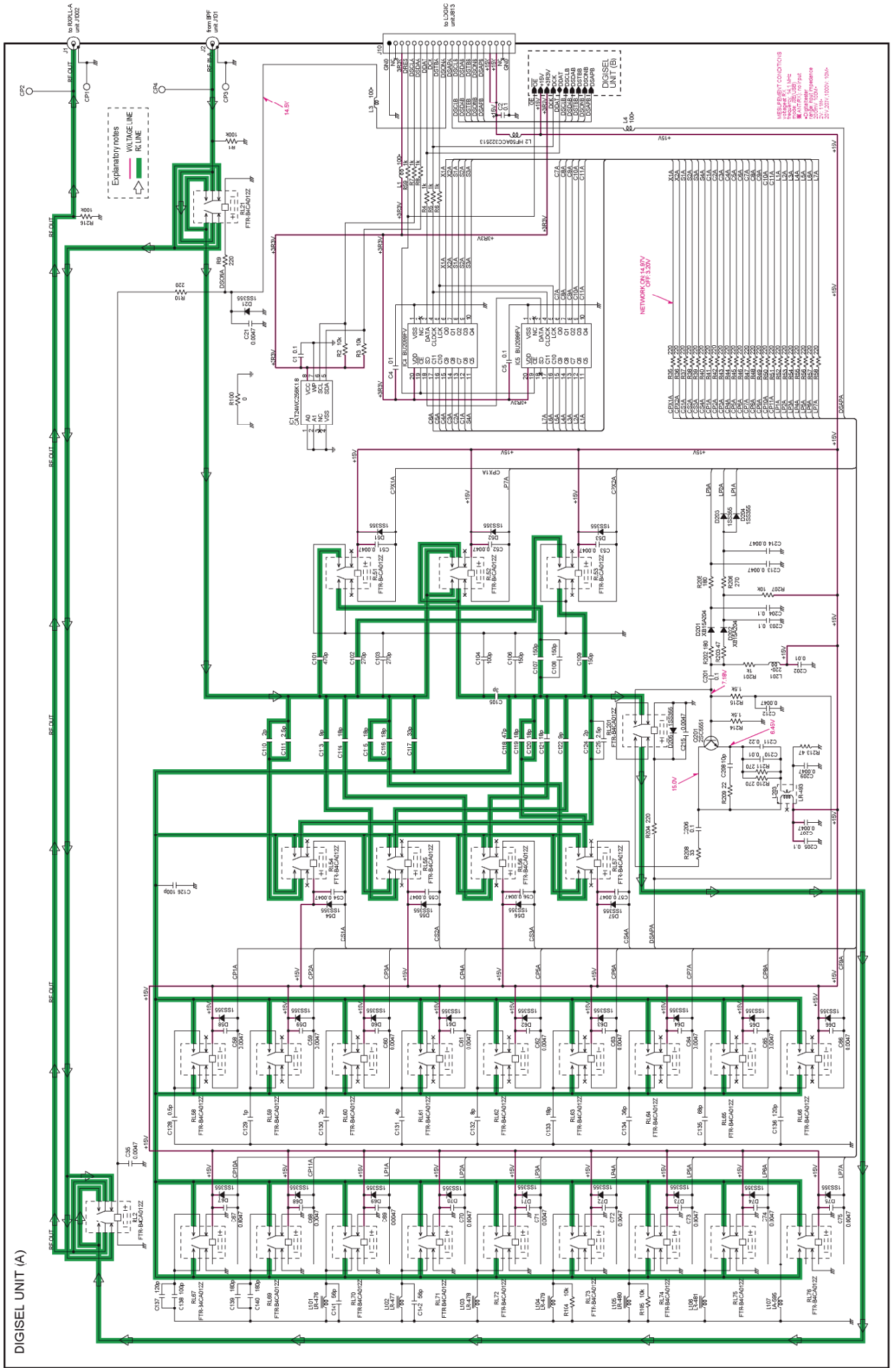

DIGISEL UNIT (B)

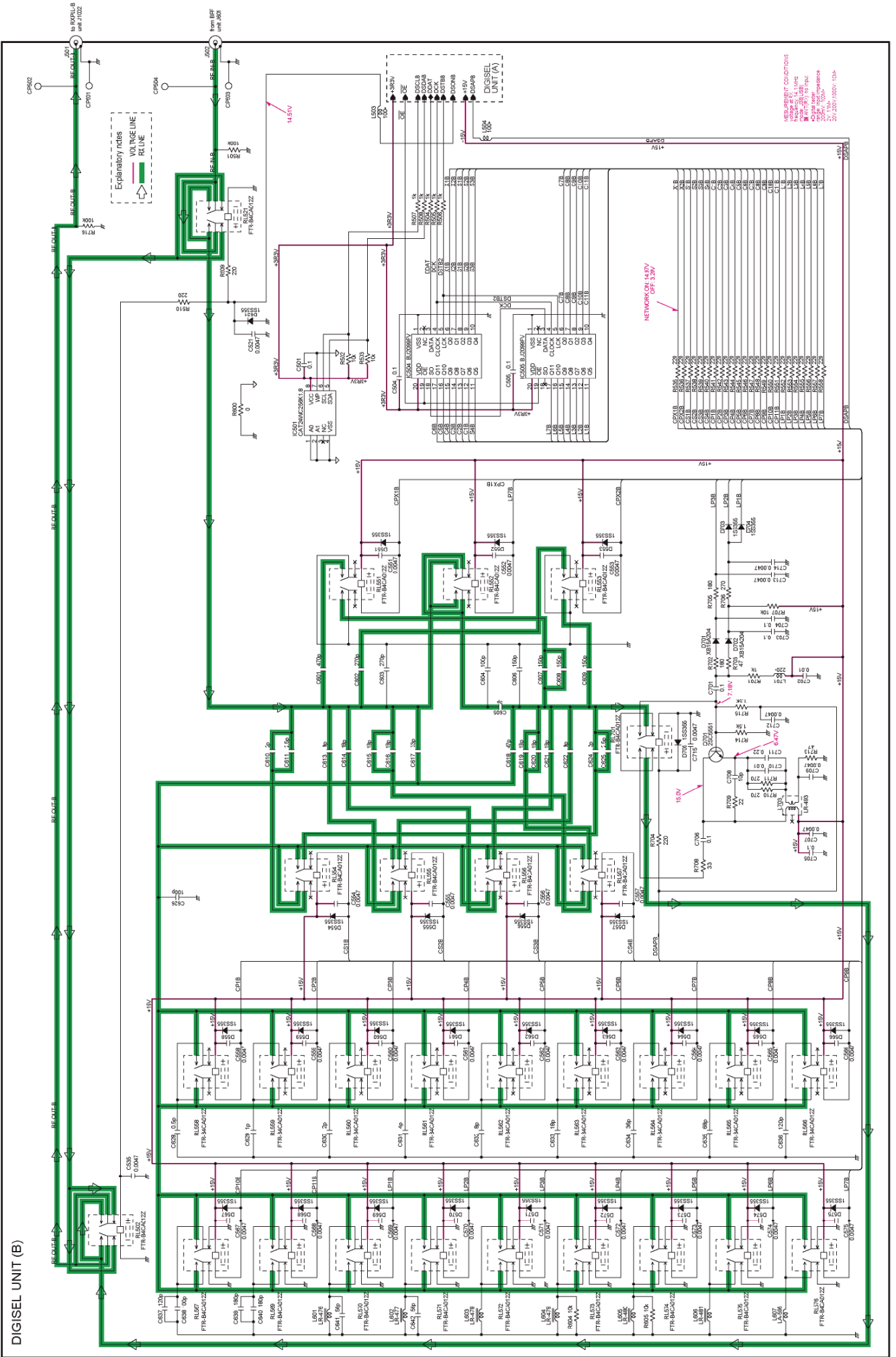

11-23 OSC UNIT

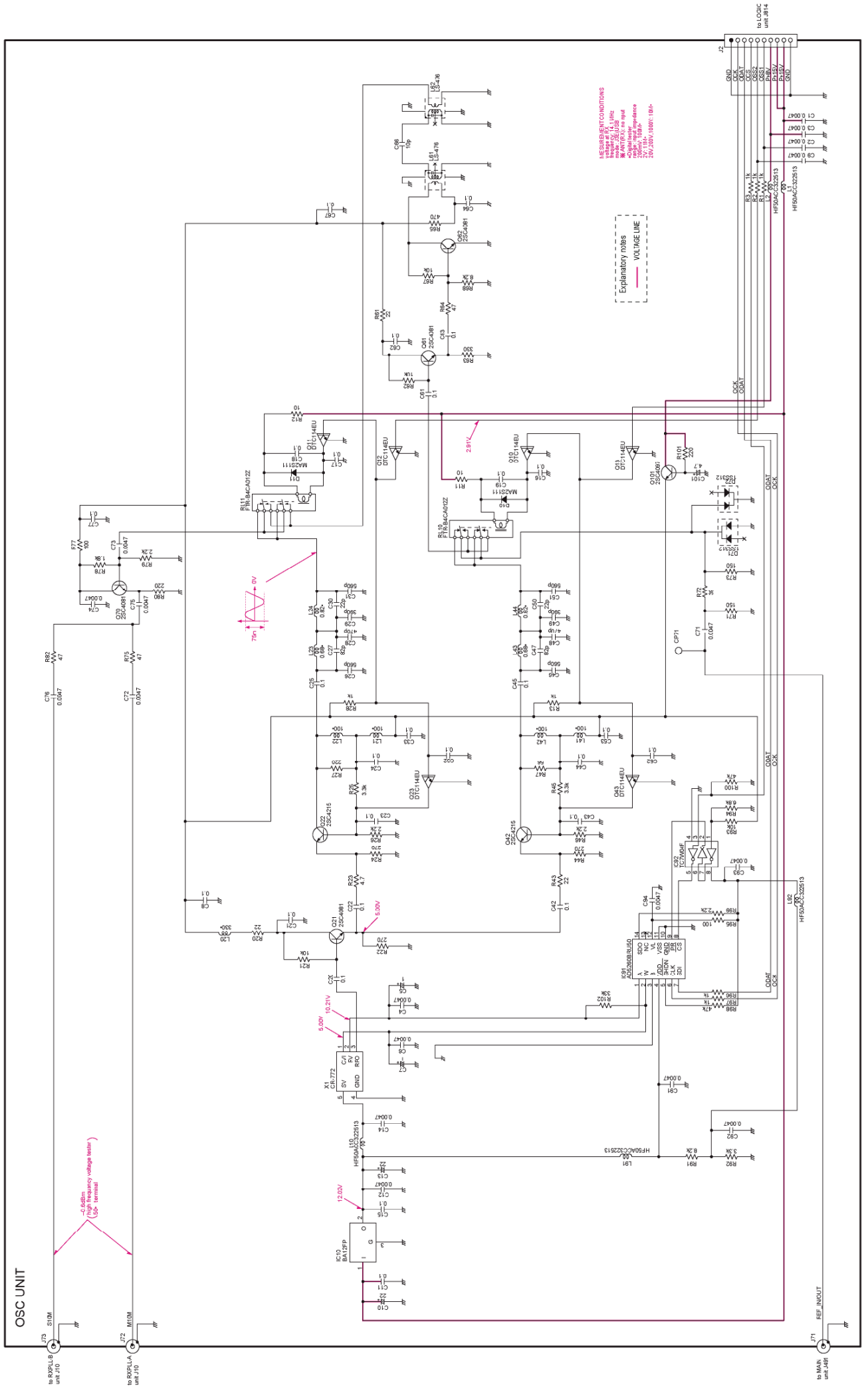

11-25 FILTER UNIT

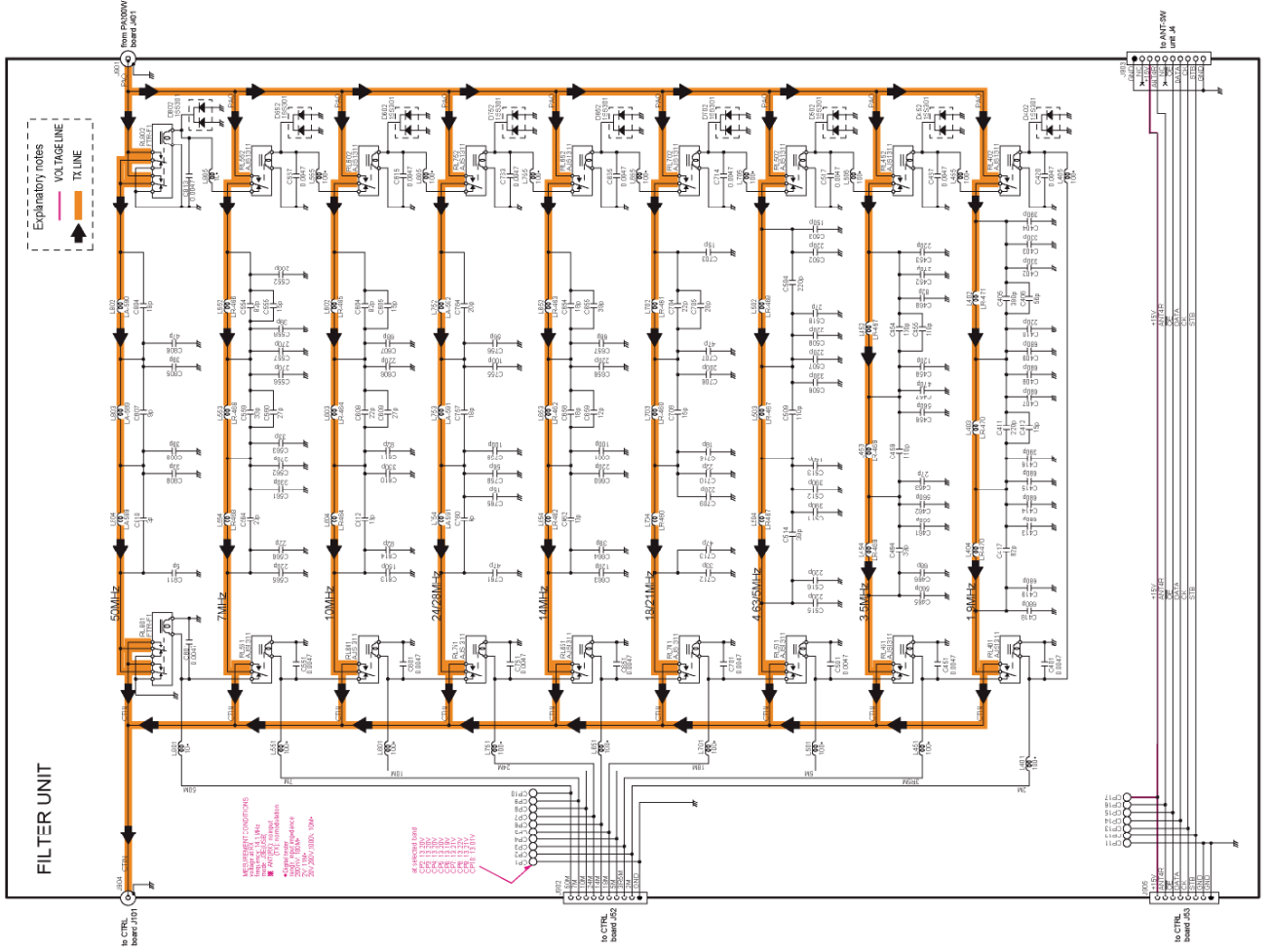

11-24 ANT-SW UNIT

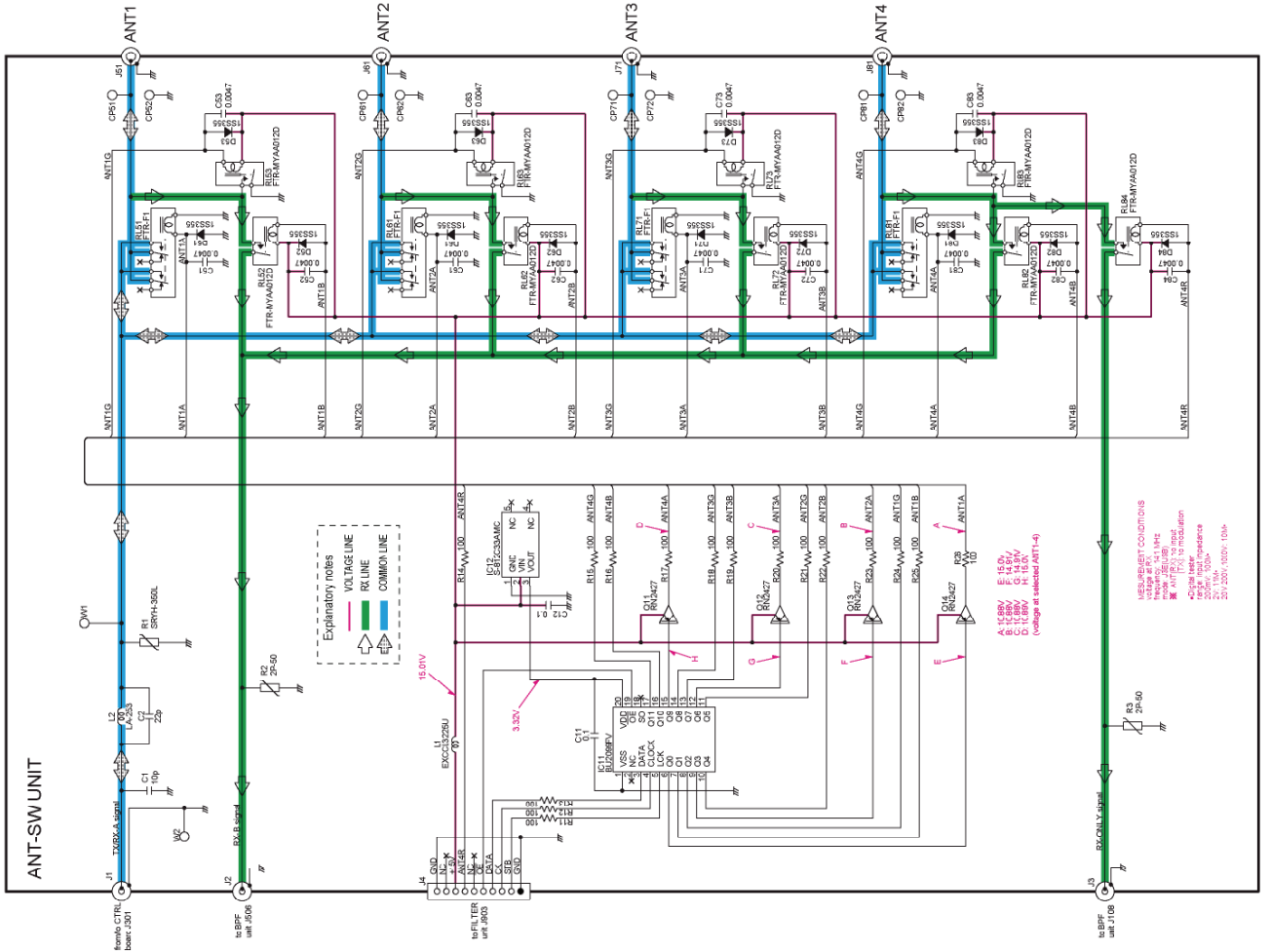

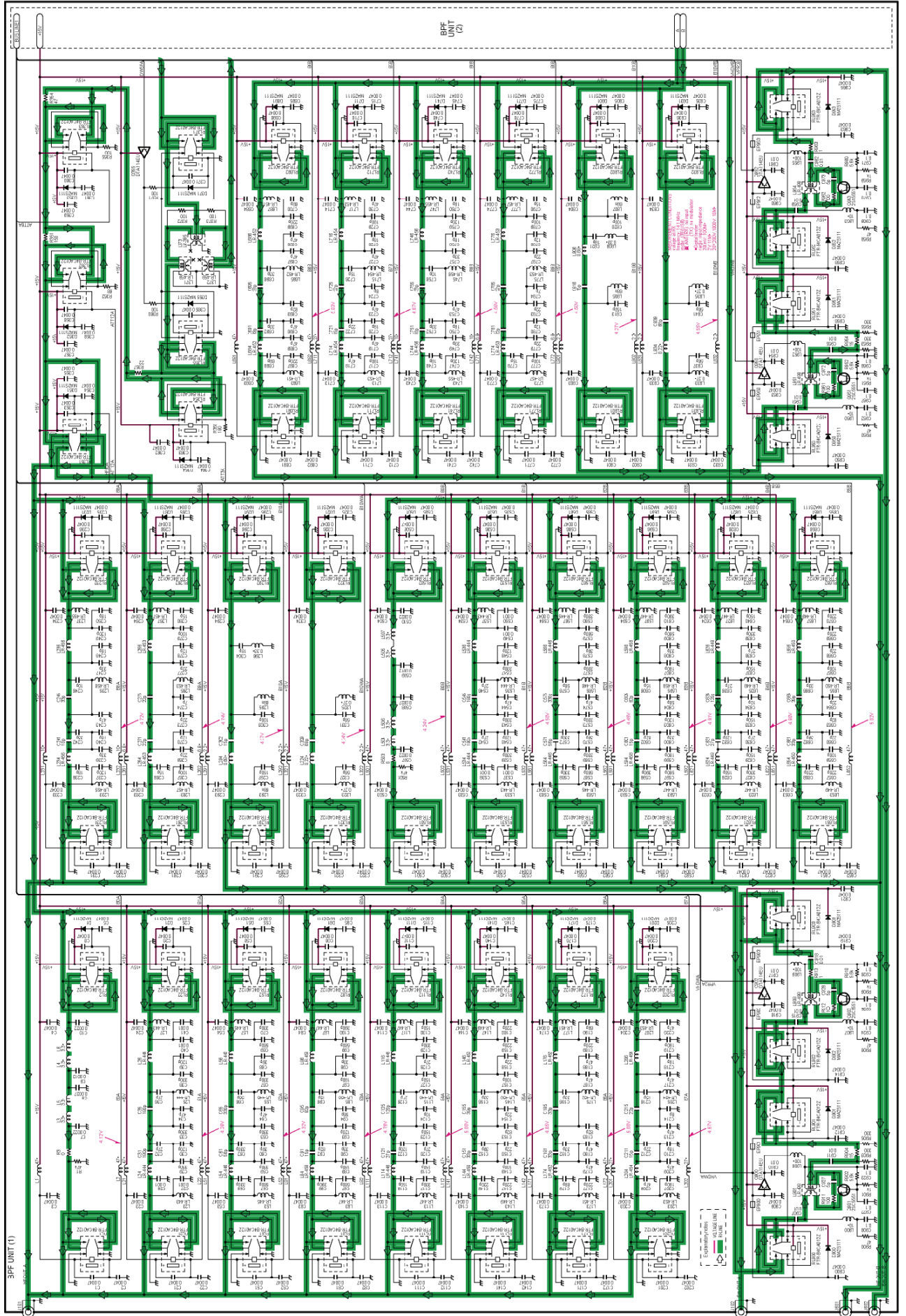

11-27 NETWORK BOARD

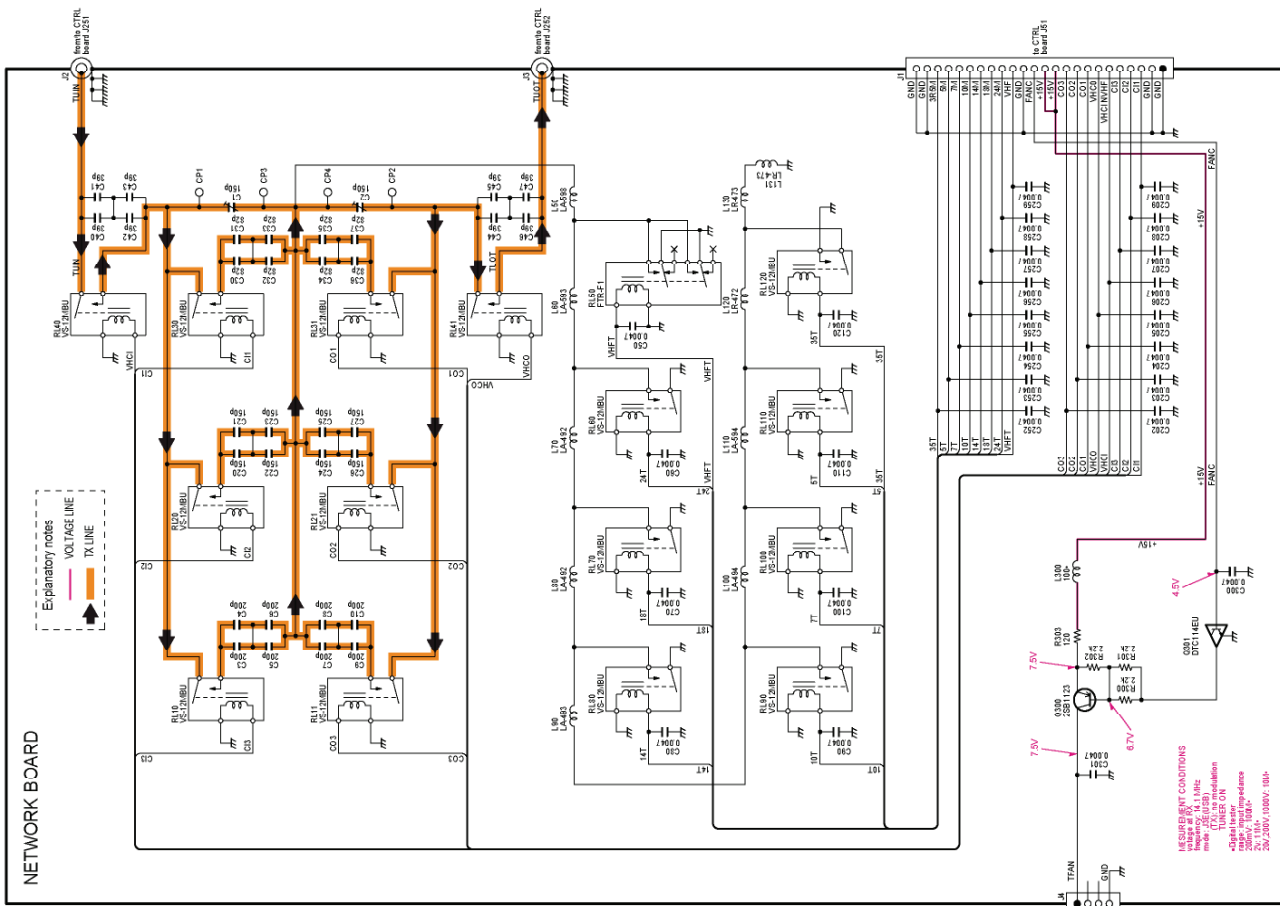
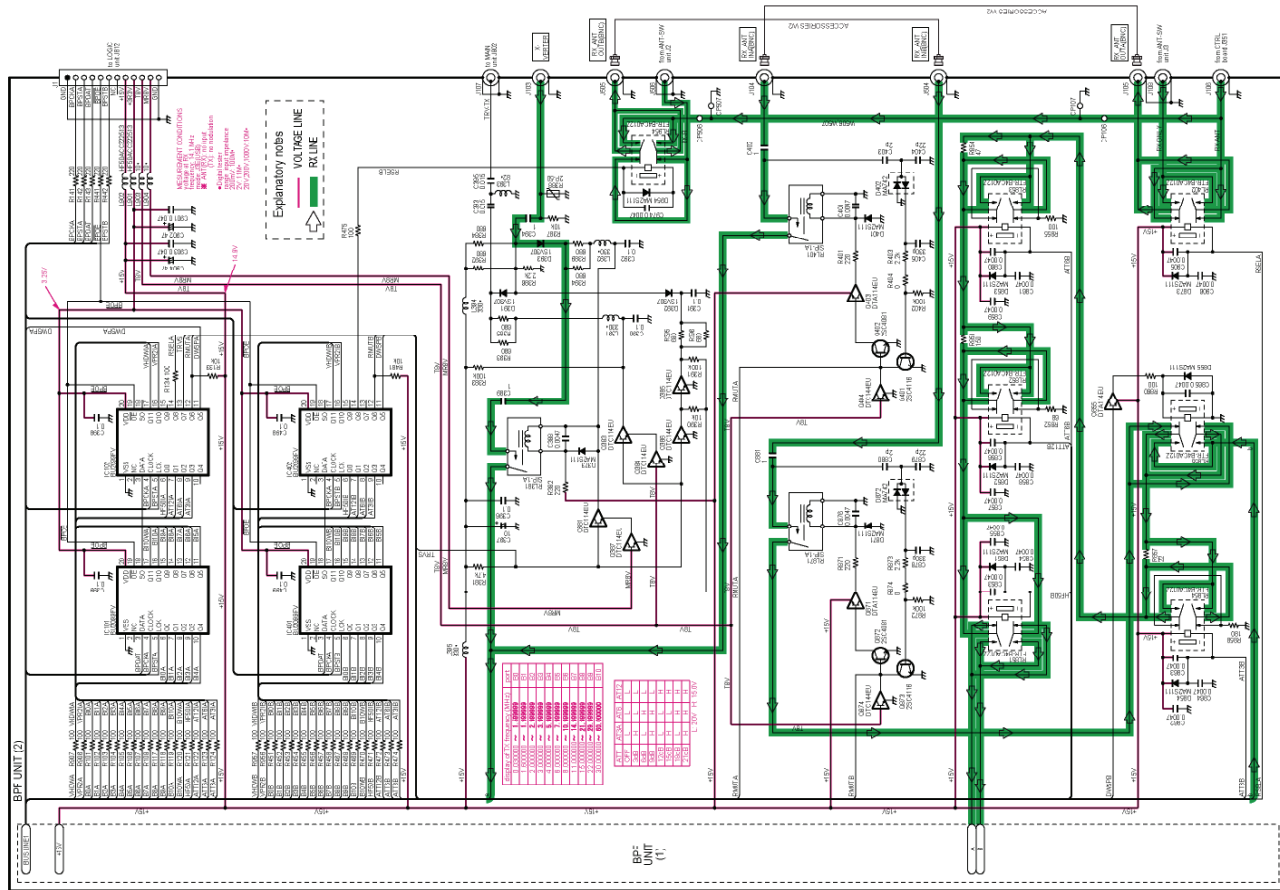

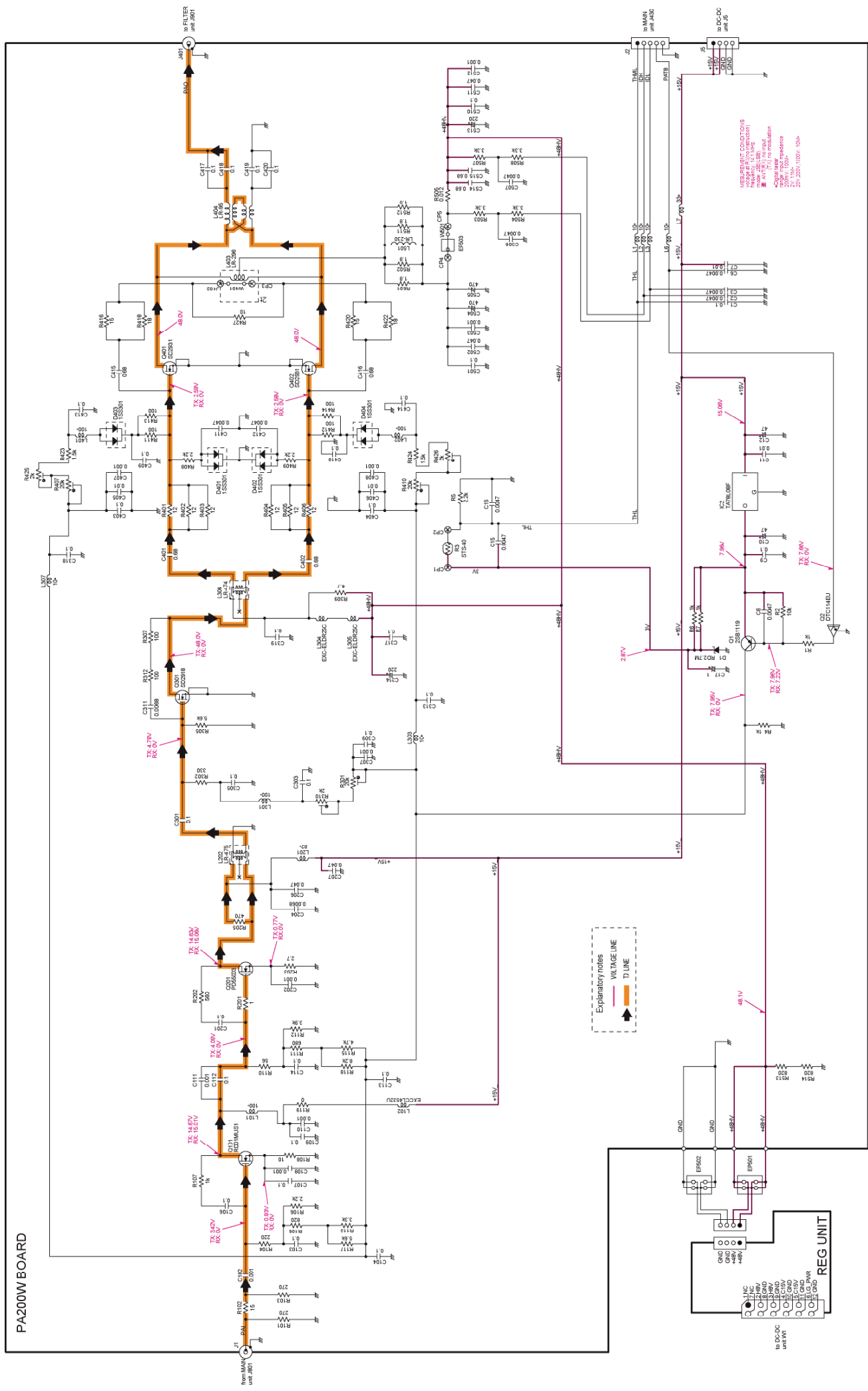

11-30 DC-DC UNIT

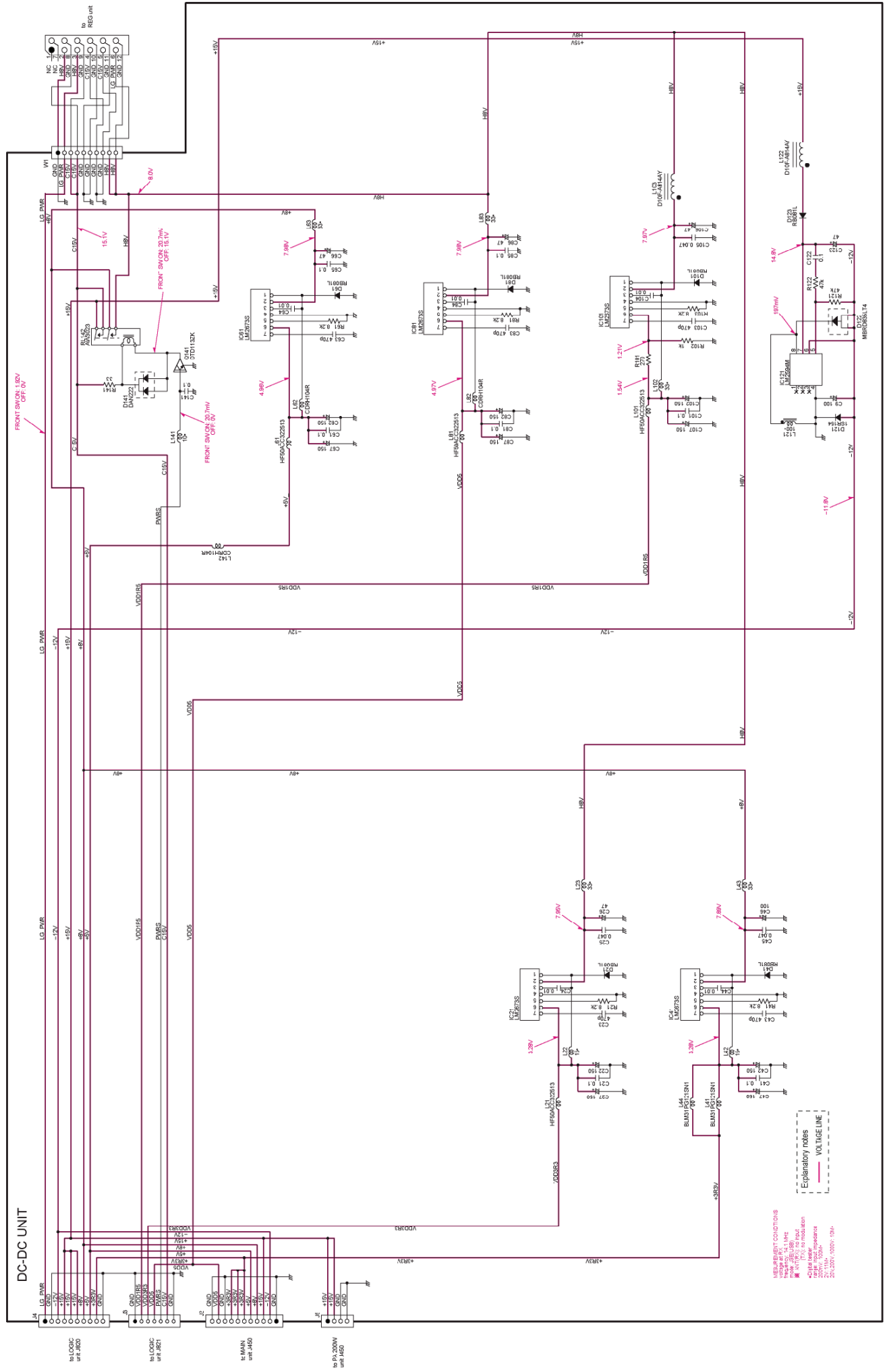

Icom Inc.

1-1-32, Kamiminami, Hirano-ku, Osaka 547-0003, Japan

Phone : +81 (06) 6793 5302

Fax : +81 (06) 6793 0013

URL : <http://www.icom.co.jp/world/index.html>

Icom America Inc.

<Corporate Headquarters>
2380 116th Avenue N.E., Bellevue, WA 98004, U.S.A.
Phone : +1 (425) 454-8155 Fax : +1 (425) 454-1509
URL : <http://www.icomamerica.com>
<Customer Service>
Phone : +1 (425) 454-7619

Icom Canada

Glenwood Centre #150-6165
Highway 17 Delta, B.C., V4K 5B8, Canada
Phone : +1 (604) 952-4266 Fax : +1 (604) 952-0090
URL : <http://www.icomcanada.com>

Icom (Australia) Pty. Ltd.

A.B.N. 88 006 092 575
290-294 Albert Street, Brunswick, Victoria, 3056, Australia
Phone : +61 (03) 9387 0666 Fax : +61 (03) 9387 0022
URL : <http://www.icom.net.au>

Icom New Zealand

146A Harris Road, East Tamaki,
Auckland, New Zealand
Phone : +64 (09) 274 4062 Fax : +64 (09) 274 4708
URL : <http://www.icom.co.nz>

Beijing Icom Ltd.

1305, Wanshang Plaza, Shijingshan Road, Beijing China
Phone : +86 (010) 6866 6337 Fax : +86 (010) 6866 3553
URL : <http://www.bjicom.com>

Icom (Europe) GmbH

Communication Equipment
Himmelgeister Str. 100, D-40225 Düsseldorf, Germany
Phone : +49 (0211) 346047 Fax : +49 (0211) 333639
URL : <http://www.icomeurope.com>

Icom Spain S.L

Crta. de Gracia a Manresa Km. 14,750
08190 Sant Cugat del Valles Barcelona, SPAIN
Phone : +34 (93) 590 26 70 Fax : +34 (93) 589 04 46
URL : <http://www.icomspain.com>

Icom (UK) Ltd.

Unit 9, Sea St., Heme Bay, Kent, CT8 8LD, U.K.
Phone : +44 (01227) 741741 Fax : +44 (01227) 741742
URL : <http://www.icomuk.co.uk>

Icom France S.a

Zac de la Plaine, 1, Rue Brindejonc des Moulinails
BP 5804, 31505 Toulouse Cedex, France
Phone : +33 (5) 61 36 03 03 Fax : +33 (5) 61 36 03 00
URL : <http://www.icom-france.com>

Asia Icom Inc.

6F No. 68, Sec. 1 Cheng-Teh Road, Taipei, Taiwan, R.O.C.
Phone : +886 (02) 2559 1899 Fax : +886 (02) 2559 1874
URL : <http://www.asia-icom.com>

Count on us!

Icom Inc.

1-1-32, Kamiminami, Hirano-ku, Osaka 547-0003, Japan

S-14015HZ-C1
© 2004 Icom Inc.