

# OPERATING MANUAL

## FT-211RH



**YAESU MUSEN CO., LTD.**  
**C.P.O. BOX 1500**  
**TOKYO, JAPAN**

## CONTENTS

Supplied Accessories, Options	2
SPECIFICATIONS . . . . .	3
CONTROLS & CONNECTORS . . . . .	4
Front Panel	4
Rear Panel	7
INSTALLATION . . . . .	8
Packet Radio TNC Interconnections	12
Modification (of B & D versions) for Packet Radio	12
FTS-12 Tone Squelch Unit Installation	14
Memory Cloning	15
OPERATION . . . . .	16
Preliminary Operating Information	16
Squelch Setup	16
Transmitting Procedure	17
Frequency & Step Selection	18
Memory Storage & Recall	18
Repeater Operation	20
Scanning	21
Priority Channel Monitoring	22
Tone Squelch Operation	23
IN CASE OF PROBLEMS . . . . .	24

## YAESU FT-211RH COMPACT SYNTHESIZED 2m FM MOBILE TRANSCEIVER

The FT-211RH is a compact synthesized FM mobile/base transceiver providing switch-selectable power output of either 5 or 45 watts on the 2m amateur band.

The reversible sloped front panel allows convenient overhead mounting, and includes soft green back-lighting of the keys and controls, and the large liquid crystal display (with bargraph PO/S-meter). Inside the FT-211RH, extensive use of chip components assures high circuit reliability, while modular circuit construction makes servicing easy.

Operating features copied from the popular FT-23R Handheld include both pushbutton and knob memory selection and tuning in selectable steps; ten memory channels storing repeater splits; one-touch repeater reverse and call channel recall; band, memory and partial memory auto-resume scanning and priority channel monitoring.

All memories store independent transmit and receive frequencies; seven hold any shift, and all accept automatically programmable  $\pm 600$  kHz shifts. When the optional FTS-12 Tone Squelch Unit is installed, any of 37 standard CTCSS (subaudible) tone frequencies can be displayed, selected and programmed into any memory channel for either silent monitoring or encode-only operation.

The microphone jack includes all signals needed for connection of a packet radio tnc (not supplied, European versions may require slight modification). Five different microphones are available for particular operating requirements. For the European versions, a 1750 Hz burst tone generator is built-in, and can be activated from the front panel or MH-14A8 Speaker/Mic (if not modified for packet). DTMF keypad microphone options include the MH-15C8 and the MH-15D8 with its own auto-dial memories.

Along with one microphone, the MMB-33 Reversible Mobile Bracket is supplied with the transceiver. For base station installations, the FP-700 AC Power Supply/External Speaker is optionally available.

Please read this manual carefully before installing or operating the FT-211RH.

## SUPPLIED ACCESSORIES

**MMB-33** Mobile Mounting Bracket  
 Power Supply Cable T9015610 with two 10A fuses, 2.8m  
 One of the microphones listed below.

## OPTIONS

**FTS-12** Tone Squelch Unit  
**SP-55** External Speaker  
**MH-10E8** Standard Hand Microphone  
**MH-10F8** Hand Speaker/Mic  
**MH-14A8** Hand Speaker/Mic w/T CALL Button  
**MH-15C8** HandMic w/DTMF keypad  
**MH-15D8** Hand Mic w/DTMF Autodialler Memory  
**MF-1A3B** Boom Microphone with flexible arm  
**YH-1** Headset (w/microphone)  
**SB-10** PTT Switch Unit for MF-1A3B or YH-1

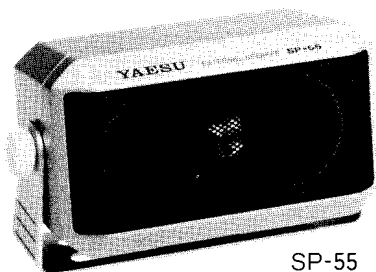

SP-55

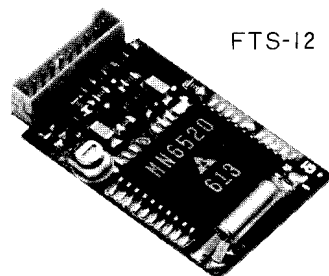

FTS-12

## SPECIFICATIONS

### GENERAL

**Frequency range** (MHz):  
 144 to 147.9995 (vers. A)  
 144 to 145.9875 (vers. B)  
 144 to 145.9995 (vers. D)

**Channel steps** (kHz):  
 5 & 10 (vers. A & D)  
 12.5 & 25 (vers. B)

**Standard repeater shift:**  
 ±600 kHz

**Mode of emission:**  
 G3E

**Antenna impedance:**  
 50 ohms, unbalanced

**Supply voltage:**  
 13.8 VDC ±15%, neg. ground

**Supply current:**  
 Transmit 45W: 9A  
 Transmit 5W: 3A  
 Receive: 700mA  
 Standby: 450mA

**Operating temp. range:**  
 -20 to +60 °C

**Case size** (WHD):  
 160 x 50 x 175mm

**Weight:**  
 Approx. 1.5 kg

### RECEIVER

**Circuit type:**  
 Double-conversion superheterodyne

**Intermediate frequencies:**  
 10.7 MHz & 455 kHz

**Sensitivity** (for 12dB SINAD):  
 better than 0.2uV

**Adjacent channel selectivity:**  
 better than 60dB

**Intermodulation distortion:**  
 better than 70dB

**Audio Output** (for 5% THD):  
 at least 1.5W into 8 ohms

### TRANSMITTER

**RF output power** (into 50 ohms):  
 5 watts (low), 45 watts (high)

**Frequency stability:**  
 better than ±10 ppm

**Modulation method:**  
 Variable reactance

**Maximum deviation:**  
 ±5 kHz

**Spurious emissions:**  
 at least 60 dB below carrier

**Audio distortion** (@3.5 kHz dev.):  
 less than 5% @1 kHz

Specifications subject to change without notice.

## CONTROLS & CONNECTORS

### FRONT PANEL

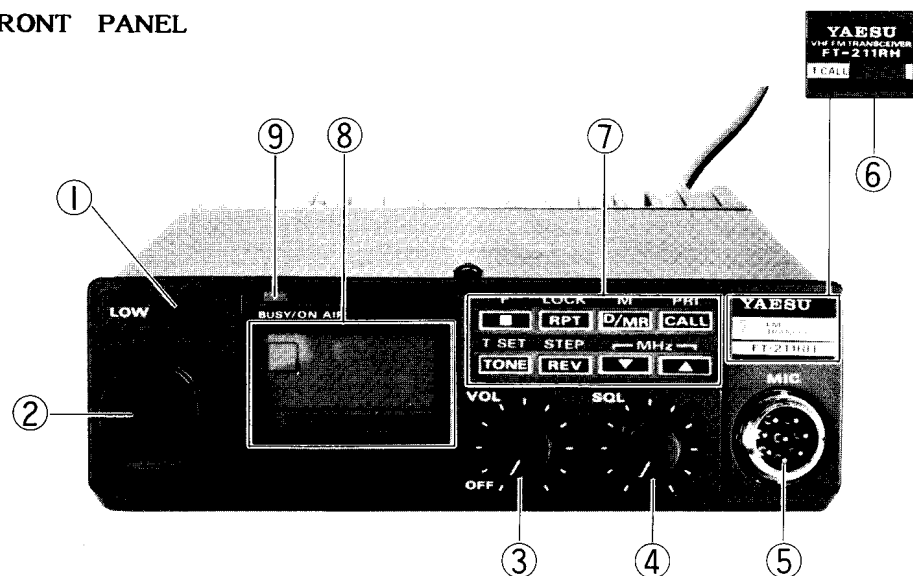

#### (1) LOW Power Output Button

Keep this button depressed whenever low power (5 W) is sufficient for communications.

#### (2) Rotary Selector

This 20-position detented rotary switch tunes the operating (or CTCSS tone) frequency or selects the memory channels, according to which function is selected by the keys on the front panel. This knob duplicates the functions of the Up and Down arrow keys for operating convenience.

#### (3) VOL (OFF) Control

This control adjusts the volume of the receiver. Turn it fully counterclockwise position (into the click stop) to turn the transceiver OFF.

#### (4) SQL Control

This control sets the threshold level at which received signals (or noise) open the noise squelch. For maximum squelch sensitivity when the FTS-12 Tone Squelch Unit is not installed, set this control from counterclockwise just to the point where noise is silenced (and the BUSY/ON AIR indicator on the front panel is off) when the channel is clear.

#### (5) MIC Jack

This 8-pin jack accepts microphone input and scanning control from the microphone or packet radio tnc. Pinout is shown on page 12.

#### (6) T CALL Button (European vers. only)

In the European version, this button activates the 1750 Hz Burst tone generator when pressed together with the PTT button.

#### (7) Function Keys

These eight keys select the various operating features of the transceiver during reception. A beep will sound whenever one of the keys is pressed. The labels on the faces of the keys indicate their primary functions, while the labels on the panel above the keys indicate alternate functions, which are activated by pressing the [F] key first, and then the other key within four seconds. For descriptive purposes in this manual, all key label references are enclosed in square brackets []. Throughout this manual, primary key functions are referred to by the labels on the keyfaces, except as follows:

■ is referred to as [BOX]

▲ is referred to as [UP]

▼ is referred to as [DOWN]

Alternate key functions are referenced by the alternate label (above the key), with '[F]+' in front of it to remind you to press

[F] first. For example, '[F]+[UP]' indicates that you should press the [F] key, followed by the  key within four seconds. All key functions are described in detail in the 'Operation' chapter, and summarized in the Operator's Quick Reference Charts.

**(8) LCD (Liquid Crystal Display)**

The display shows the selected operating conditions as indicated in the following diagram:

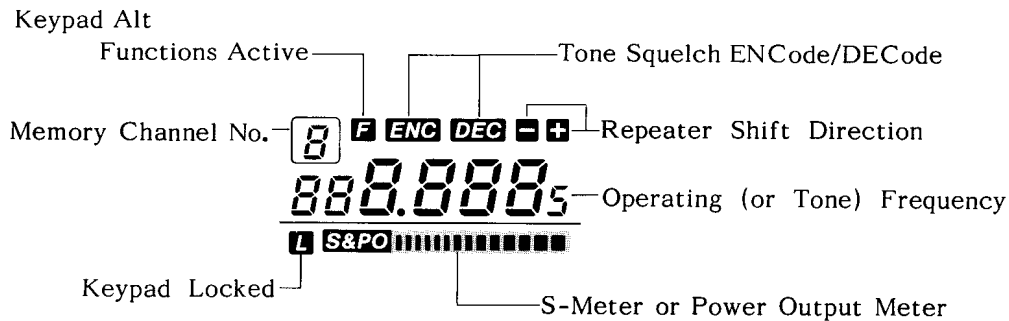

**(9) BUSY/ON AIR Indicator Lamp**

This LED indicator glows green when the noise squelch is open during reception, and red when transmitting.

**REAR PANEL**

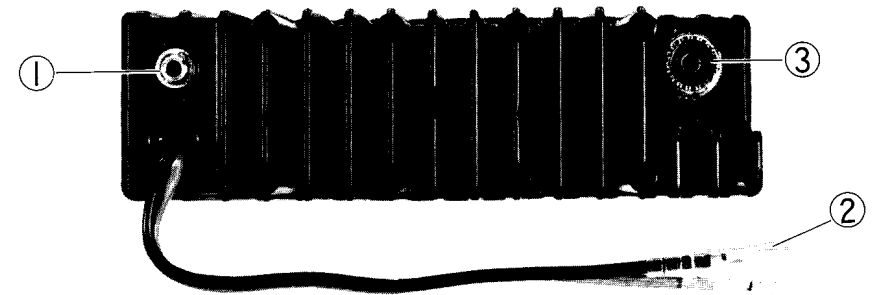

**(1) EXT SP (External Speaker) Jack**

This 2-contact mini phone jack accepts a 4- to 16-ohm external speaker such as the SP-55. When a plug is inserted into this jack the internal speaker is disabled.

**(2) 13.8VDC Cable Pigtail**

This is the power supply connection for the transceiver. Use the fused DC Cable supplied with the transceiver to make connection between this pigtail and the car battery or other DC power supply capable of at least 9 Amperes (continuous). Make certain that the red lead connects to the positive side of the supply.

**(3) ANT (Antenna) Jack**

Connect a 2m antenna to this type-M (SO-239) socket using 50-ohm coaxial cable and a type-M (PL-259) plug. Make sure the antenna is designed specifically for use at the operating frequency.

## INSTALLATION

### Antenna Considerations

The FT-211RH is designed for use with an antenna having an impedance near 50 ohms at the operating frequency. For optimum performance use a high-quality, carefully designed antenna. The antenna should be connected at all times when power is on, to avoid damage that can otherwise result if transmission occurs accidentally when no antenna is connected.

Another important consideration in installing the antenna for the FT-211RH is the feedline. For optimum performance use the shortest possible length of the best quality coaxial cable available, and be sure to use a properly matching fitting (type-M, PL-259) for the jack on the transceiver.

### Mobile Installation

The FT-211RH must only be installed in cars having a negative ground electrical system. The transceiver should be located where the display, controls and microphone are easily accessible, and should be securely affixed using the supplied MMB-33 mobile mounting bracket. The transceiver may be installed in any position without adversely affecting its performance, but it should not be mounted near a heater vent or where it could interfere with safe operation of the vehicle. Make sure that plenty of space is provided at the rear of the transceiver so that air can flow freely around the heatsink. Refer to the diagrams on the facing page for reversal of the front panel (if installing the transceiver overhead), and installation of the MMB-33.

- (1) Use the mounting bracket as a template for positioning the mounting holes, after determining the proper location with sufficient clearance for the transceiver. Use a 4.8mm (3/16") bit for drilling the holes. Secure the bracket with the screws, washers and nuts supplied, as shown in Figure 1.

(Continued on Page 10)

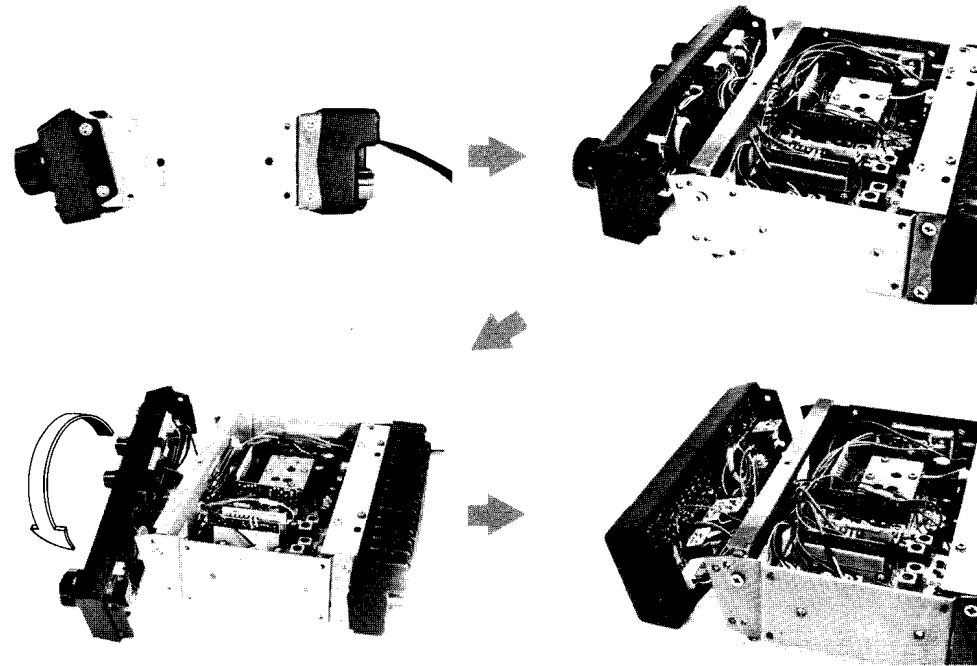

### Front Panel Reversal

The front panel may be installed so that it is angled either upwards (as supplied from the factory), or downwards, to accommodate various installation requirements. To reverse the front panel;

- (1) Remove the ten screws affixing the top and bottom covers, and remove the covers, using care not to strain the speaker wires.
- (2) Remove the four screws affixing the front panel, and gently separate it from the chassis.
- (3) Using care not to pull on the interconnecting wiring, turn the front panel over, and remount it.
- (4) Replace the top and bottom covers (now also reversed) and their ten screws.

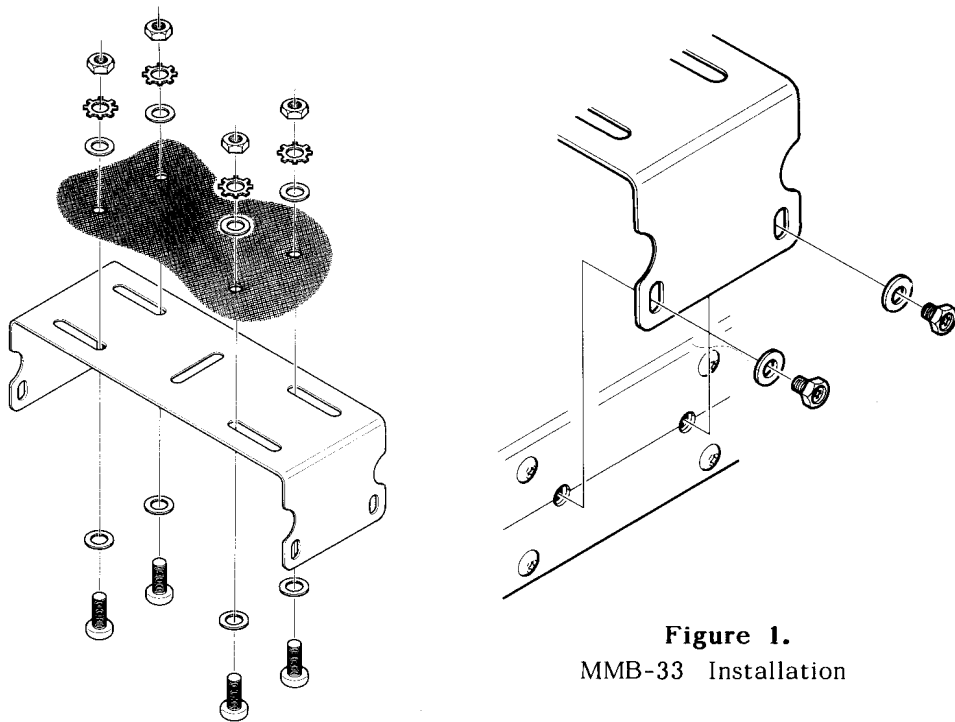

Figure 1.  
MMB-33 Installation

- (2) Position the transceiver in the bracket so that the holes in the side panels are aligned with those in the sides of the bracket, and bolt the transceiver into place with the supplied short screws and flat washers.

#### Mobile Power Connection

Before connecting the power cable the maximum battery charging voltage should be checked to ensure that it remains below 15V when the engine is run fast. If more than 15V, the voltage regulator of the car should be adjusted before connecting the transceiver.

Power connections should be made directly to the automobile battery using the supplied cable with 10A inline fuses. Connection to the cigarette lighter or other accessory circuit may cause the fuse to blow in that circuit. Connecting the supplied DC power cable to the battery independently of the rest of the automobile electrical system will minimize possible ignition noise pickup and excessive supply voltage drop during transmission.

Do not connect any power to the transceiver except via the supplied fused cable, and do not attempt to defeat or bypass the fuses - they are there to protect you and the equipment.

Connect the RED lead of the power cable to the POSITIVE (+) battery terminal, and the BLACK lead to the NEGATIVE (-) terminal. If it is necessary to extend the power cable, use #14 AWG or larger insulated, stranded copper wire, and in all cases use the minimum power cable length practicable to keep voltage drop minimal.

#### WARNING

**NEVER APPLY AC POWER TO THE REAR PANEL POWER JACK OF THE TRANSCEIVER. NEVER CONNECT DC VOLTAGE OF MORE THAN 15 VOLTS TO THE POWER JACK. ALWAYS REPLACE FUSES WITH 10A RATING. FAILURE TO OBSERVE THESE PRECAUTIONS WILL VOID THE WARRANTY.**

The SP-55 External Speaker is an optional accessory which allows the source of audio from the transceiver to be repositioned for optimum hearing. Especially practical for the noisy mobile environment, the SP-55 includes its own swivel-type mounting bracket, and is available from your Yaesu dealer. Also available to enhance safety and mobile operating convenience are the YH-1 Headset with miniature boom microphone, and the full size MF-1A3B boom microphone with flexible arm (both of which use the SB-10 PTT switch).

#### Base Station Installation

Mounting feet are supplied for installation on the bottom of the transceiver when used as a base station. A power supply capable of providing at least 9A continuously at 13.8VDC is required for operation from the AC line, and an external speaker is recommended. The FP-700 AC power supply is available from your Yaesu dealer for this purpose. Use the fused DC power cable supplied with the transceiver for making power connections, and connect the external speaker to the EXT SP jack on the rear panel.

## Packet Radio TNC Interconnections

Most popular packet radio tncs can be connected to the MIC jack of the FT-211RH as follows:

TNC Transceiver Jack	FT-211RH MIC Jack
Receiver Audio in	pin 4 (8 ohms, de-emphasized)
Squelch Ctrl in	pin 5* (open=8V, closed=0V 1 mA)
PTT (gnd=tx) out	pin 6
Transmit Audio out	pin 8 (400 ohms, pre-emphasized)

Use shielded cable for the audio lines, and keep the interconnecting cable as short as possible to avoid RF pickup.

\* in the European versions (B & D), this pin is wired for Burst control from the microphone. It can be modified as follows;

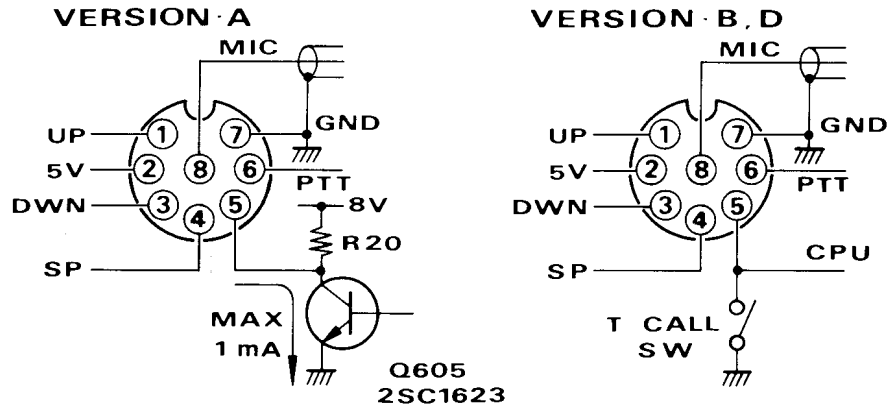

### Modification for Packet Radio

In the European versions (B & D), pin 5 of the MIC jack is wired in parallel with the T CALL button on the front panel to accept tone burst activation from the microphone. This feature is not needed for packet radio operation, however, so pin 5 may be re-wired to provide output of the Squelch detect line for packet radio tncs. In other versions (not equipped with a T CALL button or generator), pin 5 is already wired this way. The tone burst may still be activated after this modification in European versions, but only by the T CALL button on the front panel.

- (1) Remove the ten screws affixing the top and bottom covers, and remove the covers, using care not to strain the speaker wires.
- (2) Remove the four screws affixing the front panel, and gently separate it from the chassis, just enough to gain access to the CNTL Unit without straining the wiring.
- (3) Cut the green wire at pin 5 of the MIC jack on the rear of the CNTL Unit, and carefully tape the end of this wire out of the way.
- (4) Referring to the diagram below, connect a 150mm wire between the terminal post on the Main Unit and pin 5 of the MIC jack. Route this wire so that it will not interfere with installation of the covers.
- (5) Replace the front panel and its four screws, and then the top and bottom covers and their ten screws.

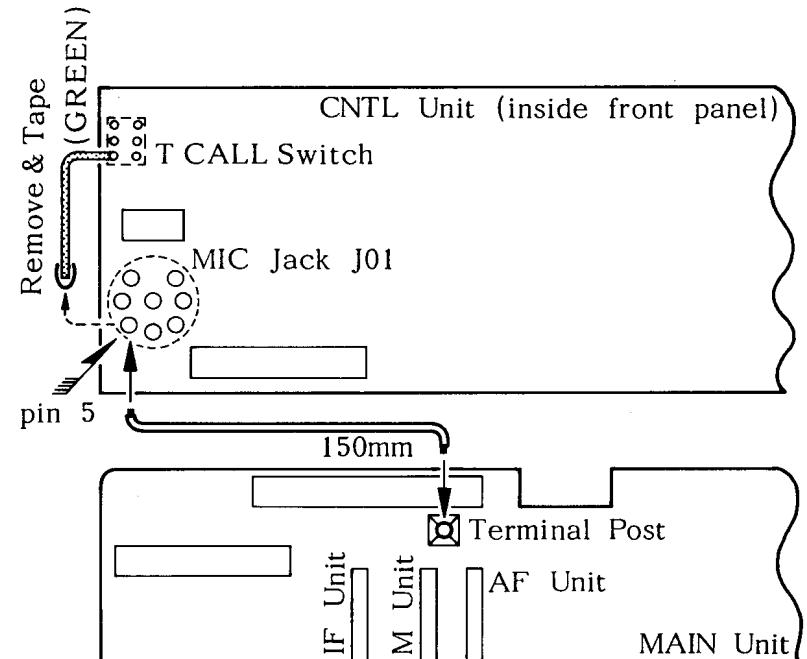



## FTS-12 TONE SQUELCH UNIT INSTALLATION

The FTS-12 provides either encode-only or encode/decode operation with 37 front panel selectable subaudible CTCSS tones, and is available for all versions FT-211RH, from your local Yaesu dealer. See the "Operation" section for functional details.

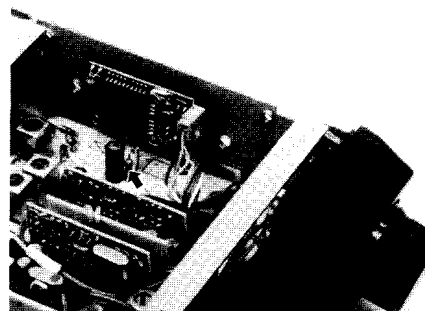

- (1) Disconnect the power cable at the rear of the transceiver, and remove the five screws affixing the bottom cover\*. Remove the cover carefully so as not to pull on the speaker wires, and lay the set upside down.
- (2) Locate the unconnected brown 10-pin connector at the front right corner on the Main Board just behind the tuning knob. Align the small tab on one side of this connector with the hole in one side of the FTS-12 connector, and mate these connectors.
- (3) Now locate the double-sided adhesive tape pre-installed on the inside of the side panel. Remove the paper covering from this tape, and press the FTS-12 against it as shown in the diagram below.
- (4) On the main circuit board near the FTS-12 mounting position, notice a 27-kilohm resistor (red, violet and orange bands). Cut the exposed lead of this resistor. If the FTS-12 is removed from the transceiver, this resistor must be reconnected.
- (5) Replace the bottom cover. The output tone level (VR1 on the FTS-12) is adjusted at the factory for the proper deviation, so no adjustment should be necessary.

\* If the front panel has not been reversed (ie., angles upwards), the bottom panel is the larger panel which includes the loudspeaker. Otherwise, the bottom panel is the smaller one.



CTCSS Tone Frequency (Hz)			
67.0	100.0	141.3	203.5
71.9	103.5	146.2	210.7
74.4	107.2	151.4	218.1
77.0	110.9	156.7	225.7
79.7	114.8	162.2	233.6
82.5	118.8	167.9	241.8
85.4	123.0	173.8	250.3
88.5	127.3	179.9	—
91.5	131.8	186.2	—
94.8	136.5	192.8	—

## Memory Cloning

All memory data stored in one transceiver can be moved to another by setting the CLONE switches on and connecting the MIC jacks together as indicated in the diagram below. Press the  key on the destination transceiver, and then the  key on the source transceiver. When transfer is completed, the data from Memory channel 0 in the source transceiver will appear on the destination transceiver if the operation was successful (otherwise, press the arrow keys again to repeat). When finished, return the CLONE switches to the OFF position.

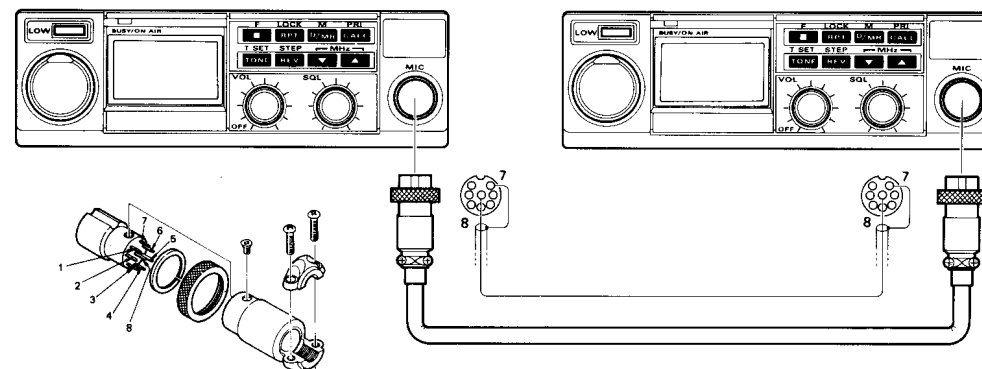
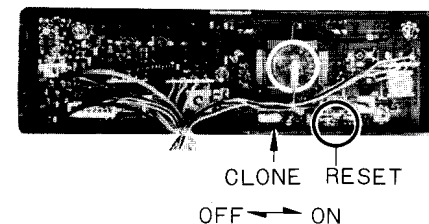

## OPERATION

This chapter describes the various transceiver functions in detail. After studying these descriptions, keep the FT-211RH Operator's Quick Reference Charts handy in case you need to refresh your memory.

### PRELIMINARY OPERATING INFORMATION

Before operating the transceiver, recheck power supply and antenna connections. Never operate the transceiver without an antenna.

Before proceeding, please read the chapter on Controls & Connectors, if you have not already, to familiarize yourself with the functions of the controls. Note especially the description of the terminology used in this chapter when referring to the keys on page 4.

When the function keys are pressed during reception, a single beep will sound if the command is accepted, or a double beep if the command is invalid. Except for certain special cases mentioned later, the keys are disabled during transmission.

If you have trouble getting the transceiver to work as described, see 'In Case of Problems' on page 24.

### SQUELCH SETUP

Before turning on the transceiver, set the SQL control fully counterclockwise. Now rotate the VOL control out of the click-stop and adjust for a comfortable volume on the noise or received signal. The BUSY/ON AIR indicator LED should glow green. If a signal is present, rotate the selector knob until a frequency is found where only noise is heard.

Rotate the SQL control clockwise just to the point where the noise is silenced and the LED is extinguished. If the SQL control is set further clockwise, sensitivity to weak signals will be reduced. Now, whenever a signal reaches the receiver that is strong enough to open the squelch, the indicator will glow green.

Note that while receiving, one or more bargraph segments may appear along the bottom of the display, indicating signal strength on the receiving frequency. This indication is not affected by the squelch setting, so even squelched signals will have some indication. If you notice more than one or two bargraph segments appearing while the squelch is still closed, try reducing the squelch control setting (if you want to hear weak signals).

### TRANSMITTING PROCEDURE

Press the LOW button to select low power output. When you wish to transmit, wait until the channel is clear (green LED off), and squeeze the PTT switch on the microphone. During transmission the BUSY/ON AIR indicator will glow red, and the bargraph will now show relative transmitter power output. Release the PTT switch to receive.

If more power is required, set the LOW button to the undepressed position. However, whenever communication is possible with low power, keep the LOW button depressed to minimize possible interference to other stations.

If using a version B or D (in Europe), press the T CALL button, either on the front panel or the MH-14A8 microphone, to transmit a 1750 Hz Burst Tone\* to access repeaters that require it.

---

\* If version B or D is modified for packet radio, the T CALL button on the microphone is disabled - use the button on the front panel for generating a Burst tone.

## FREQUENCY & STEP SELECTION

There are two ways to select your operating frequency: by turning the selector knob, or with the [UP] and [DOWN] keys\*. For continuous tuning, press and hold the [UP] or [DOWN] key for more than  $\frac{1}{2}$ -second. The transceiver must be in the Dial mode, which can be selected if in the Memory mode by pressing the [D/MR] key. If no Memory number is present in the upper left-hand corner of the display, the Dial mode is selected.

Channel steps are 5 or 10 kHz in versions A and D, and 12.5 or 25 kHz in version B. To change from one step size to the other for your version, press [F]+[STEP]\*. In version B, when 12.5 kHz steps are selected, a small .5 kHz digit is displayed at the right end of the frequency.

One-Megahertz giant steps are also available: just press [F] and rotate the selector knob (or press the [UP] or [DOWN] key and hold it for repeated stepping after pressing [F]).

## MEMORY STORAGE & RECALL

The FT-211RH offers ten programmable memory channels, numbered 0 through 9. When in the Memory mode, the Memory number appears in the upper left corner of the display. To store a frequency in memory:

- (1) Select the desired frequency in the Dial mode as described above,

- (2) Press [F]+[M] (the Memory number will blink) and select the desired Memory number for storage using the selector knob or [UP]/[DOWN] keys,
- (3) Press [D/MR] to store the Dial frequency into the selected Memory: the Memory number will disappear, and operation will continue in the Dial mode.

Once the Memory number starts blinking in step (2), you have a maximum of four seconds between knob selections or keystrokes until you press [D/MR] in step (3). If you time out, a memory number will be displayed after you press [D/MR]. Simply start again at step (2). Remember that when you store data in memory, the data previously stored in that channel (if any) is erased.

EXAMPLE: to store 145.00 MHz in channel 0

- (1) Press [D/MR] once if a Memory number is displayed, to select the Dial mode. Then use the selector knob or [UP] and [DOWN] keys to select 145.000 on the display.
- (2) Press [F]+[M] and then rotate the selector knob until '0' is displayed (blinking) at the upper left corner.
- (3) Press [D/MR]. There should now be no memory number displayed. If there is, you timed out.

To recall prestored memories press [D/MR], if necessary, to select the Memory mode (Memory number is displayed), and then rotate the selector knob or press the [UP]/[DOWN] keys, which select the memories when in the Memory mode (as opposed to frequency selection in the Dial mode). Only prestored memories are displayed: empty memories are skipped.

**Note:** Memory 0 is a special 'Call Channel Memory', which can be instantly recalled from any mode just by pressing [CALL]. Press [D/MR] when finished to return to the previously selected mode.

To exit the Memories and return to Dial mode, press [D/MR].

---

\* If nothing happens when you press a key, see if there is a small 'L' at the lower left corner of the display. If so, press [F]+[LOCK] to unlock the keys.

## REPEATER OPERATION

Before activating repeater shift, tune the Dial mode to the frequency on which you receive the repeater's signals. Then press [RPT]: once for '+' shift (to transmit 600 kHz above your receive frequency), and again for '-' shift (to transmit 600 kHz below your receive frequency). Pressing [RPT] again will return to simplex. '+' or '-' is displayed at the upper right corner when standard repeater shift is selected, and when the PTT switch is pressed to transmit, the displayed frequency will shift 600 kHz up or down, if in band. If the resulting transmit frequency is outside of the ham band, 'Err' is displayed instead.

You can check the frequency to be used for transmission without pressing the PTT switch: just press [REV], to reverse transmit and receive frequencies. If two beeps sound and the frequency does not change, the repeater shift is out-of-band. If both frequencies are in band, the '+' or '-' displayed at the upper right will blink, signifying that the transmit and receive frequencies are reversed. Using this REVERSE function also allows you to check the repeater input frequency to see if you can work a particular station direct (on a simplex frequency, of course). Press [REV] again to return to the original repeater shift.

Once standard repeater shift is activated in the Dial mode, it can be stored in any memory along with the frequency as described in the previous section. Then whenever that memory is recalled, the stored shift will be active (the '+' or '-' will be displayed). The REVERSE function cannot be stored in memory, although both [RPT] and [REV] can be pressed to temporarily change repeater operation on that memory: the new setting will not be stored. Repeater shift functions can also be activated temporarily on simplex memories, if required.

### Odd Splits

Memories 0 through 6 can also store an independent transmit frequency, for operation on repeaters with non-standard shift. To do this, first store the receive frequency as described previously. Then retune the Dial to the desired transmit frequency, and repeat

the storage procedure, but this time hold the PTT switch at the last step (when you press [D/MR] the last time while the Memory number is blinking). Now when you recall the memory, '-+' will be displayed together at the upper right. The [RPT] key will be disabled while operating on the odd-split memory, but the [REV] key will still function as described above.

## SCANNING

Before starting the scanner, make sure the SQL control is set to squelch off the noise on a clear channel. As with frequency selection, two different modes of scanning are available: band scanning or memory scanning. In both modes, scanning is manually activated and deactivated by the [UP] or [DOWN] key. Just press and hold the key for more than one half second to start the scanner. If the transceiver is in the Dial mode, band scanning will result. If a memory number is displayed, the transceiver is in the Memory mode, and only prestored memories will be scanned.

The scanner will pause on any channel where a signal is found strong enough to open the squelch, and will resume scanning about two seconds after the channel becomes clear. To stop the scanner, press any one of [UP], [DOWN], [D/MR] or the PTT switch.

For memory scanning, it is sometimes useful to be able to scan only certain memories. To use this feature, you can 'hide' any memory from the scanner (except Memory 0) without erasing it altogether. To hide a memory, press [F]+[M], select the memory to hide, and press [F]+[M] again while the Memory number is blinking. The display reverts to memory 0, and the hidden memory can no longer be selected or scanned.

To unmask a hidden memory, just repeat the same steps you took to hide it: press [F]+[M], select the Memory number to unmask, and press [F]+[M] again.

## PRIORITY CHANNEL MONITORING

The Priority function allows periodic checking for activity on Memory 1 while operating on the Dial frequency or other memories. When a signal appears on Memory 1 while receiving, operation will automatically shift to that memory, for as long as a carrier is received. If you transmit while the squelch is open on Memory 1, priority monitoring is cancelled and operation stays on Memory 1.

The squelch must first be preset, and the frequency to be monitored must be stored in Memory 1. Press [D/MR] to operate on the Dial, or else select the memory you want to operate on, and then press [F]+[PRI]. A 'P' will appear in the memory window at the upper left corner of the display, and about every five seconds the displayed frequency will shift to Memory 1 briefly while the receiver checks for a signal.

As long as no signal appears on Memory 1 to open the squelch, you can tune, transmit and receive on the Dial, or select and operate on other memories (although the memory number is not displayed). If a station you wish to talk with appears on Memory 1, press the PTT switch momentarily while receiving his signal, to stop priority checking on Memory 1.

Otherwise, to cancel priority monitoring, press [D/MR].

Note that you can use any other Memory as a priority channel in place of Memory 1 in the above procedure when operation is to be on the Dial.

## tone squelch operation

The FT-211RH can be used to silently monitor for calls on busy channels when the optional FTS-12 Tone Squelch Unit is installed. A general description and installation instructions are in the 'Installation' chapter.

To check or set the tone frequency, press [F]+[T SET]. The tone frequency will be displayed (in Hz), with a leading zero if that tone selection is a high-Q type. To change the tone frequency, rotate the DIAL selector or press [UP] or [DOWN] until the display shows the tone frequency you require (the display will step through the standard EIA tones). Press [TONE] to return to the operating frequency display when the tone frequency is selected.

To activate tone squelch functions press [TONE]. With one press, 'ENC' (encode) will be displayed and the tone generator will be activated for transmission. Press [TONE] again and both 'ENC' and 'DEC' (decode) will be displayed together as tone squelch is activated for both transmission and reception (only signals sending the matching tone frequency will open the squelch). Pressing [TONE] once more disables tone squelch features.

Once you have the tone squelch set up the way you want it, you can store it in memory (or the call channel) by pressing [F]+[M], select the memory to store, and press [D/MR]. Afterwards, to change a setting stored in memory, just recall the memory, reset the tone frequency or function, and press [F]+[M] and [D/MR].

## IN CASE OF PROBLEMS

FT-211RH operation is not complicated, but it is still possible to get lost, at least until you have had the chance to learn the various functions of the keypad and display. If the display shows nothing at all, check the power switch (VOL control), and the power supply connections.

Fortunately, the display includes enough symbols and function indicators to let you know what is going on as long as power is applied, so it is well worthwhile to study the display diagram on page 6 carefully. For example, if the frequency display changes unexpectedly when you transmit (or if 'Err' appears), check for a small '+' or '-' at the upper righthand corner. Also, if only a few seemingly non-sensical digits appear, press [TONE] to disable the tone squelch setting feature.

Attempting an illegal command (such as activating the tone squelch when the FTS-12 is not installed), will cause two beeps to sound. If pressing a key appears to do nothing, first check for a small 'L' at the lower left, which indicates if the keypad is locked. If so, press [F]+[LOCK] to unlock the keys. If the 'L' is not there, press [D/MR], which will terminate any partially entered commands. If you still cannot enter data, check the ON AIR indicator to see if it is red, indicating that the transceiver is transmitting. Releasing the PTT switch should return the set to receive. If still nothing happens, switch the transceiver off, and then back on.

To avoid confusion resulting from inadvertent key presses, set the keypad lock on (press **F+LOCK**) if you set the transceiver down while it is on, and then remember to set the lock back off when you wish to enter data.

